

2024 | 2025

Storage, picking and transport containers

Individual solutions
for storage and transport

ssi-plastic.com



SSI SCHÄFER

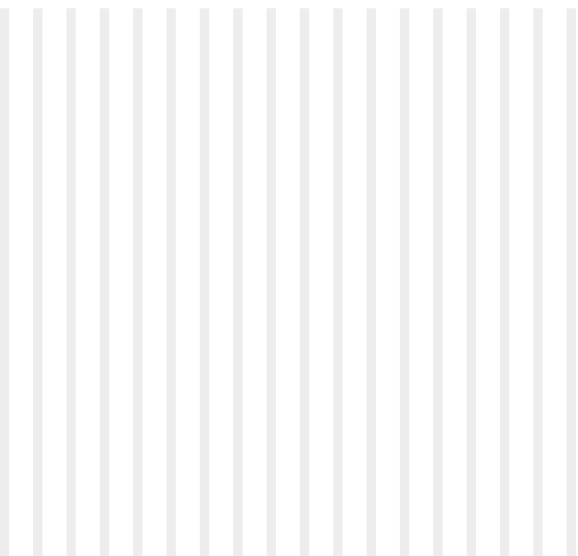
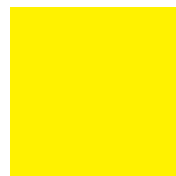
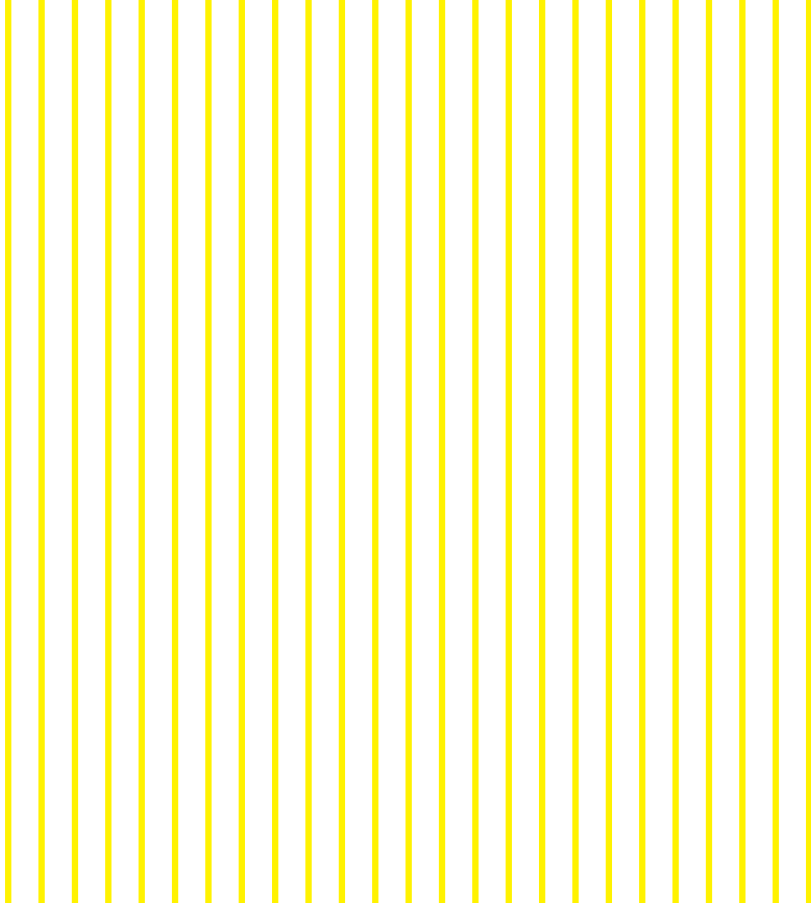

General Terms and Conditions of Business (Ts & Cs) of SSI SCHÄFER PLASTICS GMBH

Validity

The following Terms and Conditions of Business shall apply only to contractors, legal entities and public special resources.

I. Pursuance

- Our deliveries and services are based exclusively on these conditions, in the absence of separate contractual agreements in written form, excluding the validity of the buyer's terms of business, unless these have been expressly accepted.
- These conditions shall also apply to ongoing business relations without direct reference to future transactions, if the buyer has previously agreed to them by means of a purchase order confirmed by us.
- All quotations are non-binding unless explicitly stated as binding.
- Orders become only binding upon our order confirmation.
- Verbal explanations from our staff, subcontractors or other representatives only form part of the contract upon written confirmation.
- Should any individual clause be, or become, ineffective, the effectiveness of the remaining clauses shall remain unaffected.

II. Prices

- The prices apply for delivery ex works, excluding packing and freight charges, plus the relevant value added tax in Euro at the rate valid on the day of delivery.
- Should critical cost factors, e. g. raw material costs, change substantially 6 weeks after a quotation was provided or an order confirmation was issued, we shall be entitled to an appropriate adjustment of the prices previously agreed.
- No obligation to previous price agreements exists for follow-up orders.
- For order values under € 200, a low-quantity surcharge of € 20 shall apply.

III. Terms of payment

- A payment shall be deemed received on the day that the amount clears in our bank account.
- We reserve the right to refuse cheques or bills, whereby cheques and re-discountable bills are accepted only in payment of debt and all associated costs are paid by the buyer.
- The buyer's rights of lien or retention exist only to the extent that its demands are undisputed or valid in law.
- In the event of late payment, the legal rate of interest of 8 %, calculated in line with the relevant base interest rate of the European Central Bank, shall apply, unless we are able to prove a higher damage level or the buyer can prove a lower damage level.
- All amounts outstanding shall become due immediately and in full following the long-term non-observance of terms of payment or if circumstances are brought to our attention which justify serious doubts about the credit-worthiness of the buyer.

In addition, we shall be entitled in such a situation to make deliveries dependent on the receipt of advance payments or the putting into place of appropriate collateral and/or to withdraw from the contract after a reasonable period has passed.

IV. Delivery time

- The observance of binding, agreed delivery times by us – regardless of correct and prompt incoming deliveries received by us – shall depend on the fact that all commercial and technical queries between the contracting parties relating to the order execution have been clarified, and in particular that the buyer complies with all agreed (collaborative) obligations in a timely manner, e. g. obtaining the necessary official certificates and authorisations, design approvals, availability of the installation site appropriate to the contractual purposes, additional orders of material, personnel or other equipment, or the release of agreed pre-payments.
- In case of a contract modification after the sending of our order confirmation, only the date of delivery specified in the new order confirmation shall apply.

3. On-time delivery is regarded as fulfilled on notification of readiness to dispatch, if the dispatch process proves to be delayed or not possible for reasons outside our responsibility.

- If an agreed time for delivery is exceeded due to our own fault, neither deliberately nor as a result of gross negligence, and damages arise for the buyer due to this delay, then the buyer shall be entitled to liquidated damages for delayed completion, in full satisfaction of our liability for the said failure, upon expiration of an appropriate additional grace period, of 0.5 % per week, however, not exceeding a total of 5 % of the value of that part of the complete delivery which could not be used due to the delay and/or as stipulated.
- No rescission of the buyer shall be permissible, in case of acceptance default.
- The disregard of the agreed delivery time due to acts of God, labour disputes or other circumstances outside our influence shall entitle us to an appropriate delivery time extension. Apart from that, we shall in this case be entitled to rescind the contract in total or in part, regarding the non-fulfilled part of the contract, even if the aforementioned circumstances arise during the delay period or with regard to a subcontractor.
- An agreed time for delivery shall also be extended by the duration of the delay of the buyer's contractual obligations.

V. Dispatch, freight, packing

- If the goods are being dispatched in accordance with the buyer's request, then the risk shall be deemed transferred to the buyer as soon as the consignment leaves our delivery works or depot even if the delivery is not being dispatched from the place of performance.
- If the delivery of goods ready for dispatch is being delayed due to reasons not within our control, the risk shall be deemed transferred to the buyer with the sending of an announcement of readiness for dispatch either in writing or by fax.
- If the buyer does not immediately accept delivery of goods after completion and/or dispatch notification, or the dispatch is delayed in accordance with the buyer's wishes, we shall be entitled to charge the buyer for storage expenses.

VI. Retention of title

- All deliveries shall remain our property until paid for in full. If any amounts remain outstanding on the account, the title of ownership to the deliveries (goods subject to retention of title) shall be retained as security against the balance due.
- The customer may modify or process goods from us as manufacturers pursuant to section 950 of the German Civil Code, provided that we acquire a proportion of the ownership title, without giving rise to any obligations on our part. The customer shall be required to carefully secure and store the goods for us.
- The buyer shall be permitted in the usual course of business to re-sell the goods to which retention of title applies under the condition that he likewise agrees upon an appropriate retention of title with its customers. However, the buyer shall not be entitled to pledge such goods, transfer them by way of security or assign them for security purposes.
- The customer shall hereby transfer and assign to us, and we hereby accept such transfer and assignment of, any and all claims under the sale of the conditional goods owned solely or jointly by us, together with any and all secondary rights and security interests.
- In the event of an application to commence bankruptcy proceedings relating to the buyer's property, we shall be entitled to withdraw from the contract and to request the immediate return of the goods supplied.

VII. Liability for material defects

- Any and all information relating to the specifications of the goods and any data relating to technical standards in catalogues, brochures, illustrations and price lists, and any references to performance specifications, shall be understood solely as a description of the goods, and shall only represent an assurance of specific features in the spirit of sections 443, 444 of the German Civil Code when specifically agreed in writing.

2. Regarding consultations with the buyer outside of existing contract obligations, we shall accept liability regarding the operability and suitability of the goods only with confirmation in writing.

- The warranty period shall be limited to a period of twelve months, commencing upon the date transfer of risk, save for any longer mandatory periods, according to clauses 438 I No. 2, 479 I and 634 a I No. 2 of the German Civil Code.
- Any damage notified immediately in writing, and incurred due to circumstances arising before the transfer of risk, will be repaired or replaced with a damage-free item at our discretion as part of our supplementary performance obligations.
- In the event that we are in default with delivering substitute goods or if we fail to perform the delivery correctly, the customer shall, after having set a reasonable grace period, be entitled to rescind the contract or reduce the purchase price; additional claims, especially claims for damages and incurred expenses due to defects shall be subject to section VIII.

6. Liability shall be waived if operational or maintenance instructions of the seller such as an inappropriate installation site, are not being followed by the buyer or a contracted third party, changes are implemented to the products, parts are replaced or consumable materials applied which do not match the original specifications, or normal wear and tear.

- Colour deviations in follow-up deliveries, as well as faults due to faults in supplied parts, are excluded from any such liability, unless a specific warranty has been provided by us to this effect, or the fault was already obvious to us when the supplied part was received.
- Rights of recourse according to clauses 478 and 479 of the German Civil Code only apply insofar as the utilisation of these by the consumer are justified and only to the extent as provided for by law, but not in respect of goodwill agreed with the supplier, and presuppose that the party entitled to recourse has met its own obligations, in particular in respect of notification of defects.

VIII. Liability

In all cases in which, notwithstanding the above terms and conditions, we (including any of our related corporations within the SSI SCHÄFER-Group, e.g. any subsidiary, affiliated or holding company or any corporate entity in which any such company has a 10 % or larger share-holding from time to time), shall be liable on the grounds of contractual or legal bases for claims to effect compensation for damage or expenditures only insofar as we, a managing executive or vicarious agent can be accused of intent, gross negligence or injury to life, body or health.

In the event of minor negligence, we shall accept no liability for indirect damage, consequential damages or loss of profit.

Strict liability in accordance with the product liability act is not affected by this. Liability for negligent infringement of major contractual obligations is also unaffected by this; however, except for cases as per clause 1, liability is limited to the foreseeable loss or damage which is typical of the contract.

If our liability is exempted or restricted by this clause, this shall also apply to the personal liability of our employees and freelance staff.

The aforementioned regulations shall not involve modification of the burden of proof to the detriment of the buyer.

IX. Place of performance and place of jurisdiction

- The place of performance for deliveries and payment shall be, unless agreements stating otherwise exist, D-57290 Neunkirchen/Siegerland, Germany.
- The relationships between the buyer and ourselves are subject solely to the laws of the Federal Republic of Germany. The UN Treaty of 11th April 1980 (Contract for international sale of goods) shall not apply to the sale of goods is excluded.
- Venue shall be Siegen, Germany or, at our discretion the buyer's headquarters.

A

Our expertise: Plastic containers

Our expertise: Plastic containers

B

Storage & transport containers for manual handling

Storage & transport containers for manual handling

C

Containers for semi- and fully automated systems

Containers for semi- and fully automated systems

D

Space-saving containers

Space-saving containers

E

Containers for storing small parts

Containers for storing small parts

F

Industry solutions for the automotive industry

Industry solutions for the automotive industry

A

Our expertise: Plastic containers

- About us from page **A2**
- Shaping the future together from page **A4**
- Development expertise from page **A6**
- Quality is important to us from page **A8**
- Chemical resistance list from page **A9**
- A little materials science from page **A10**
- Container identification options from page **A12**

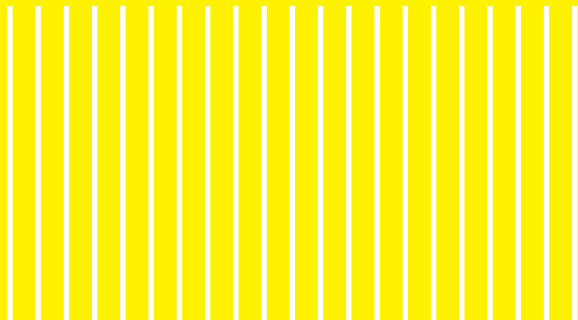

Our expertise: Plastic containers

Storage & transport containers
for manual handling

Containers for semi- and
fully automated systems

Space-saving containers

Containers for storing small parts

Industry solutions
for the automotive industry

SSI SCHÄFER Plastics

The internationally operative SSI SCHAEFER Plastics is a leading supplier of innovative container systems and constructive packaging, as well as waste technology and recycling solutions, and is part of the SSI SCHAEFER Group.

As an independent division with headquarters in Neunkirchen (Germany), SSI SCHAEFER Plastics employs more than 1,000 people worldwide.

In addition to the continuous development of the existing product portfolio, the development of new approaches to the digitisation of waste management and our aim of ensuring high environmental compatibility of the products in order to conserve resources and reduce the CO₂ footprint are firmly anchored in the company strategy.



Production sites & sales offices

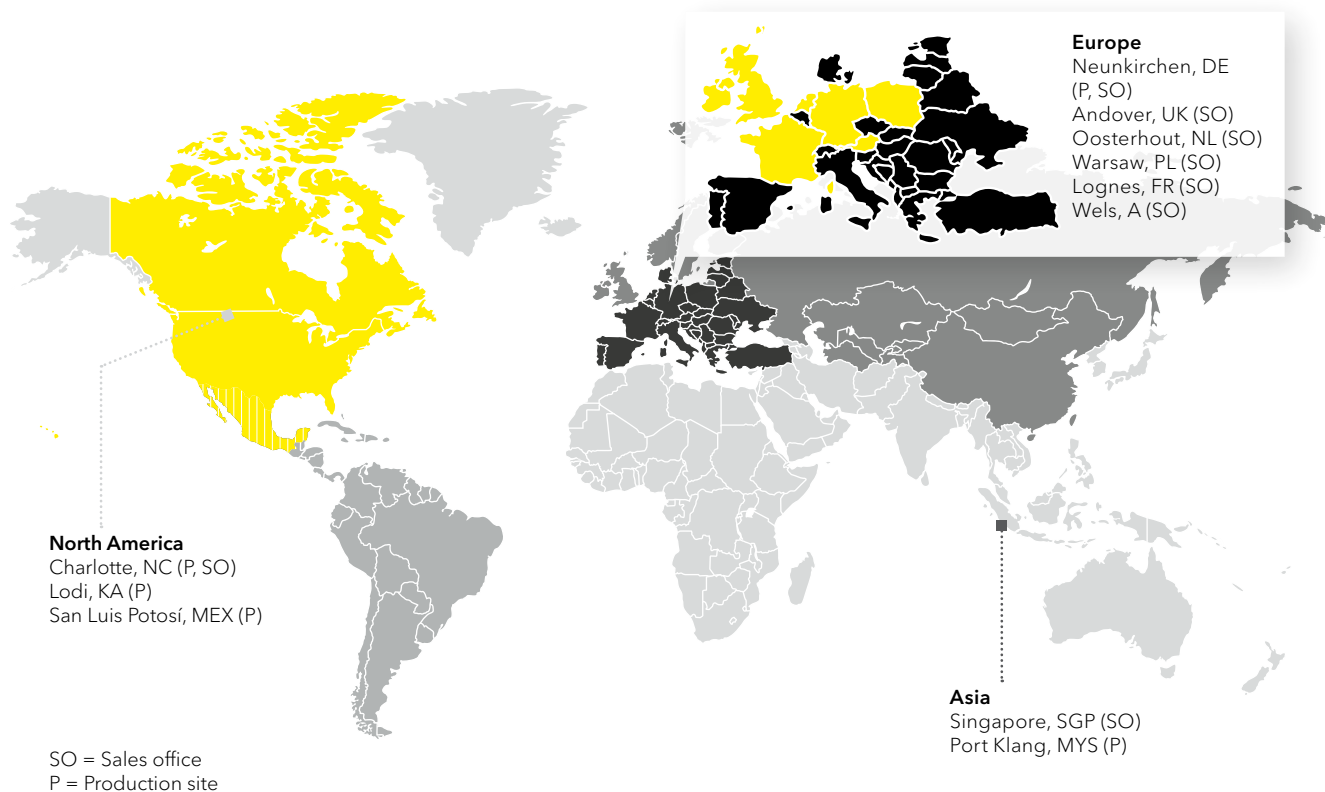

Our expertise: Plastic containers

Storage & transport containers for manual handling

Containers for semi- and fully automated systems

Business units & products

Waste technology & digital solutions



Constructive packaging



Container systems



Space-saving containers

Containers for storing small parts

Industry solutions for the automotive industry





Shaping the future together

Sustainability is our top priority, because this is the only way we can shape a future together.

We are therefore happy to advise you on durable, resource-saving reusable containers that help to reduce your CO₂ emissions and your energy and water consumption as well as process and investment costs.

Please contact us if you would like us to support you on your way to a more sustainable future.

Our expertise: Plastic containers

Storage & transport containers for manual handling

Containers for semi- and fully automated systems

Space-saving containers

Containers for storing small parts

Industry solutions for the automotive industry

From the initial idea to the ideal container

The beginning

- The process begins with an initial meeting with the customer, in which we jointly determine, discuss and record the requirements for the new product

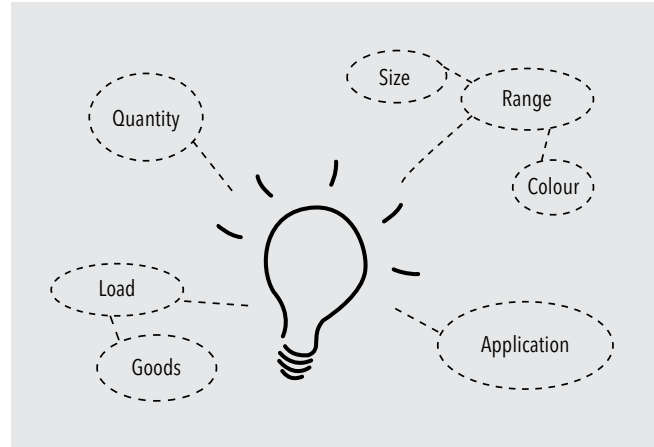

Development

- To develop the container, we use a computer to produce a 3D drawing of the product
- The three-dimensional representation provides a first impression of the article to be developed in a realistic image
- In addition to functionality (e.g. dimensional stability, protection of the contents, ease of cleaning and accuracy of fit), the design of the container is also of particular importance here



FDM prototypes

- If required, we can produce a three-dimensional FDM prototype made of plastic for an initial assessment of the dimensions, shape and position of the product
- Fused deposition modelling (FDM) is a manufacturing process from the field of rapid prototyping
- The plastic for the container is melted in a 3D printer and applied layer by layer in a three-dimensional structure according to the design data



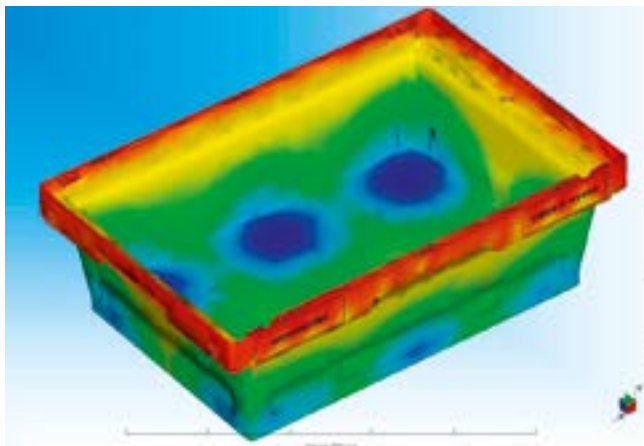

Moldflow

- Moldflow simulations allow us to address any potential production issues during the development of the moulded product
- The simulation provides critical insights into the moulded part design and offers reliable information for the development of an optimum tool concept as well as criteria for the selection of the necessary injection moulding machine or injection parameters



Initial sampling

- During the initial sampling phase, we check the specified criteria of the container together with the customer
- Initial sampling offers customers the opportunity to carry out their own tests and inspections with the container at an early stage. Any resulting change requests are then implemented by us.



Series production

- For series production, we use our own machines to manufacture the required quantities of the new container at the customer's request
- With our own machinery, we are always at the cutting edge of technology

Quality is important to us

Certification according to DIN ISO 9001: 2000

As the global market leader in the intralogistics industry, we have been developing and producing high-quality systems, components and solutions that make our customers more competitive for decades. This also applies to our plastic containers, as quality is a decisive purchasing criterion here.

Our success in this field is no coincidence, but the result of continuous optimisation. To this end, we have been using a sophisticated quality management system for years, with the help of which we control the internal processes that lead to quality improvement and thus underpin our claim to provide outstanding services. Production is always carried out according to defined and tested parameters. Further visual inspections are carried out by the machine operators, while the shift supervisors supplement the

process with regular checks of dimensions, wall thicknesses and weights. All inspections and measures carried out are recorded in corresponding reports.

While many companies only promise their customers high quality and advertise this to the public, we have our quality management independently audited, because for us, quality means much more than just fulfilling standards. Our aim is to be a reliable and trustworthy partner for our customers and suppliers, because long-term business relationships for mutual benefit are important to us.

This is why we pursue the following quality objectives in particular:

- Continuous further development of our quality management system
- Improvement of internal and external communication
- Scheduled and ongoing training of employees
- Quality work in all areas
- Products and services that meet our customers' requirements
- Further increase in customer satisfaction

Moulded plastic parts - sample tolerances according to DIN ISO 20457

Tolerance group TG7 for PE & PP

Nominal size range	over	30	50	80	120	180	250	315	400	500	630	800
	up to	50	80	120	180	250	315	400	500	630	800	1,000
Tolerance group TG7	TS	± 0.50	± 0.60	± 0.90	± 1.25	± 1.45	± 1.60	± 1.80	± 2.00	± 2.20	± 2.50	± 2.80
	NTS	± 0.60	± 0.90	± 1.25	± 1.45	± 1.60	± 1.80	± 2.60	± 2.20	± 2.50	± 2.80	± 3.30

Tolerance group TG6 for ABS & PS

Nominal size range	over	30	50	80	120	180	250	315	400	500	630	800
	up to	50	80	120	180	250	315	400	500	630	800	1,000
Tolerance group TG6	TS	± 0.31	± 0.37	± 0.57	± 0.80	± 0.93	± 1.05	± 1.15	± 1.25	± 1.40	± 1.60	± 1.80
	NTS	± 0.37	± 0.57	± 0.80	± 0.93	± 1.05	± 1.15	± 1.25	± 1.40	± 1.60	± 1.80	± 2.10

Abbreviation	Explanation	Tolerance group
PE	Polyethylene mouldings (unfilled)	TG7
PP	Polypropylene mouldings (unfilled)	TG7
ABS	Acrylonitrile-butadiene-styrene mouldings	TG6
PS	Polystyrene mouldings	TG6
TS	Tool-specific dimensions	
NTS	Non-tool-specific dimensions	

Chemical resistances

Chemical	Concentration	HDPE	PP	PS	Chemical	Concentration	HDPE	PP	PS
Acetaldehyde		3/3	3/4	4/4	Heating oil		3/3	1/3	3/4
Acetamide	saturated	1/1	1/1	1/1	Heptane, n-		2/3	2/4	4/4
Acetic acid	50%	1/1	1/1	2/2	Hexane		2/3	2/3	4/4
Acetone		1/1	1/3	4/4	Hydrazine hydrate	aqueous	1/1	1/1	0/0
Acetonitrile		1/1	3/4	4/4	Hydrobromic acid	50%	1/1	1/2	4/4
Acetophenone		0/0	1/3	0/4	Hydrochloric acid	20%	1/1	1/1	1/1
Acetylene	100%	1/0	1/0	0/0	Hydrocyanic acid	aqueous	1/1	1/1	1/0
Acrylonitrile		1/1	3/4	4/4	Hydrofluoric acid	50%	1/1	1/1	4/4
Adipic acid	saturated	1/1	1/1	1/1	Isopropanol (isopropyl alcohol)	techn. pure	1/1	1/1	2/2
Allyl alcohol	96%	1/3	2/2	2/4	Isopropyl acetate		1/2	2/3	4/4
Aluminium chloride	10%	1/1	1/1	1/1	Iodine (J) tincture		1/3	1/2	3/3
Aluminium oxide	fest	1/1	1/1	1/1	Kerosene		2/2	3/3	4/4
Amino acid		1/1	1/1	1/1	Lactic acid	85%	1/1	1/2	2/2
Ammonia	25%	1/1	1/1	2/3	Lanolin	techn. pure	1/3	1/3	1/1
Ammonium chloride	aqueous	1/1	1/1	1/1	Lead acetate	aqueous	1/1	1/1	1/1
Ammonium hydroxide	5%	1/1	1/1	1/3	Lubricating oils		1/3	3/0	0/0
Ammonium oxalate		1/1	1/2	1/1	Machine oil	100%	0/0	1/3	0/0
Ammonium phosphate	any	1/1	1/1	1/1	Mentho	100%	1/3	1/3	4/4
Ammonium sulphide	any	1/1	1/1	0/0	Mercury	pure	1/1	1/1	1/1
Amyl acetate (pentyl acetate)		1/2	3/4	4/4	Mercury chlorides		1/1	1/1	1/3
Amyl alcohol		1/1	1/1	1/3	Metal salts		1/1	1/1	2/2
Aniline		1/2	2/3	4/4	Methanol (methyl alcohol)		1/1	1/1	3/4
Antifreeze (motor vehicles)		1/1	1/1	1/1	Methoxyethyl oleate		1/1	1/2	4/4
Aqua regia		4/4	4/4	4/4	Methyl acetate	100%	1/0	1/3	4/4
Barium chloride	saturated	1/1	1/1	1/1	Methyl ethyl ketone		1/3	1/3	4/4
Benzaldehyde		1/3	1/4	4/4	Methylene chloride		4/4	3/4	4/4
Benzene		3/4	3/4	4/4	Mineral oil		1/1	1/3	1/1
Benzoic acid	saturated	1/1	1/3	2/2	Monochloroacetic acid		1/1	1/2	2/4
Benzyl alcohol		3/4	4/4	4/4	Nitric acid	50%	2/4	3/4	4/4
Boric acid	10%	1/1	1/1	1/2	Nitrobenzene		3/4	2/4	4/4
Brake fluid		1/0	1/1	3/0	Octane, -n		1/1	1/1	4/4
Bromine		4/4	4/4	4/4	Oils and fats	vegetable	1/3	1/3	3/0
Bromobenzene		3/4	4/4	4/4	Oxalic acid		1/1	1/1	1/1
Butadiene		3/4	4/4	4/4	Perchloric acid		2/4	2/4	2/3
Butanol	techn. pure	1/1	1/2	1/0	Perchloroethylene		4/4	4/4	4/4
Butyl acetate		1/2	3/4	4/4	Petroleum		2/3	3/4	4/4
Butyric acid		3/4	4/4	4/4	Petroleum	techn. pure	1/3	1/3	4/4
Calcium chloride	aqueous	1/1	1/1	1/1	Phenol	100%	2/3	1/2	4/4
Calcium hydroxide	conc.	1/1	1/1	2/2	Phenylhydrazine	techn. pure	3/0	3/4	0/0
Calcium hypochlorite	saturated	1/1	1/1	2/3	Phosphoric acid	85%	1/1	1/2	1/2
Calcium sulphate	saturated	1/1	1/1	1/0	Photo developer		1/3	1/2	0/0
Carbazole		1/1	1/1	1/1	Photofixing baths		1/0	1/1	0/0
Carbon dioxide		1/1	1/1	0/0	Plasticiser		1/3	1/3	0/0
Carbon disulphide		4/4	4/4	4/4	Potassium hydroxide	50%	1/1	1/1	1/1
Carbon tetrachloride		3/4	4/4	4/4	Potassium perchlorate	saturated	1/1	1/1	0/0
Cellosolve acetate		1/1	1/2	4/4	Potassium permanganate		1/3	1/1	1/3
Chlorinated water		3/0	3/4	4/4	Propane	gaseous	3/4	2/4	4/4
Chlorine	10% wet	3/4	4/4	4/4	Propylene glycol		1/1	1/1	1/1
Chlorobenzene		3/4	3/4	4/4	Propylene oxide		1/1	1/2	4/4
Chloroform		3/4	2/3	4/4	Pyridine		1/3	3/3	4/4
Chromic acid	10%	1/1	1/1	1/1	Resorcinol	saturated	1/1	1/1	2/3
Citric acid	10%	1/1	1/1	1/2	Salicylaldehyde		1/1	1/2	4/4
Cresol		3/4	2/3	4/4	Salicylic acid	saturated	1/1	1/1	1/2
Cyclohexane		3/4	3/4	4/4	Silver acetate		1/1	1/1	2/2
Decahydronaphthalene		1/2	2/4	4/4	Silver nitrate		1/1	1/2	2/3
Dibutyl phthalate		1/3	2/2	4/4	Sodium acetate	any	1/1	1/1	2/2
Dichlorobenzene		3/3	3/4	4/4	Sodium carbonate		1/1	1/1	0/0
Diethyl ether		3/4	4/4	4/4	Sodium chloride	any	1/1	1/1	1/1
Diethylbenzene		3/4	4/4	4/4	Sodium dichromate		0/0	1/1	1/1
Dimethylformamide		1/1	1/1	4/4	Sodium hydroxide	50%	1/1	1/1	2/2
Dioxin 1.4		2/2	3/3	4/4	Sodium hydroxide solution	30%	1/1	1/1	1/0
Ethanol	50%	1/1	1/1	1/0	Sodium hypochlorite	15%	1/1	1/1	1/1
Ether		3/4	4/4	4/4	Sodium hypochlorite	50%	3/3	3/3	0/0
Ethyl acetate		1/3	1/3	4/4	Stearic acid	crystals	1/3	1/3	1/2
Ethyl acrylate	100%	4/4	4/4	0/0	Sulphides		2/3	(2)	4/4
Ethyl alcohol	96%	1/1	1/1	3/4	Sulphur dioxide	moist	1/1	1/3	3/4
Ethyl benzene		2/3	3/4	4/4	Sulphuric acid	95%	3/4	3/4	4/4
Ethyl chloride		3/3	3/4	4/4	Tetrahydrofuran		3/4	3/4	4/4
Ethyl ether		3/0	4/4	4/4	Thionyl chloride	techn. pure	4/4	4/4	4/4
Ethylene cyanoacetate		1/1	1/1	2/4	Trichloroethylene	100%	3/4	4/4	4/4
Ethylene glycol		1/1	1/1	1/1	Turpentine oil		2/2	4/4	4/4
Ethylene oxide		2/3	3/3	4/4	Urea		1/1	1/1	1/2
Fluoride		1/1	1/1	2/2	Vinyl	techn. pure	0/0	(3)	0/0
Fluorine		4/4	4/4	4/4					
Formaldehyde	40%	1/2	1/2	4/4					
Formic acid	98 - 100%	1/1	1/3	3/4					
Glacial acetic acid		0/0	1/3	0/0					
Glucose	any	1/1	1/1	1/1					
Glycerine	any	1/1	1/1	1/1					

Two values are given for each material, left number = value at +20 °C, right number = value at +50 °C.

1 = high resistance / suitable; 2 = average resistance / suitable; 3 = limited resistance; 4 = no resistance; 0 = no data available.

Details without guarantee. No legal liability accepted.

Materials

When manufacturing our containers, we attach the utmost importance to the quality of our products. Durability, robustness, stability, flexibility - these are just some of the aspects that play a decisive role in our choice of materials. This is why we only use tried-and-tested, high-quality plastic materials such as high-density polyethylene, polypropylene and polystyrene, which fulfil a wide range of criteria to match the customer's requirements. We also have the option of equipping the containers with additional functions depending on the intended use and customising them to our customers' requirements.

ESD protection plays a special role here. More and more products today contain extremely sensitive electronic parts that are transported in containers.

The challenge lies in preventing damage caused by electrostatic discharge, as reliable protection is generally far cheaper than repairs. Accordingly, it is essential to use materials that do not allow electrostatic charges to occur

or dissipate them when they do occur. The development of modern materials, especially polymers, has made static electricity a normal phenomenon.

Our ESD storage and transport systems prevent possible electrostatic discharge. They protect the goods in resilient plastic containers against mechanical damage, dirt and moisture.

Containers made of electrostatically conductive materials can also be manufactured from electrostatically dissipative materials on request. This ensures reliable protection for all electronic component.

HDPE

- Stands for high-density polyethylene
- Belongs to the group of polyolefins and is a semi-crystalline, thermoplastic material
- Has a high resistance to acids, alkalis and other chemicals
- Is supplied as a colourless plastic granulate to which certain additives are added as required
- The tested and approved raw material is odourless, skin-friendly and physiologically harmless, so it is also suitable for use in the food and pharmaceutical sectors

PS

- Stands for polystyrene
- Is a widely used, thermoplastic bulk plastic, which is usually obtained by radical polymerisation of styrene

PPR

- Stands for polypropylene regranulate
- Is a product made from recycled plastics (post-consumer or post-industrial waste) and comes from a sustainable circular economy
- The recycled material is obtained from certified sources, resulting in products of consistently high quality
- The regranulate quality is selected according to the customer's requirements

PP

- Stands for polypropylene
- Is a plastic that belongs to the polyolefin group
- Has very high resistance to almost all solvents and greases as well as to most alkalis and acids
- Is supplied as a colourless plastic granulate to which certain additives are added as required
- The tested and approved raw material is odourless, skin-friendly and physiologically harmless, so it is also suitable for use in the food and pharmaceutical sectors
- Is resistant to alkalis
- Is supplied as a colourless plastic granulate to which certain additives are added as required

- The use of regranulate optimises the carbon footprint of the respective end product
- Regranulate generally has a dark colour (iron grey, cf. RAL 7011)
- Due to the manufacturing process of PPR, there may be minimal colour deviations in a batch or in subsequent deliveries

All the plastics named above are recyclable.

Further information about ESD

- **E**lectro **s**tatic **d**ischarge
- These are short-term, transient discharges (unpredictable, non-periodic voltages, currents or charges)
- ESD is often accompanied by a spark or insulation breakdown, which causes a short but high electrical current pulse
- The cause of the potential difference is usually an electric charge due to friction
- ESD can damage electronic components and systems
- The duration of a discharge ranges from nanoseconds to milliseconds
- The discharge potentials reach several kilovolts (KV) or even megavolts (MV)



Differences between PPL 3 and PPL 6 materials

Electrically conductive material (PPL 3)

- The specific surface resistance of the material is conductive (electrostatically conductive)
- Used in accordance with the EN 61 340 standards
- For containers that *do not come* into direct contact with sensitive components
- Specific surface resistance: $\geq 1 \times 10^2 \Omega$ and $< 1 \times 10^5 \Omega$

Electrically dissipative material (PPL 6)

- The specific surface resistance of the material is electrostatically dissipative
- Used in accordance with the EN 61 340 standards
- For containers that *come into direct contact* with sensitive electronic components
- Specific surface resistance: $\geq 1 \times 10^5 \Omega$ and $< 1 \times 10^{11} \Omega$

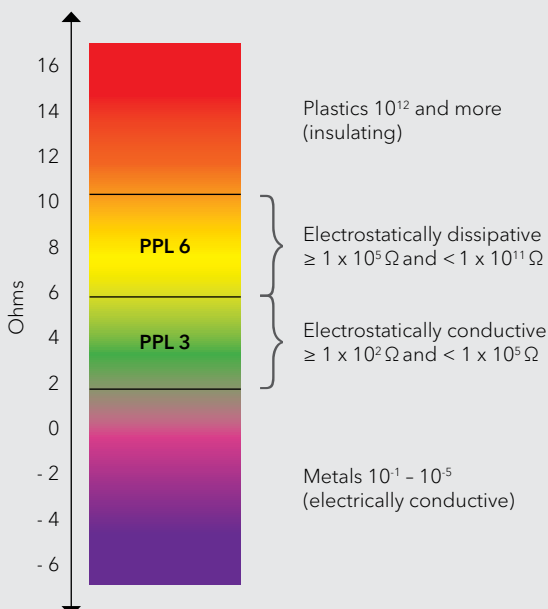

Surface resistance

- The addition of a conductive filler in sufficient concentration produces a conductive polymer material
- Soot is the most common filler

Container identification options

We offer you the following individual marking options ex works:



Hot stamping*

Coloured, durable hot stamping using **standard lettering**. Typical application: company name, department/section, purpose (complaint, quarantined parts, returns). Or coloured, durable hot stamping using an **embossing stamp**. Typical application: company logo



Injection/compression moulding*

Marking is in the same colour as the container, part of the surface is raised. This is done using a customised tool insert. Typical application: company logo



Barcode*

Expertly applied, reliable and cost-effective barcodes on the container according to customer specifications and individual barcode specifications. Depending on the quantity, this is done manually, by robot or by an in-mould process.



RFID*

At the customer's request, we can attach RFID smart labels and/or, following a technical feasibility check, various RFID transponders to the container.



Additive technologies*

As an extension to the barcode for paperless, mobile 24/7 provision of required information via smartphone.

* Minimum order quantities and surcharges on request



Industry solutions for the automotive industry

Containers for storing small parts

Space-saving containers

Containers for semi- and fully automated systems

Storage & transport containers for manual handling

Our expertise: Plastic containers

BB

Storage & transport containers for manual handling

- ELB basic range from page **B2**
- LTF basic range from page **B10**
- LTB basic range from page **B16**
- EF basic range from page **B30**
- MF basic range from page **B58**
- Dividers from page **B68**
- Insert boxes from page **B72**

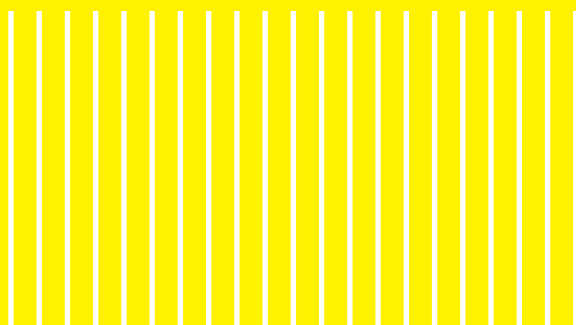

ELB - for light applications

The ELB range, our latest storage and transport container range, is the result of our considerable experience. And this has paid off, because our ELB meets the needs of many industrial customers for containers for simple, manual handling, with a contemporary design and at an attractive price.

The main feature of our ELB range is the very low container weight. This makes the container very easy for people to handle. We also achieve good load capacities thanks to the smart design throughout and top this with a very good value for money.

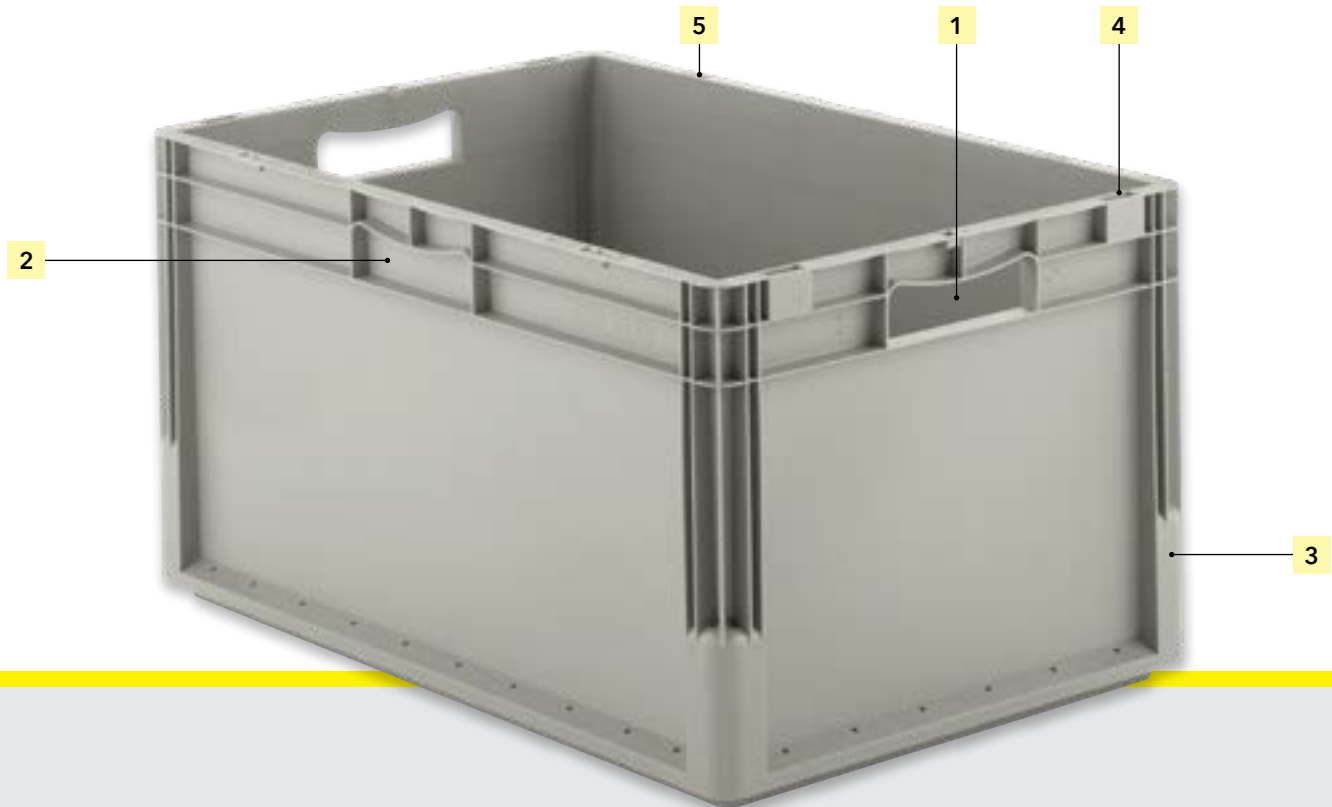

1| Comfortable, ergonomic hand hole* on both short sides for manual handling



2| Closed grip* on both long sides as an additional grip



4| Lifting slots for handling devices



5| Slot for lid hinge



3| Strong corner design thanks to the combination of columns and ribs

* except for height 120 mm



Key facts

- Featherweight containers
- Available immediately from stock with smooth base (20 kg)
- Perfect for easy manual handling
- Ergonomically shaped grips
- Modern design
- Very good value for money

Typical customer applications

- Loads from 10 to 25 kg
- As storage containers
- As transport containers
- For frequent manual handling
- In shelving systems

Smooth standard base
(max. load 20 kg)



Ribbed base VB01
(max. load 35 kg)



Reinforced welded base VS01
(max. load 50 kg)



Standard colour:



Standard models

400 x 300 x 120 mm



ELB 4120 PP

External dimensions L x W x H	399 x 299 x 120 mm
-------------------------------	--------------------

Internal dimensions L x W x H	356 x 256 x 115 mm
-------------------------------	--------------------

Usable height when stacked	100 mm
----------------------------	--------

Capacity	10.9 litres
----------	-------------

Load (max.)	20 kg
-------------	-------

Colour	Grey
--------	------

Order no.	56505
-----------	-------

ELB 4120 VB01 PP with ribbed base

Internal dimensions L x W x H	359 x 259 x 103 mm
-------------------------------	--------------------

Usable height when stacked	89 mm
----------------------------	-------

Capacity	9.9 litres
----------	------------

Load (max.)	35 kg
-------------	-------

Colour	Grey
--------	------

Order no.	56515*
-----------	--------

ELB 4120 VS01 PP with reinforced welded base

Internal dimensions L x W x H	356 x 259 x 103 mm
-------------------------------	--------------------

Usable height when stacked	89 mm
----------------------------	-------

Load (max.)	50 kg
-------------	-------

Colour	Grey
--------	------

Order no.	56525*
-----------	--------

400 x 300 x 220 mm



ELB 4220 PP

External dimensions L x W x H	399 x 299 x 220 mm
-------------------------------	--------------------

Internal dimensions L x W x H	356 x 256 x 215 mm
-------------------------------	--------------------

Usable height when stacked	200 mm
----------------------------	--------

Capacity	20.4 litres
----------	-------------

Load (max.)	20 kg
-------------	-------

Colour	Grey
--------	------

Order no.	56535
-----------	-------

ELB 4220 VB01 PP with ribbed base

Internal dimensions L x W x H	359 x 259 x 203 mm
-------------------------------	--------------------

Usable height when stacked	188 mm
----------------------------	--------

Capacity	19.5 litres
----------	-------------

Load (max.)	35 kg
-------------	-------

Colour	Grey
--------	------

Order no.	56545*
-----------	--------

ELB 4220 VS01 PP with reinforced welded base

Internal dimensions L x W x H	359 x 258 x 203 mm
-------------------------------	--------------------

Usable height when stacked	188 mm
----------------------------	--------

Load (max.)	50 kg
-------------	-------

Colour	Grey
--------	------

Order no.	56555*
-----------	--------

ELB 6120 PP

External dimensions L x W x H	599 x 399 x 120 mm
Internal dimensions L x W x H	555 x 355 x 115 mm
Usable height when stacked	100 mm
Capacity	23.3 litres
Load (max.)	20 kg
Colour	Grey
Order no.	56565

ELB 6120 VB01 PP with ribbed base

Internal dimensions L x W x H	560 x 360 x 103 mm
Usable height when stacked	89 mm
Capacity	21.2 litres
Load (max.)	35 kg
Colour	Grey
Order no.	56575*

ELB 6120 VS01 PP with reinforced welded base

Internal dimensions L x W x H	560 x 360 x 103 mm
Usable height when stacked	89 mm
Load (max.)	50 kg
Colour	Grey
Order no.	56585*

600 x 400 x 120 mm

**ELB 6220 PP**

External dimensions L x W x H	599 x 399 x 220 mm
Internal dimensions L x W x H	555 x 355 x 215 mm
Usable height when stacked	200 mm
Capacity	43.7 litres
Load (max.)	20 kg
Colour	Grey
Order no.	56595

ELB 6220 VB01 PP with ribbed base

Internal dimensions L x W x H	560 x 360 x 203 mm
Usable height when stacked	188 mm
Capacity	41.7 litres
Load (max.)	35 kg
Colour	Grey
Order no.	56605*

ELB 6220 VS01 PP with reinforced welded base

Internal dimensions L x W x H	560 x 360 x 203 mm
Usable height when stacked	188 mm
Load (max.)	50 kg
Colour	Grey
Order no.	56615*

600 x 400 x 220 mm

**ELB 6320 PP**

External dimensions L x W x H	599 x 399 x 320 mm
Internal dimensions L x W x H	555 x 355 x 314 mm
Usable height when stacked	300 mm
Capacity	64.0 litres
Load (max.)	20 kg
Colour	Grey
Order no.	56625

ELB 6320 VB01 PP with ribbed base

Internal dimensions L x W x H	560 x 360 x 303 mm
Usable height when stacked	288 mm
Capacity	62.3 litres
Load (max.)	35 kg
Colour	Grey
Order no.	56635*

ELB 6320 VS01 PP with reinforced welded base

Internal dimensions L x W x H	560 x 360 x 303 mm
Usable height when stacked	288 mm
Load (max.)	50 kg
Colour	Grey
Order no.	56645*

600 x 400 x 320 mm



With two-part hinged lids

400 x 300 x 137 mm



ELB-DH 4120 PP

External dimensions L x W x H	399 x 299 x 137 mm
Internal dimensions L x W x H	356 x 256 x 115 mm
Usable height when stacked	100 mm
Capacity	10.9 litres
Load (max.)	20 kg
Colour	Grey
Order no.	56005

ELB-DH 4120 VB01 PP with ribbed base

Internal dimensions L x W x H	359 x 259 x 103 mm
Usable height when stacked	89 mm
Capacity	9.9 litres
Load (max.)	35 kg
Colour	Grey
Order no.	56905*

ELB-DH 4120 VS01 PP with reinforced welded base

Internal dimensions L x W x H	356 x 259 x 103 mm
Usable height when stacked	89 mm
Load (max.)	50 kg
Colour	Grey
Order no.	56055*

400 x 300 x 237 mm



ELB-DH 4220 PP

External dimensions L x W x H	399 x 299 x 237 mm
Internal dimensions L x W x H	356 x 256 x 215 mm
Usable height when stacked	200 mm
Capacity	20.4 litres
Load (max.)	20 kg
Colour	Grey
Order no.	56015

ELB-DH 4220 VB01 PP with ribbed base

Internal dimensions L x W x H	359 x 259 x 203 mm
Usable height when stacked	188 mm
Capacity	19.5 litres
Load (max.)	35 kg
Colour	Grey
Order no.	56915*

ELB-DH 4220 VS01 PP with reinforced welded base

Internal dimensions L x W x H	359 x 258 x 203 mm
Usable height when stacked	188 mm
Load (max.)	50 kg
Colour	Grey
Order no.	56065*

ELB-DH 6120 PP

External dimensions L x W x H	599 x 399 x 137 mm
Internal dimensions L x W x H	555 x 355 x 115 mm
Usable height when stacked	100 mm
Capacity	23.3 litres
Load (max.)	20 kg
Colour	Grey
Order no.	56025*

ELB-DH 6120 VB01 PP with ribbed base

Internal dimensions L x W x H	560 x 360 x 103 mm
Usable height when stacked	89 mm
Capacity	21.2 litres
Load (max.)	35 kg
Colour	Grey
Order no.	56925*

ELB-DH 6120 VS01 PP with reinforced welded base

Internal dimensions L x W x H	560 x 360 x 103 mm
Usable height when stacked	89 mm
Load (max.)	50 kg
Colour	Grey
Order no.	56075*

600 x 400 x 137 mm

**ELB-DH 6220 PP**

External dimensions L x W x H	599 x 399 x 237 mm
Internal dimensions L x W x H	555 x 355 x 215 mm
Usable height when stacked	200 mm
Capacity	43.7 litres
Load (max.)	20 kg
Colour	Grey
Order no.	56035

ELB-DH 6220 VB01 PP with ribbed base

Internal dimensions L x W x H	560 x 360 x 203 mm
Usable height when stacked	188 mm
Capacity	41.7 litres
Load (max.)	35 kg
Colour	Grey
Order no.	56935*

ELB-DH 6220 VS01 PP with reinforced welded base

Internal dimensions L x W x H	560 x 360 x 203 mm
Usable height when stacked	188 mm
Load (max.)	50 kg
Colour	Grey
Order no.	56085*

600 x 400 x 237 mm

**ELB-DH 6320 PP**

External dimensions L x W x H	599 x 399 x 337 mm
Internal dimensions L x W x H	555 x 355 x 314 mm
Usable height when stacked	300 mm
Capacity	64.0 litres
Load (max.)	20 kg
Colour	Grey
Order no.	56045

ELB-DH 6320 VB01 PP with ribbed base

Internal dimensions L x W x H	560 x 360 x 303 mm
Usable height when stacked	288 mm
Capacity	62.3 litres
Load (max.)	35 kg
Colour	Grey
Order no.	56945*

ELB-DH 6320 VS01 PP with reinforced welded base

Internal dimensions L x W x H	560 x 360 x 303 mm
Usable height when stacked	288 mm
Load (max.)	50 kg
Colour	Grey
Order no.	56095*

600 x 400 x 337 mm



Lids and pallet covers

Basic dimensions 400 x 300 mm



LTB-D 43 PP drop-on lid

Colour	Grey
Order no.	75905

LTB-D 43 S PP with hinges*

Colour	Grey
Order no.	76205

* including two lid hinges (lid clips available on request)

Basic dimensions 600 x 400 mm



LTB-D 64 PP drop-on lid

Colour	Grey
Order no.	75915

LTB-D 64 S PP with hinges*

Colour	Grey
Order no.	76215

* including two lid hinges (lid clips available on request)

Lid clips

Colour	White
Order no.	99237



Drop-on lid



Lid with hinges



Lid clip (on request)

Basic dimensions 800 x 600 mm



ADH 86 PP pallet cover with banding slots and indentations for dollies

External dimensions L x W x H	814 x 614 x 44 mm
Height when stacked	30 mm
Colour	Black
Order no.	93628

Pallet covers and accessories

A 1208 PP pallet cover

Colour	Blue
Order no.	39704

A 1208-1 PP pallet cover

Colour	Blue
Order no.	35614

Basic dimensions 1200 x 800 mm

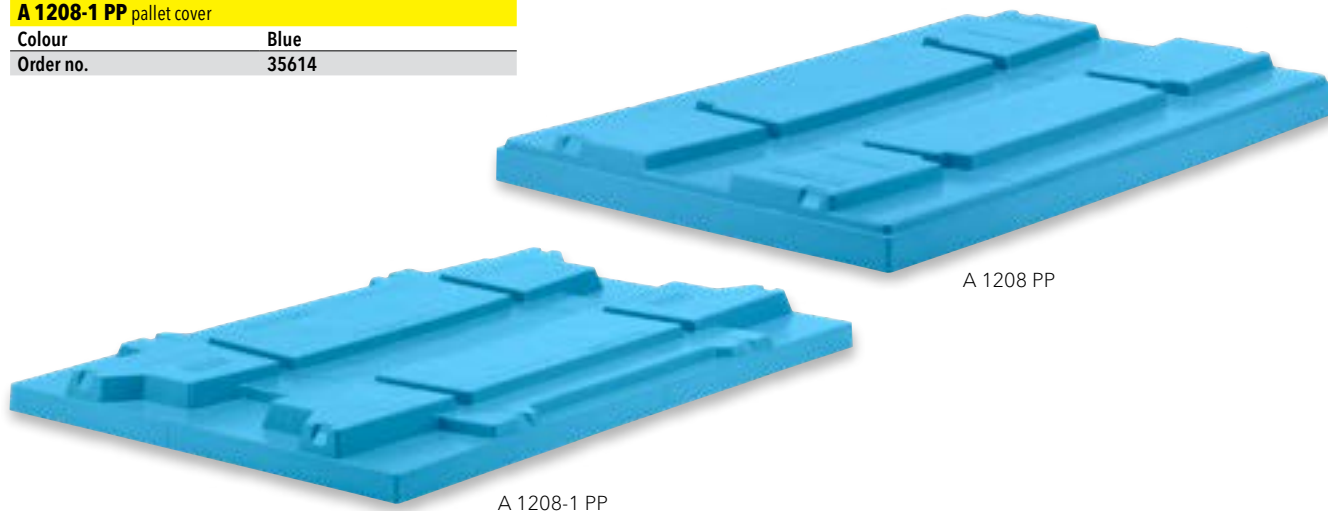

GV-MF PP

Packaging unit	1 unit	
Colour	Blue	Grey
Order no.	39794	39795

Grip closure



ELB-E

Packaging unit	1 unit
Order no.	16020

Label holder

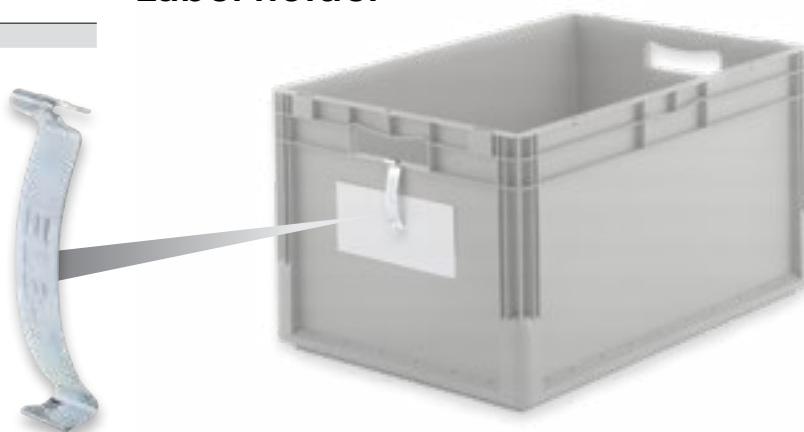

LTF - for medium-duty manual applications

The LTF range was developed with the aim of offering a solid, cost-effective container solution for loads in the medium weight range.

Particularly noteworthy is the running frame base. This base offers a combination of a smooth base and a ribbed base. Here we combine the load-bearing advantages of a reinforced ribbed base with the advantages of a smooth

peripheral rim. In manual handling, this has a positive impact on ergonomics and noise levels when, for example, pushing or pulling, or when conveyor lines or ball tables are used. The sturdy corner column design makes the LTF a solid, durable and very economical container option.



1| Ergonomic open grip*
on both short sides



2| Closed grip*
on both long sides



3| Strong corner design thanks to the column construction, with alignment holes



4| Lifting slots
for handling devices



5| Label holders on long and short sides,
in case of height 120 mm only on the
short sides

* except for height 120 mm



Key facts

- Efficient all-rounder for your internal and external material flows
- Strong corner column design
- Advantageous running frame base
- Immediately available from stock with running frame base (30 kg)
- Ergonomically shaped grips
- Long service life and high cost-effectiveness

Typical customer applications

- Loads from 30 to 50 kg
- As storage containers
- As transport containers
- Compatible with handling devices
- Suitable as a solid entry-level model for later automation (see page C10)
- As a temporary "low-budget" storage solution
LTF 6320 B01: with end-wall opening, small parts storage in the container stack, picking possible out of each container (see page B14)

Standard base
(max. load 30 kg)

Reinforced, diagonally ribbed base VB02
(max. load 50 kg)

Reinforced welded base VS01
(max. load 70 kg)



Standard colours:



Bases optionally with water drainage holes in accordance with VDS guideline for categorisation in HHS 3.

Standard models

600 x 400 x 120 mm



LTF 6120 PP

External dimensions L x W x H	594 x 396 x 120 mm	
Internal dimensions L x W x H	564 x 366 x 102 mm	
Usable height when stacked	87 mm	
Capacity	21.0 litres	
Load (max.)	30 kg	
Colour	Blue	Grey
Order no.	35764	35765

LTF 6120 VB02 PP with ribbed base

Internal dimensions L x W x H	564 x 366 x 102 mm	
Usable height when stacked	87 mm	
Capacity	21.0 litres	
Load (max.)	50 kg	
Colour	Blue	Grey
Order no.	86094*	86095*

LTF 6120 VS01 PP with reinforced welded base

Internal dimensions L x W x H	564 x 366 x 102 mm	
Usable height when stacked	87 mm	
Capacity	21.0 litres	
Load (max.)	70 kg	
Colour	Blue	Grey
Order no.	86104*	86105*

600 x 400 x 220 mm



LTF 6220 PP

External dimensions L x W x H	594 x 396 x 220 mm	
Internal dimensions L x W x H	564 x 366 x 202 mm	
Usable height when stacked	187 mm	
Capacity	42.0 litres	
Load (max.)	30 kg	
Colour	Blue	Grey
Order no.	35724	35725

LTF 6220 VB02 PP with ribbed base

Internal dimensions L x W x H	564 x 366 x 202 mm	
Usable height when stacked	187 mm	
Capacity	42.0 litres	
Load (max.)	50 kg	
Colour	Blue	Grey
Order no.	86124*	86125*

LTF 6220 VS01 PP with reinforced welded base

Internal dimensions L x W x H	564 x 366 x 202 mm	
Usable height when stacked	187 mm	
Capacity	42.0 litres	
Load (max.)	70 kg	
Colour	Blue	Grey
Order no.	86134*	86135*

LTF 6280 PP

External dimensions L x W x H	594 x 396 x 280 mm	
Internal dimensions L x W x H	564 x 366 x 262 mm	
Usable height when stacked	247 mm	
Capacity	53.8 litres	
Load (max.)	30 kg	
Colour	Blue	Grey
Order no.	35704	35705

LTF 6280 VB02 PP with ribbed base

Internal dimensions L x W x H	564 x 366 x 262 mm	
Usable height when stacked	247 mm	
Capacity	53.8 litres	
Load (max.)	50 kg	
Colour	Blue	Grey
Order no.	86154*	86155*

LTF 6280 VS01 PP with reinforced welded base

Internal dimensions L x W x H	564 x 366 x 262 mm	
Usable height when stacked	247 mm	
Capacity	53.8 litres	
Load (max.)	70 kg	
Colour	Blue	Grey
Order no.	86164*	86165*

600 x 400 x 280 mm

**LTF 6320 PP**

External dimensions L x W x H	594 x 396 x 320 mm	
Internal dimensions L x W x H	564 x 366 x 302 mm	
Usable height when stacked	287 mm	
Capacity	62.7 litres	
Load (max.)	30 kg	
Colour	Blue	Grey
Order no.	35734	35735

LTF 6320 VB02 PP with ribbed base

Internal dimensions L x W x H	564 x 366 x 302 mm	
Usable height when stacked	287 mm	
Capacity	62.7 litres	
Load (max.)	50 kg	
Colour	Blue	Grey
Order no.	86184*	86185*

LTF 6320 VS01 PP with reinforced welded base

Internal dimensions L x W x H	564 x 366 x 302 mm	
Usable height when stacked	287 mm	
Capacity	62.7 litres	
Load (max.)	70 kg	
Colour	Blue	Grey
Order no.	86194*	86195*

600 x 400 x 320 mm



Special LTF container and lid

600 x 400 x 320 mm



LTF 6320 B01 PP one short side 1/2 open		
External dimensions L x W x H	594 x 396 x 320 mm	
Internal dimensions L x W x H	564 x 366 x 302 mm	
Usable height when stacked	287 mm	
Short side opening W x H	275 x 140 mm	
Capacity	62.7 litres	
Load (max.)	30 kg	
Colour	Blue	Grey
Order no.	35694*	35695*
SK 64152-1 PP dust flap		
Colour	Translucent	
Order no.	93922*	

Tip: Our customers use our LTF 6320 B01 with a dust flap when bottlenecks occur or as temporary flexible storage. If the containers are stacked on top of each other, picking possible out of each container

Basic dimensions 600 x 400 mm

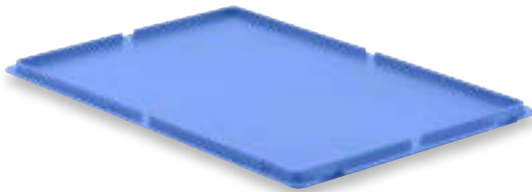

MF-D 64 PP drop-on lid with banding slots on all sides		
Colour	Blue	Grey
Order no.	39744	39745
MF-D 64-H PP with hooks**		
Colour	Blue	Grey
Order no.	39754	39755
MF-D 64-S PP with hinges		
Colour	Blue	Grey
Order no.	39874	39875
MF-D 64-SF PP factory-fitted lid		
Colour	Blue	Grey
Order no.	39764*	39765*

** Lid clips available on request

Lid clips	
Colour	White
Order no.	99227



Lid with hooks



Hinged lid with reinforcing ring, assembled



Lid clip (on request)

Pallet covers and accessories

A 1208 PP pallet cover

Colour	Blue
Order no.	39704

A 1208-1 PP pallet cover

Colour	Blue
Order no.	35614

Basic dimensions 1200 x 800 mm

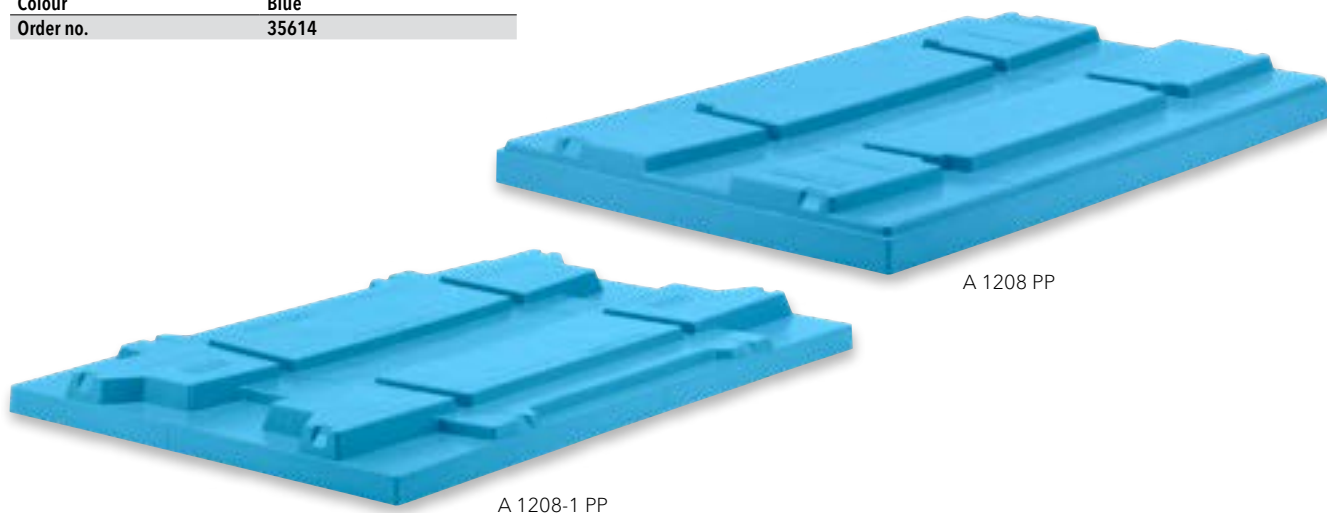

GV-MF PP

Packaging unit	1 unit	
Colour	Blue	Grey
Order no.	39794	39795

GV-MF 3 PP smooth model

Packaging unit	1 unit	
Colour	Blue	Grey
Order no.	22374	22385

Other colours on request

Grip closure

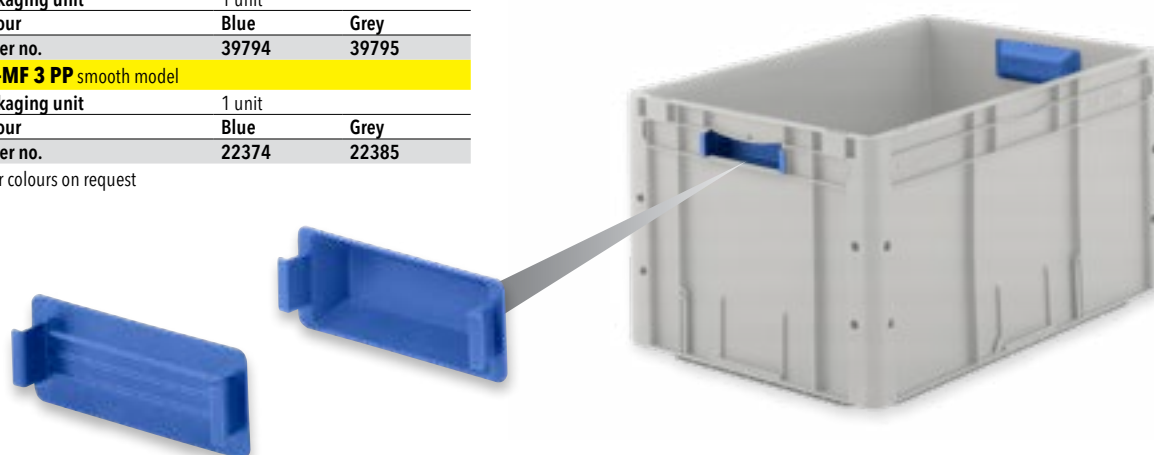

LTF-E

Packaging unit	1 unit
Order no.	16020

Label holder



LTB - for heavy manual applications

Our LTB was designed for heavy loads and the related forces that act on a container during storage and transport. This is why our LTB also has the highest stacking load capacity, both static and dynamic.

Our customers particularly appreciate the long service life and stability. LTB stands for reliability 24/7 in tough industrial use.

This is the container you need for challenging industrial applications involving the storage and/or transport of heavy products/contents.

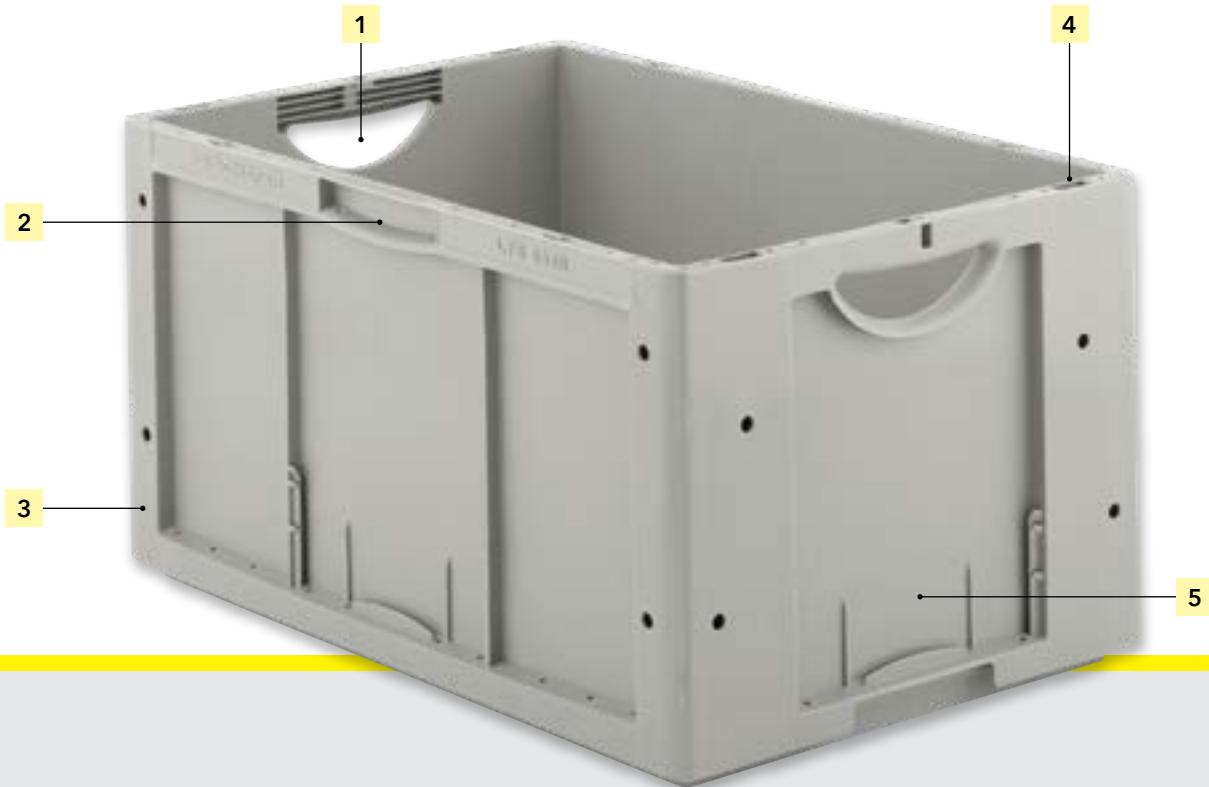

1| Ergonomic open grip*
on both short sides



2| Closed underbarrel handle*
on both long sides



3| Strong corner design
thanks to column construction,
with alignment holes



4| Lifting slots
for handling devices



5| Label holders on long and short sides
for accompanying documents

* except for height 120 mm



Key facts

- Container for heavy loads
- Maximum stacking load, both static and dynamic
- Particularly easy-to-grasp ergonomic grips
- Available immediately from stock with ribbed base (50 kg)
- Designed for use by handling devices
- Long service life and high cost-effectiveness

Typical customer applications

- Loads from 50 to 70 kg
- Also over 100 kg (please consult our specialist staff for advice)
- As storage containers
- As transport containers
- Compatible with handling devices
- Also suitable for subsequent automation (see page C16)

Smooth standard base GL
(max. load 25 kg)



Reinforced base VB
(max. load 50 kg)



Reinforced welded base VS01/05
(max. load 70 kg)



Standard colours:



Standard models

400 x 300 x 120 mm



LTB 4120 PP with reinforced base

External dimensions L x W x H	399 x 299 x 120 mm	
Internal dimensions L x W x H	367 x 267 x 103 mm	
Usable height when stacked	88 mm	
Capacity	10.0 litres	
Load (max.)	50 kg	
Colour	Blue	Grey
Order no.	75704	75705

LTF 4120 VS01 PP with reinforced welded base

Internal dimensions L x W x H	367 x 267 x 103 mm	
Usable height when stacked	88 mm	
Load (max.)	70 kg	
Colour	Blue	Grey
Order no.	79264*	79265*

400 x 300 x 220 mm



LTB 4220 PP with reinforced base

External dimensions L x W x H	399 x 299 x 220 mm	
Internal dimensions L x W x H	367 x 267 x 203 mm	
Usable height when stacked	188 mm	
Capacity	19.8 litres	
Load (max.)	50 kg	
Colour	Blue	Grey
Order no.	75744	75745

LTB 4220 VS01 PP with reinforced welded base

Internal dimensions L x W x H	367 x 267 x 203 mm	
Usable height when stacked	188 mm	
Load (max.)	70 kg	
Colour	Blue	Grey
Order no.	79284*	79285*

LTB 6120 PP with reinforced base

External dimensions L x W x H 599 x 399 x 120 mm

Internal dimensions L x W x H 567 x 367 x 98 mm

Usable height when stacked 83 mm

Capacity 20.3 litres

Load (max.) 50 kg

Colour **Blue** **Grey**Order no. **75784** **75785****LTB 6120 VS01 PP** with reinforced welded base

Internal dimensions L x W x H 567 x 367 x 98 mm

Usable height when stacked 83 mm

Load (max.) 70 kg

Colour **Blue** **Grey**Order no. **76104*** **76105***

600 x 400 x 120 mm

**LTB 6170 PP** with reinforced base

External dimensions L x W x H 599 x 399 x 170 mm

Internal dimensions L x W x H 567 x 367 x 148 mm

Usable height when stacked 133 mm

Capacity 30.7 litres

Load (max.) 50 kg

Colour **Blue** **Grey**Order no. **75804** **75805****LTB 6170 VS01 PP** with reinforced welded base

Internal dimensions L x W x H 567 x 367 x 148 mm

Usable height when stacked 133 mm

Load (max.) 70 kg

Colour **Blue** **Grey**Order no. **76114*** **76115*****LTB 6170 GL PP** with smooth base

Internal dimensions L x W x H 554 x 354 x 167 mm

Usable height when stacked 152 mm

Capacity 34.5 litres

Load (max.) 25 kg

Colour **Blue** **Grey**Order no. **86054*** **86055***

600 x 400 x 170 mm

**LTB 6220 PP** with reinforced base

External dimensions L x W x H 599 x 399 x 220 mm

Internal dimensions L x W x H 567 x 367 x 198 mm

Usable height when stacked 183 mm

Capacity 41.0 litres

Load (max.) 50 kg

Colour **Blue** **Grey**Order no. **75824** **75825****LTB 6220 VS01 PP** with reinforced welded base

Internal dimensions L x W x H 567 x 367 x 198 mm

Usable height when stacked 183 mm

Load (max.) 70 kg

Colour **Blue** **Grey**Order no. **76124*** **76125*****LTB 6220 GL PP** with smooth base

Internal dimensions L x W x H 554 x 354 x 217 mm

Usable height when stacked 202 mm

Capacity 42.3 litres

Load (max.) 25 kg

Colour **Blue** **Grey**Order no. **79304*** **79305***

600 x 400 x 220 mm



Standard models

600 x 400 x 270 mm



LTB 6270 PP with reinforced base		
External dimensions L x W x H	599 x 399 x 270 mm	
Internal dimensions L x W x H	567 x 367 x 248 mm	
Usable height when stacked	233 mm	
Capacity	51.4 litres	
Load (max.)	50 kg	
Colour	Blue	Grey
Order no.	75844	75845

LTB 6270 VS01 PP with reinforced welded base		
Internal dimensions L x W x H	567 x 367 x 248 mm	
Usable height when stacked	233 mm	
Load (max.)	70 kg	
Colour	Blue	Grey
Order no.	76134*	76135*

600 x 400 x 320 mm



LTB 6320 PP with reinforced base		
External dimensions L x W x H	599 x 399 x 320 mm	
Internal dimensions L x W x H	567 x 367 x 298 mm	
Usable height when stacked	283 mm	
Capacity	61.7 litres	
Load (max.)	50 kg	
Colour	Blue	Grey
Order no.	75864	75865

LTB 6320 VS01 PP with reinforced welded base		
Internal dimensions L x W x H	567 x 367 x 298 mm	
Usable height when stacked	283 mm	
Load (max.)	70 kg	
Colour	Blue	Grey
Order no.	76144*	76145*

600 x 400 x 420 mm



LTB 6420 PP with reinforced base		
External dimensions L x W x H	599 x 399 x 420 mm	
Internal dimensions L x W x H	567 x 367 x 398 mm	
Usable height when stacked	383 mm	
Capacity	82.3 litres	
Load (max.)	50 kg	
Colour	Blue	Grey
Order no.	86064	86065

LTB 6420 VS01 PP with reinforced welded base		
Internal dimensions L x W x H	567 x 367 x 398 mm	
Usable height when stacked	383 mm	
Load (max.)	70 kg	
Colour	Blue	Grey
Order no.	86074*	86075*

LTB 8220 GL PP with smooth base

External dimensions L x W x H 799 x 599 x 220 mm

Internal dimensions L x W x H 752 x 552 x 217 mm

Usable height when stacked 197 mm

Capacity 91.8 litres

Load (max.) 25 kg

Colour **Blue** **Grey**

Order no. **76014*** **76015***

LTB 8220 VS05 PP with reinforced welded base

Internal dimensions L x W x H 755 x 555 x 197 mm

Usable height when stacked 177 mm

Capacity 84.5 litres

Load (max.) 70 kg

Colour **Blue** **Grey**

Order no. **76024*** **76025***

800 x 600 x 220 mm



LTB 8320 GL PP with smooth base

External dimensions L x W x H 799 x 599 x 320 mm

Internal dimensions L x W x H 752 x 552 x 317 mm

Usable height when stacked 297 mm

Capacity 135.0 litres

Load (max.) 25 kg

Colour **Blue** **Grey**

Order no. **76244** **76245**

LTB 8320 VS05 PP with reinforced welded base

Internal dimensions L x W x H 755 x 555 x 297 mm

Usable height when stacked 277 mm

Capacity 125.0 litres

Load (max.) 70 kg

Colour **Blue** **Grey**

Order no. **76284*** **76285***

800 x 600 x 320 mm



LTB 8420 GL PP with smooth base

External dimensions L x W x H 799 x 599 x 420 mm

Internal dimensions L x W x H 752 x 552 x 417 mm

Usable height when stacked 397 mm

Capacity 175.0 litres

Load (max.) 25 kg

Colour **Blue** **Grey**

Order no. **76264*** **76265***

LTB 8420 VS05 PP with reinforced welded base

Internal dimensions L x W x H 755 x 555 x 397 mm

Usable height when stacked 377 mm

Capacity 165.0 litres

Load (max.) 70 kg

Colour **Blue** **Grey**

Order no. **76294*** **76295***

800 x 600 x 420 mm



With two-part hinged lids

400 x 300 x 137 mm

LTB-DH 4120 PP with reinforced base

External dimensions L x W x H 399 x 299 x 137 mm

Internal dimensions L x W x H 367 x 267 x 103 mm

Usable height when stacked 88 mm

Capacity 10.0 litres

Load (max.) 50 kg

 Colour **Blue** **Grey**

 Order no. **75714*** **75715***
LTB-DH 4120 VS01 PP with reinforced welded base

Internal dimensions L x W x H 367 x 267 x 103 mm

Usable height when stacked 88 mm

Load (max.) 70 kg

 Colour **Blue** **Grey**

 Order no. **79274*** **79275***

400 x 300 x 237 mm

LTB-DH 4220 PP with reinforced base

External dimensions L x W x H 399 x 299 x 237 mm

Internal dimensions L x W x H 367 x 267 x 203 mm

Usable height when stacked 188 mm

Capacity 19.8 litres

Load (max.) 50 kg

 Colour **Blue** **Grey**

 Order no. **75754*** **75755***
LTB-DH 4220 VS01 PP with reinforced welded base

Internal dimensions L x W x H 367 x 267 x 203 mm

Usable height when stacked 188 mm

Load (max.) 70 kg

 Colour **Blue** **Grey**

 Order no. **79294*** **79295***

LTB-DH 6120 PP with reinforced base

External dimensions L x W x H 599 x 399 x 137 mm

Internal dimensions L x W x H 567 x 367 x 98 mm

Usable height when stacked 83 mm

Capacity 20.3 litres

Load (max.) 50 kg

Colour **Blue** **Grey**Order no. **75794*** **75795*****LTB-DH 6120 VS01 PP** with reinforced welded base

Internal dimensions L x W x H 567 x 367 x 98 mm

Usable height when stacked 83 mm

Load (max.) 70 kg

Colour **Blue** **Grey**Order no. **76154*** **76155***

600 x 400 x 137 mm

**LTB-DH 6170 PP** with reinforced base

External dimensions L x W x H 599 x 399 x 187 mm

Internal dimensions L x W x H 567 x 367 x 148 mm

Usable height when stacked 133 mm

Capacity 30.7 litres

Load (max.) 50 kg

Colour **Blue** **Grey**Order no. **75814*** **75815*****LTB-DH 6170 VS01 PP** with reinforced welded base

Internal dimensions L x W x H 567 x 367 x 148 mm

Usable height when stacked 133 mm

Load (max.) 70 kg

Colour **Blue** **Grey**Order no. **76164*** **76165*****LTB-DH 6170 GL PP** with smooth base

Internal dimensions L x W x H 554 x 354 x 167 mm

Usable height when stacked 152 mm

Capacity 34.5 litres

Load (max.) 25 kg

Colour **Blue** **Grey**Order no. **86224*** **86225***

600 x 400 x 187 mm

**LTB-DH 6220 PP** with reinforced base

External dimensions L x W x H 599 x 399 x 237 mm

Internal dimensions L x W x H 567 x 367 x 198 mm

Usable height when stacked 183 mm

Capacity 41.0 litres

Load (max.) 50 kg

Colour **Blue** **Grey**Order no. **75834*** **75835*****LTB-DH 6220 VS01 PP** with reinforced welded base

Internal dimensions L x W x H 567 x 367 x 198 mm

Usable height when stacked 183 mm

Load (max.) 70 kg

Colour **Blue** **Grey**Order no. **76174*** **76175*****LTB-DH 6220 GL PP** with smooth base

Internal dimensions L x W x H 554 x 354 x 217 mm

Usable height when stacked 202 mm

Capacity 42.3 litres

Load (max.) 25 kg

Colour **Blue** **Grey**Order no. **79314*** **79315***

600 x 400 x 237 mm



With two-part hinged lids

600 x 400 x 287 mm



LTB-DH 6270 PP with reinforced base

External dimensions L x W x H	599 x 399 x 287 mm	
Internal dimensions L x W x H	567 x 367 x 248 mm	
Usable height when stacked	233 mm	
Capacity	51.4 litres	
Load (max.)	50 kg	
Colour	Blue	Grey
Order no.	75854*	75855*

LTB-DH 6270 VS01 PP with reinforced welded base

Internal dimensions L x W x H	567 x 367 x 248 mm	
Usable height when stacked	233 mm	
Load (max.)	70 kg	
Colour	Blue	Grey
Order no.	76184*	76185*

600 x 400 x 337 mm



LTB-DH 6320 PP with reinforced base

External dimensions L x W x H	599 x 399 x 337 mm	
Internal dimensions L x W x H	567 x 367 x 298 mm	
Usable height when stacked	283 mm	
Capacity	61.7 litres	
Load (max.)	50 kg	
Colour	Blue	Grey
Order no.	75874*	75875*

LTB-DH 6320 VS01 PP with reinforced welded base

Internal dimensions L x W x H	567 x 367 x 298 mm	
Usable height when stacked	283 mm	
Load (max.)	70 kg	
Colour	Blue	Grey
Order no.	76194*	76195*

600 x 400 x 437 mm



LTB-DH 6420 PP with reinforced base

External dimensions L x W x H	599 x 399 x 437 mm	
Internal dimensions L x W x H	567 x 367 x 398 mm	
Usable height when stacked	383 mm	
Capacity	82.3 litres	
Load (max.)	50 kg	
Colour	Blue	Grey
Order no.	86204*	86205*

LTB-DH 6420 VS01 PP with reinforced welded base

Internal dimensions L x W x H	567 x 367 x 398 mm	
Usable height when stacked	383 mm	
Load (max.)	70 kg	
Colour	Blue	Grey
Order no.	86214*	86215*

With skids

LTB 8220 VS05 KU600 PP

External dimensions L x W x H	799 x 599 x 320 mm	
Internal dimensions L x W x H	755 x 555 x 197 mm	
Usable height when stacked	177 mm	
Capacity	84.5 litres	
Fork clearance	100 mm	
Load (max.)	200 kg	
Live load (max.)	750 kg	
Colour	Blue	Grey
Order no.	76044*	76035*

800 x 600 x 320 mm

**LTB 8320 VS05 KU600 PP**

External dimensions L x W x H	799 x 599 x 420 mm	
Internal dimensions L x W x H	755 x 555 x 297 mm	
Usable height when stacked	277 mm	
Capacity	125.0 litres	
Fork clearance	100 mm	
Load (max.)	200 kg	
Live load (max.)	750 kg	
Colour	Blue	Grey
Order no.	762804*	762805*

800 x 600 x 420 mm

**LTB 8420 VS05 KU600 PP**

External dimensions L x W x H	799 x 599 x 520 mm	
Internal dimensions L x W x H	755 x 555 x 397 mm	
Usable height when stacked	377 mm	
Capacity	165.0 litres	
Fork clearance	100 mm	
Load (max.)	200 kg	
Live load (max.)	750 kg	
Colour	Blue	Grey
Order no.	762904*	762905*

800 x 600 x 520 mm



With castors

800 x 600 x 375 mm



LTB 8220 VS05-RL125 PP

External dimensions L x W x H	799 x 599 x 375 mm	
Internal dimensions L x W x H	755 x 555 x 197 mm	
Capacity	84.5 litres	
Fork clearance	125 mm	
Colour	Blue	Grey
Order no.	76044*	76045*

800 x 600 x 475 mm



LTB 8320 VS05-RL125 PP

External dimensions L x W x H	799 x 599 x 475 mm	
Internal dimensions L x W x H	755 x 555 x 297 mm	
Capacity	125.0 litres	
Fork clearance	125 mm	
Colour	Blue	Grey
Order no.	76304*	76305*

800 x 600 x 575 mm



LTB 8420 VS05 RO PP

External dimensions L x W x H	799 x 599 x 575 mm	
Internal dimensions L x W x H	755 x 555 x 397 mm	
Capacity	165.0 litres	
Fork clearance	125 mm	
Colour	Blue	Grey
Order no.	76314*	76315*

Lids

LTB-D 43 PP drop-on lid

Colour	Blue	Grey
Order no.	75904	75905

LTB-D 43 S PP with hinges**

Colour	Blue	Grey
Order no.	76204	76205

** including two lid hinges (lid clips available on request)

Basic dimensions 400 x 300 mm



LTB-D 64 PP drop-on lid

Colour	Blue	Grey
Order no.	75914	75915

LTB-D 64 S PP with hinges**

Colour	Blue	Grey
Order no.	76214	76215

** including two lid hinges (lid clips available on request)

Basic dimensions 600 x 400 mm



Lid clips

Colour	White
Order no.	99237



Lid clip (on request)



Lid with hinges



Drop-on lid

Pallet covers

Basic dimensions 800 x 600 mm

ADH-T 86 PP deep-drawn pallet cover

Colour Black

Order no. 171600*



A 1208 PP pallet cover

Colour	Blue
Order no.	39704

A 1208-1 PP pallet cover

Colour	Blue
Order no.	35614

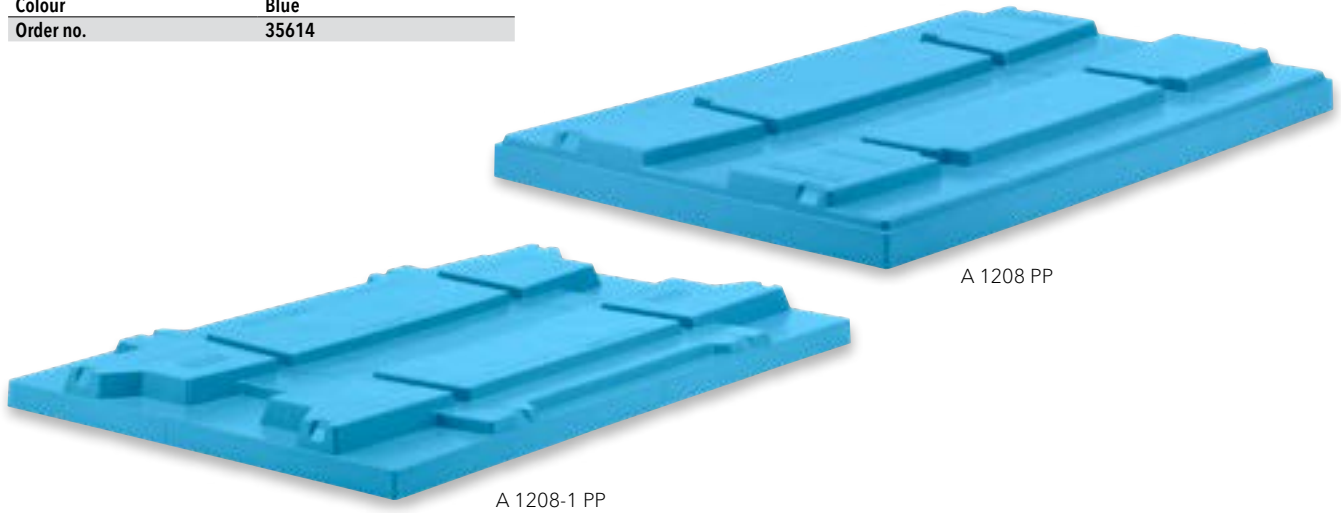
Basic dimensions 1200 x 800 mm

EF - bestseller for decades

The EF container has been the favourite of our regular customers since the 1970s. This range is characterised above all by its versatility: 25 sizes, 150 variants, including several special models. They are all stable in shape, robust and compatible with all other Euro-size containers.

The extensive range of accessories considerably extends the application possibilities.

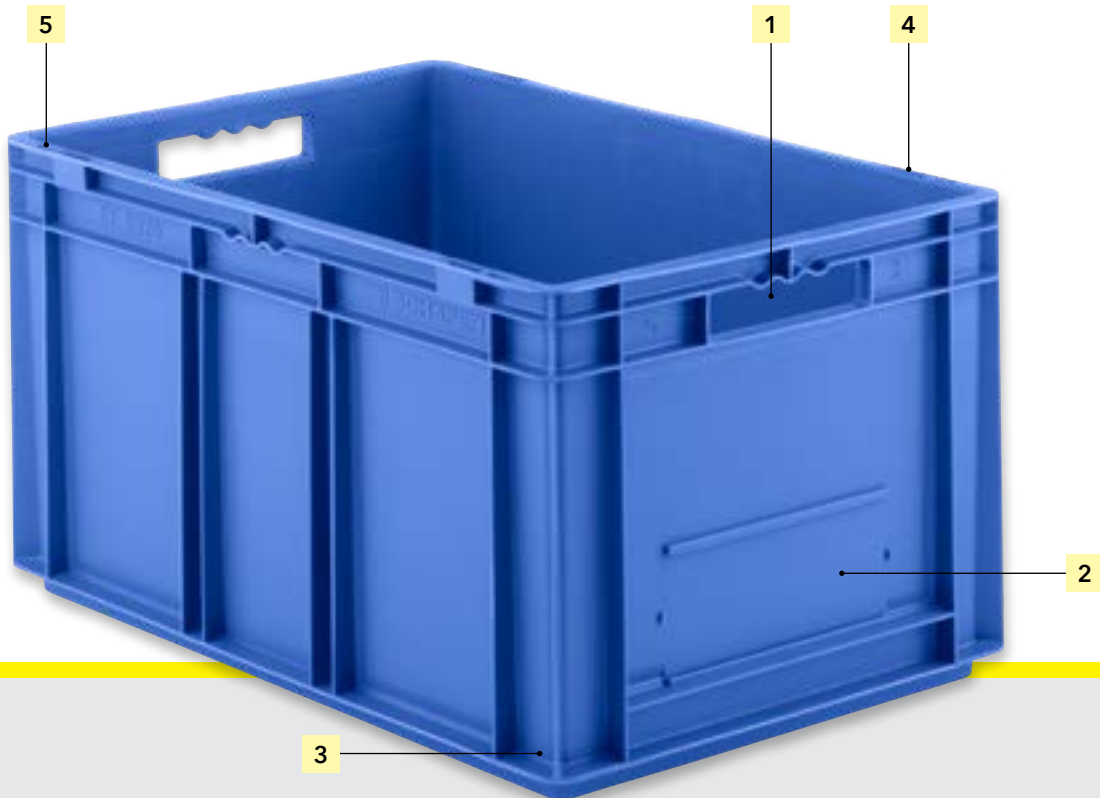

1| Ergonomic open grip* on both short sides, except for heights ≤ 120 mm



2| Label holders
not available for all types



3| Strong corner design
thanks to ribbed construction



4| Lifting slots
for handling devices, EF 6320 only



5| Slot
for lid hinge

* Grip designs may vary (see individual illustrations)



Key facts

- Bestseller among our regular customers since the 1970s.
- Sturdy, robust, durable
- Large choice of special variants (grid base/long sides, pick openings, etc.)

Typical customer applications

- Storage and transport containers
- Range available from stock with a wide variety of dimensions and colours
- Also available in conductive version

Smooth standard base
(max. load 20 kg)



Ribbed base VB
(max. load 50 kg)



Perforated base
(max. load 15 kg)



Standard colours:



Standard models

200 x 150 x 120 mm



EF 2120 PP

External dimensions L x W x H	200 x 148 x 117 mm		
Internal dimensions L x W x H	153 x 106 x 114 mm		
Usable height when stacked	102 mm		
Capacity	2.0 litres		
Load (max.)	10 kg		
Colour	Red	Blue	Grey
Order no.	22031	22034	22035

EF 2120 PPL conductive model

Colour	Black, conductive		
Order no.	22038		

300 x 200 x 120 mm



EF 3120 PP

External dimensions L x W x H	299 x 199 x 117 mm		
Internal dimensions L x W x H	254 x 154 x 114 mm		
Usable height when stacked	102 mm		
Capacity	4.7 litres		
Load (max.)	15 kg		
Colour	Red	Blue	Grey
Order no.	22021	22024	22025

EF 3120 PPL conductive model

Colour	Black, conductive		
Order no.	22028		

300 x 200 x 170 mm



EF 3170 PP

External dimensions L x W x H	299 x 199 x 170 mm		
Internal dimensions L x W x H	253 x 153 x 168 mm		
Usable height when stacked	148 mm		
Capacity	7.0 litres		
Load (max.)	15 kg		
Colour	Red	Blue	Grey
Order no.	22261	22264	22265

EF 3170 PPL conductive model

Colour	Black, conductive		
Order no.	22268		

EF 3220 PP

External dimensions L x W x H	299 x 199 x 220 mm		
Internal dimensions L x W x H	253 x 153 x 217 mm		
Usable height when stacked	197 mm		
Capacity	9.0 litres		
Load (max.)	15 kg		
Colour	Red	Blue	Grey
Order no.	22931	22934	22935

EF 3220 PPL conductive model

Colour	Black, conductive		
Order no.	22938		

300 x 200 x 220 mm

**EF 4040 PP**

External dimensions L x W x H	399 x 299 x 40 mm		
Internal dimensions L x W x H	358 x 258 x 38 mm		
Usable height when stacked	28 mm		
Capacity	3.6 litres		
Load (max.)	15 kg		
Colour	Red	Blue	Grey
Order no.	15501	15504	15505

EF 4040 PPL conductive model

Colour	Black, conductive		
Order no.	15508		

400 x 300 x 40 mm

**EF 4070 PP**

External dimensions L x W x H	399 x 299 x 75 mm		
Internal dimensions L x W x H	359 x 259 x 73 mm		
Usable height when stacked	61 mm		
Capacity	6.9 litres		
Load (max.)	15 kg		
Colour	Red	Blue	Grey
Order no.	21741	21744	21745

EF 4070 PPL conductive model

Colour	Black, conductive		
Order no.	21748		

400 x 300 x 75 mm



Standard models

400 x 300 x 80 mm



EF 4080 PP

External dimensions L x W x H	399 x 299 x 80 mm		
Internal dimensions L x W x H	358 x 258 x 78 mm		
Usable height when stacked	68 mm		
Capacity	7.4 litres		
Load (max.)	15 kg		
Colour	Red	Blue	Grey
Order no.	15511	15514	15515

EF 4080 PPL conductive model

Colour	Black, conductive		
Order no.	15518		

400 x 300 x 81 mm



EFR 4070 PP extension frame

External dimensions L x W x H	399 x 299 x 81 mm		
Additional height (inside)	63 mm		
Colour	Red	Blue	Grey
Order no.	21751*	21754*	21755*

EFR 4070 PPL conductive model

Colour	Black, conductive		
Order no.	21758*		

400 x 300 x 120 mm



EF 4120 PP

External dimensions L x W x H	399 x 299 x 120 mm		
Internal dimensions L x W x H	356 x 256 x 117 mm		
Usable height when stacked	105 mm		
Capacity	11.1 litres		
Load (max.)	15 kg		
Colour	Red	Blue	Grey
Order no.	14891	14894	14895

EF 4121 PP solid base, walls perforated

Internal dimensions L x W x H	356 x 256 x 117 mm		
Usable height when stacked	105 mm		
Colour	Red	Blue	Grey
Order no.	16151*	-	16155*

EF 4123 PP base and walls perforated

Internal dimensions L x W x H	356 x 256 x 114 mm		
Usable height when stacked	102 mm		
Capacity	10.6 litres		
Load (max.)	10 kg		
Colour	Red	Blue	Grey
Order no.	14901*	-	14905*

EF 4120 PPL conductive model

Colour	Black, conductive		
Order no.	14898		

EF 4130 PP

External dimensions L x W x H	399 x 299 x 130 mm		
Internal dimensions L x W x H	354 x 254 x 127 mm		
Usable height when stacked	117 mm		
Capacity	11.9 litres		
Load (max.)	15 kg		
Colour	Red	Blue	Grey
Order no.	15351*	15354*	15355*

EF 4131 PP solid base, walls perforated

Internal dimensions L x W x H	354 x 254 x 127 mm		
Usable height when stacked	117 mm		
Colour	Red	Blue	Grey
Order no.	15361*	-	15365*

EF 4130 PPL conductive model

Colour	Black, conductive
Order no.	15358*

400 x 300 x 130 mm

**EF 4140 PP**

External dimensions L x W x H	399 x 299 x 140 mm		
Internal dimensions L x W x H	354 x 254 x 137 mm		
Usable height when stacked	117 mm		
Capacity	12.8 litres		
Load (max.)	15 kg		
Colour	Red	Blue	Grey
Order no.	22271	22274	22275

EF 4141 PP solid base, walls perforated

Internal dimensions L x W x H	354 x 254 x 137 mm		
Usable height when stacked	117 mm		
Colour	Red	Blue	Grey
Order no.	22331*	-	22335*

EF 4143 PP base and walls perforated

Internal dimensions L x W x H	353 x 253 x 134 mm		
Usable height when stacked	114 mm		
Capacity	12.4 litres		
Load (max.)	10 kg		
Colour	Red	Blue	Grey
Order no.	22341*	-	22345*

EF 4140 PPL conductive model

Colour	Black, conductive
Order no.	22278

400 x 300 x 140 mm



Standard models

400 x 300 x 170 mm



EF 4170 PP

External dimensions L x W x H	399 x 299 x 170 mm		
Internal dimensions L x W x H	354 x 254 x 167 mm		
Usable height when stacked	147 mm		
Capacity	15.7 litres		
Load (max.)	15 kg		
Colour	Red	Blue	Grey
Order no.	22161	22164	22165

EF 4171 PP solid base, walls perforated

Internal dimensions L x W x H	354 x 254 x 167 mm		
Usable height when stacked	147 mm		
Colour	Red	Blue	Grey
Order no.	22171*	-	22175*

EF 4173 PP base and walls perforated

Internal dimensions L x W x H	354 x 254 x 164 mm		
Usable height when stacked	144 mm		
Capacity	15.2 litres		
Load (max.)	10 kg		
Colour	Red	Blue	Grey
Order no.	22181*	-	22185*

EF 4170 VB PP with ribbed base

Internal dimensions L x W x H	355 x 255 x 147 mm		
Usable height when stacked	127 mm		
Capacity	13.8 litres		
Load (max.)	50 kg		
Colour	Red	Blue	Grey
Order no.	23161*	-	23165*

EF 4170 PPL conductive model

Colour	Black, conductive		
Order no.	22168		

400 x 300 x 220 mm



EF 4220 PP

External dimensions L x W x H	399 x 299 x 220 mm		
Internal dimensions L x W x H	355 x 255 x 217 mm		
Usable height when stacked	197 mm		
Capacity	20.4 litres		
Load (max.)	15 kg		
Colour	Red	Blue	Grey
Order no.	14951	14954	14955

EF 4221 PP solid base, walls perforated

Internal dimensions L x W x H	355 x 255 x 217 mm		
Usable height when stacked	197 mm		
Colour	Red	Blue	Grey
Order no.	14961	-	14965*

EF 4223 PP base and walls perforated

Internal dimensions L x W x H	355 x 255 x 214 mm		
Usable height when stacked	194 mm		
Capacity	19.9 litres		
Load (max.)	10 kg		
Colour	Red	Blue	Grey
Order no.	14971	-	14975

EF 4220 PPL conductive model

Colour	Black, conductive		
Order no.	14958		

EF 4320 PP

External dimensions L x W x H	399 x 299 x 320 mm		
Internal dimensions L x W x H	354 x 253 x 316 mm		
Usable height when stacked	306 mm		
Capacity	29.7 litres		
Load (max.)	15 kg		
Colour	Red	Blue	Grey
Order no.	14741	14744	14745

EF 4320 PPL conductive model

Colour	Black, conductive		
Order no.	14748		

400 x 300 x 320 mm



EF 4440 PP

External dimensions L x W x H	399 x 399 x 420 mm		
Internal dimensions L x W x H	353 x 353 x 417 mm		
Usable height when stacked	397 mm		
Capacity	53.9 litres		
Load (max.)	15 kg		
Colour	Red	Blue	Grey
Order no.	22351*	22354*	22355*

EF 4441 PP solid base, walls perforated

Internal dimensions L x W x H	353 x 353 x 417 mm		
Usable height when stacked	397 mm		
Colour	Red	Blue	Grey
Order no.	22361*	-	22365*

EF 4443 PE base and walls perforated

Internal dimensions L x W x H	353 x 353 x 414 mm		
Usable height when stacked	394 mm		
Capacity	53.5 litres		
Load (max.)	10 kg		
Colour	Red	Blue	Grey
Order no.	22371*	-	22375*

400 x 400 x 420 mm



* = Article on request

Standard models

600 x 400 x 75 mm



EF 6070 PP

External dimensions L x W x H	599 x 399 x 75 mm		
Internal dimensions L x W x H	553 x 353 x 72 mm		
Usable height when stacked	60 mm		
Capacity	14.3 litres		
Load (max.)	20 kg		
Colour	Red	Blue	Grey
Order no.	22041	22044	22045

EF 6070 PPL conductive model

Colour	Black, conductive		
Order no.	22048		

600 x 400 x 81 mm



EFR 6070 PP extension frame

External dimensions L x W x H	599 x 399 x 81 mm		
Additional height (inside)	63 mm		
Colour	Red	Blue	Grey
Order no.	22071*	22074*	22075*

EK 6070 PPL conductive model

Colour	Black, conductive		
Order no.	22078		

EF 6120 PP

External dimensions L x W x H	599 x 399 x 120 mm		
Internal dimensions L x W x H	553 x 353 x 117 mm		
Usable height when stacked	97 mm		
Capacity	23.3 litres		
Load (max.)	20 kg		
Colour	Red	Blue	Grey
Order no.	92281	970309	92285

EF 6121 PP solid base, walls perforated

Internal dimensions L x W x H	553 x 353 x 117 mm		
Usable height when stacked	97 mm		
Colour	Red	Blue	Grey
Order no.	93601*	-	93605*

EF 6123 PP base and walls perforated

Internal dimensions L x W x H	552 x 352 x 114 mm		
Usable height when stacked	94 mm		
Capacity	22.7 litres		
Load (max.)	15 kg		
Colour	Red	Blue	Grey
Order no.	16141*	16144*	16145*

EF 6120 VB PP with ribbed base

Internal dimensions L x W x H	553 x 353 x 97 mm		
Usable height when stacked	77 mm		
Capacity	19.6 litres		
Load (max.)	50 kg		
Colour	Red	Blue	Grey
Order no.	93061*	-	93065*

EF 6120 PPL conductive model

Colour	Black, conductive		
Order no.	92288		

EF 6120 VB PPL conductive model

Colour	Black, conductive		
Order no.	92278*		

600 x 400 x 120 mm

**EF 6140 PP**

External dimensions L x W x H	599 x 399 x 140 mm		
Internal dimensions L x W x H	553 x 353 x 137 mm		
Usable height when stacked	117 mm		
Capacity	27.4 litres		
Load (max.)	20 kg		
Colour	Red	Blue	Grey
Order no.	22231	22234	22235

EF 6141 PP solid base, walls perforated

Internal dimensions L x W x H	553 x 353 x 137 mm		
Usable height when stacked	117 mm		
Colour	Red	Blue	Grey
Order no.	22241*	-	22245*

EF 6143 PP base and walls perforated

Internal dimensions L x W x H	553 x 353 x 134 mm		
Usable height when stacked	114 mm		
Capacity	26.8 litres		
Load (max.)	15 kg		
Colour	Red	Blue	Grey
Order no.	22251*	-	22255*

EF 6140 VB PP with ribbed base

Internal dimensions L x W x H	555 x 355 x 117 mm		
Usable height when stacked	97 mm		
Capacity	23.7 litres		
Load (max.)	50 kg		
Colour	Red	Blue	Grey
Order no.	23181*	-	23185*

EF 6140 PPL conductive model

Colour	Black, conductive		
Order no.	22238*		

EF 6140 VB PPL conductive model

Colour	Black, conductive		
Order no.	23188*		

600 x 400 x 140 mm



Standard models

600 x 400 x 150 mm



EF 6150 PP

External dimensions L x W x H	599 x 399 x 150 mm		
Internal dimensions L x W x H	553 x 353 x 147 mm		
Usable height when stacked	127 mm		
Capacity	29.4 litres		
Load (max.)	20 kg		
Colour	Red	Blue	Grey
Order no.	21951	21954	21955

EF 6151 PP solid base, walls perforated

Internal dimensions L x W x H	553 x 353 x 147 mm		
Usable height when stacked	127 mm		
Colour	Red	Blue	Grey
Order no.	21961*	-	21965*

EF 6153 PP base and walls perforated

Internal dimensions L x W x H	553 x 353 x 144 mm		
Usable height when stacked	124 mm		
Capacity	28.8 litres		
Load (max.)	15 kg		
Colour	Red	Blue	Grey
Order no.	21971*	-	21975*

EF 6150 VB PP with ribbed base

Internal dimensions L x W x H	555 x 355 x 127 mm		
Usable height when stacked	107 mm		
Capacity	26.0 litres		
Load (max.)	50 kg		
Colour	Red	Blue	Grey
Order no.	21891*	-	21895*

EF 6150 PPL conductive model

Colour	Black, conductive		
Order no.	21958		

EF 6150 VB PPL conductive model

Colour	Black, conductive		
Order no.	21898*		

600 x 400 x 170 mm



EF 6170 PP

External dimensions L x W x H	606 x 399 x 170 mm		
Internal dimensions L x W x H	570 x 370 x 166 mm		
Usable height when stacked	151 mm		
Capacity	34.2 litres		
Load (max.)	20 kg		
Colour	Red	Blue	Grey
Order no.	15371	15374	15375

EF 6170 PPL conductive model

Colour	Black, conductive		
Order no.	15378		

EF 6180 PP

External dimensions L x W x H	599 x 399 x 180 mm		
Internal dimensions L x W x H	553 x 353 x 176 mm		
Usable height when stacked	156 mm		
Capacity	35.4 litres		
Load (max.)	20 kg		
Colour	Red	Blue	Grey
Order no.	15661	15664	15665

EF 6181 PP solid base, walls perforated

Internal dimensions L x W x H	553 x 353 x 176 mm		
Usable height when stacked	156 mm		
Colour	Red	Blue	Grey
Order no.	22051*	-	22055*

EF 6183 PP base and walls perforated

Internal dimensions L x W x H	553 x 353 x 173 mm		
Usable height when stacked	153 mm		
Capacity	34.8 litres		
Load (max.)	15 kg		
Colour	Red	Blue	Grey
Order no.	22061*	-	22065*

EF 6180 VB PP with ribbed base

Internal dimensions L x W x H	555 x 355 x 157 mm		
Usable height when stacked	137 mm		
Capacity	31.8 litres		
Load (max.)	50 kg		
Colour	Red	Blue	Grey
Order no.	21981*	-	21985*

EF 6180 PPL conductive model

Colour	Black, conductive		
Order no.	15668		

EF 6180 VB PPL conductive model

Colour	Black, conductive		
Order no.	21988*		

600 x 400 x 180 mm**EF 6220 PP**

External dimensions L x W x H	599 x 399 x 220 mm		
Internal dimensions L x W x H	553 x 353 x 216 mm		
Usable height when stacked	196 mm		
Capacity	43.5 litres		
Load (max.)	20 kg		
Colour	Red	Blue	Grey
Order no.	14851	14854	14855

EF 6221 PP solid base, walls perforated

Internal dimensions L x W x H	553 x 353 x 216 mm		
Usable height when stacked	196 mm		
Colour	Red	Blue	Grey
Order no.	16091	-	16095

EF 6223 PP base and walls perforated

Internal dimensions L x W x H	553 x 353 x 213 mm		
Usable height when stacked	193 mm		
Capacity	42.9 litres		
Load (max.)	15 kg		
Colour	Red	Blue	Grey
Order no.	14861*	-	14865*

EF 6220 VB PP with ribbed base

Internal dimensions L x W x H	555 x 355 x 197 mm		
Usable height when stacked	177 mm		
Capacity	39.9 litres		
Load (max.)	50 kg		
Colour	Red	Blue	Grey
Order no.	21861*	-	21865*

EF 6220 PPL conductive model

Colour	Black, conductive		
Order no.	14858		

EF 6220 VB PPL conductive model

Colour	Black, conductive		
Order no.	21868*		

600 x 400 x 220 mm

Standard models

600 x 400 x 240 mm



EF 6240 PP

External dimensions L x W x H	599 x 399 x 240 mm		
Internal dimensions L x W x H	553 x 353 x 236 mm		
Usable height when stacked	216 mm		
Capacity	47.5 litres		
Load (max.)	20 kg		
Colour	Red	Blue	Grey
Order no.	22091	22094	22095

EF 6241 PP solid base, walls perforated

Internal dimensions L x W x H	553 x 353 x 236 mm		
Usable height when stacked	216 mm		
Colour	Red	Blue	Grey
Order no.	22141*	-	22145*

EF 6243 PP base and walls perforated

Internal dimensions L x W x H	553 x 353 x 234 mm		
Usable height when stacked	214 mm		
Capacity	46.9 litres		
Load (max.)	15 kg		
Colour	Red	Blue	Grey
Order no.	22151*	-	22155*

EF 6240 VB PP with ribbed base

Internal dimensions L x W x H	555 x 355 x 217 mm		
Usable height when stacked	197 mm		
Capacity	43.9 litres		
Load (max.)	50 kg		
Colour	Red	Blue	Grey
Order no.	22911*	-	22915*

EF 6240 PPL conductive model

Colour	Black, conductive		
Order no.	22098		

600 x 400 x 285 mm



EF 6280 PP

External dimensions L x W x H	599 x 399 x 285 mm		
Internal dimensions L x W x H	553 x 353 x 281 mm		
Usable height when stacked	261 mm		
Capacity	56.6 litres		
Load (max.)	20 kg		
Colour	Red	Blue	Grey
Order no.	21921	21924	21925

EF 6281 PP solid base, walls perforated

Internal dimensions L x W x H	551 x 351 x 281 mm		
Usable height when stacked	261 mm		
Colour	Red	Blue	Grey
Order no.	21931*	-	21935*

EF 6283 PP base and walls perforated

Internal dimensions L x W x H	553 x 353 x 279 mm		
Usable height when stacked	258 mm		
Capacity	56.0 litres		
Load (max.)	15 kg		
Colour	Red	Blue	Grey
Order no.	21941*	-	21945*

EF 6280 VB PP with ribbed base

Internal dimensions L x W x H	555 x 355 x 262 mm		
Usable height when stacked	242 mm		
Capacity	53.0 litres		
Load (max.)	50 kg		
Colour	Red	Blue	Grey
Order no.	21881*	-	21885*

EF 6280 PPL conductive model

Colour	Black, conductive		
Order no.	21928		

EF 6280 VB PPL conductive model

Colour	Black, conductive		
Order no.	21888*		

EF 6320 PP

External dimensions L x W x H	599 x 399 x 320 mm		
Internal dimensions L x W x H	553 x 353 x 316 mm		
Usable height when stacked	296 mm		
Capacity	63.7 litres		
Load (max.)	20 kg		
Colour	Red	Blue	Grey
Order no.	14831	14834	14835

EF 6321 PP solid base, walls perforated

Internal dimensions L x W x H	553 x 353 x 316 mm		
Usable height when stacked	296 mm		
Colour	Red	Blue	Grey
Order no.	16071	-	16075

EF 6323 PP base and walls perforated

Internal dimensions L x W x H	553 x 353 x 313 mm		
Usable height when stacked	293 mm		
Capacity	63.1 litres		
Load (max.)	15 kg		
Colour	Red	Blue	Grey
Order no.	14841*	-	14845*

EF 6320 VB PP with ribbed base

Internal dimensions L x W x H	553 x 353 x 296 mm		
Usable height when stacked	276 mm		
Capacity	60.2 litres		
Load (max.)	50 kg		
Colour	Red	Blue	Grey
Order no.	21871*	-	21875*

EF 6320 PPL conductive model

Colour	Black, conductive		
Order no.	14838		

EF 6320 VB PPL conductive model

Colour	Black, conductive		
Order no.	21878*		

600 x 400 x 320 mm



EF 6420 PP

External dimensions L x W x H	599 x 399 x 420 mm		
Internal dimensions L x W x H	553 x 353 x 416 mm		
Usable height when stacked	396 mm		
Capacity	83.8 litres		
Load (max.)	20 kg		
Colour	Red	Blue	Grey
Order no.	14921	14924	14925

EF 6421 PP solid base, walls perforated

Internal dimensions L x W x H	553 x 353 x 416 mm		
Usable height when stacked	396 mm		
Colour	Red	Blue	Grey
Order no.	14931*	-	14935

EF 6423 PP base and walls perforated

Internal dimensions L x W x H	553 x 353 x 413 mm		
Usable height when stacked	393 mm		
Capacity	83.2 litres		
Load (max.)	15 kg		
Colour	Red	Blue	Grey
Order no.	14941*	-	14945*

EF 6420 VB PP with ribbed base

Internal dimensions L x W x H	553 x 353 x 396 mm		
Usable height when stacked	376 mm		
Capacity	80.4 litres		
Load (max.)	50 kg		
Colour	Red	Blue	Grey
Order no.	21991*	-	21995*

EF 6420 PPL conductive model

Colour	Black, conductive		
Order no.	14928		

EF 6420 VB PPL conductive model

Colour	Black, conductive		
Order no.	21998*		

600 x 400 x 420 mm



* = Article on request

Standard models

800 x 600 x 320 mm



EF 8320 PP

External dimensions L x W x H	800 x 600 x 321 mm		
Internal dimensions L x W x H	755 x 555 x 307 mm		
Usable height when stacked	286 mm		
Capacity	122.0 litres		
Load (max.)	35 kg		
Colour	Red	Blue	Grey
Order no.	14881*	14884*	14885*

EF 8321 PP solid base, walls perforated

Internal dimensions L x W x H	755 x 555 x 307 mm		
Usable height when stacked	286 mm		
Colour	Red	Blue	Grey
Order no.	22131*	-	22135*

EF 8320 PPL conductive model

Colour	Black, conductive		
Order no.	14888*		

Special models

EF 6220 D11 PP one short side semi open

External dimensions L x W x H	599 x 399 x 220 mm		
Internal dimensions L x W x H	553 x 353 x 216 mm		
Usable height when stacked	196 mm		
Short side opening W x H	278 x 110 mm		
Capacity	43.5 litres		
Load (max.)	20 kg		
Colour	Red	Blue	Grey
Order no.	on request	93904	on request

SK 64102 PP dust flap

Colour	Transparent
Order no.	93930

600 x 400 x 220 mm

**EF 6320 B11 PP** one short side semi open

External dimensions L x W x H	599 x 399 x 320 mm		
Internal dimensions L x W x H	553 x 353 x 316 mm		
Usable height when stacked	296 mm		
Short side opening W x H	278 x 160 mm		
Capacity	63.7 litres		
Load (max.)	20 kg		
Colour	Red	Blue	Grey
Order no.	on request	93894	on request

SK 64152 PP dust flap

Colour	Transparent
Order no.	93920

600 x 400 x 320 mm

**EF 6420 A14 PP** one short side semi open

External dimensions L x W x H	599 x 399 x 420 mm		
Internal dimensions L x W x H	553 x 353 x 416 mm		
Usable height when stacked	396 mm		
Short side opening W x H	278 x 210 mm		
Capacity	83.8 litres		
Load (max.)	20 kg		
Colour	Red	Blue	Grey
Order no.	on request	93884	on request

SK 64202 PP dust flap

Colour	Transparent
Order no.	93910

600 x 400 x 420 mm



Special models

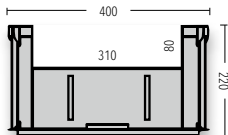
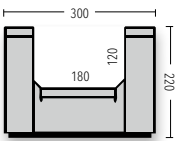
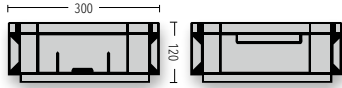
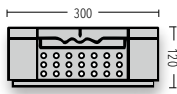

Basic dimensions 400 x 300 mm

External dimensions L x W x H		399 x 299 x 120 mm			
Internal dimensions L x W x H	Usable height when stacked	Capacity	Load (max.)	Order no. Red	Grey
EF 4120 G1 PP short sides perforated					
356 x 256 x 117 mm	105 mm	11.1 litres	15 kg	92201*	92205*

External dimensions L x W x H		399 x 299 x 120 mm			
Internal dimensions L x W x H	Usable height when stacked	Capacity	Load (max.)	Order no. Red	Grey
EF 4120 G2 PP one short side with label holder, one with underbarrel handle					
356 x 256 x 117 mm	105 mm	11.1 litres	15 kg	92211*	92215*
EF 4121 G2 PP solid base, walls perforated					
356 x 256 x 117 mm	105 mm	11.1 litres	15 kg	95611*	95615*
EF 4123 G2 PP base and walls perforated					
356 x 256 x 114 mm	102 mm	10.6 litres	10 kg	95631*	95635*

External dimensions L x W x H		399 x 299 x 140 mm			
Internal dimensions L x W x H	Usable height when stacked	Capacity	Load (max.)	Order no. Red	Grey
EF 4140 L1 PP one short side open at the top					
354 x 254 x 137 mm	117 mm	12.8 litres	15 kg	23191*	23195*

External dimensions L x W x H		399 x 299 x 220 mm			
Internal dimensions L x W x H	Usable height when stacked	Capacity	Load (max.)	Order no. Red	Grey
EF 4220 F1 PP one short side half open at the top, angled grip					
355 x 255 x 217 mm	197 mm	20.4 litres	15 kg	92251*	92255*
EF 4221 F1 PP solid base, walls perforated					
355 x 255 x 217 mm	197 mm	20.4 litres	15 kg	95641*	95645*
EF 4223 F1 PP base and walls perforated					
353 x 253 x 214 mm	194 mm	19.9 litres	10 kg	95661*	95665*

External dimensions L x W x H		399 x 299 x 220 mm			
Internal dimensions L x W x H	Usable height when stacked	Capacity	Load (max.)	Order no. Red	Grey
EF 4220 F3 PP one short side open at the top, with label holder					
355 x 255 x 217 mm	197 mm	20.4 litres	15 kg	92961*	92965*

External dimensions L x W x H		399 x 299 x 320 mm			
Internal dimensions L x W x H	Usable height when stacked	Capacity	Load (max.)	Order no. Red	Grey
EF 4320 H1 PP one short side ¾ open, optional flap					
354 x 253 x 316 mm	306 mm	29.7 litres	15 kg	95691*	95695*

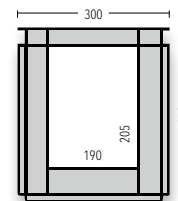

Basic dimensions 600 x 400 mm

External dimensions L x W x H		599 x 399 x 220 mm			
Internal dimensions L x W x H	Usable height when stacked	Capacity	Load (max.)	Order no. Red	Grey
EF 6220 D1 PP one short side semi open at the top					
553 x 353 x 216 mm	196 mm	43.5 litres	20 kg	92411*	92415*
EF 6221 D1 PP solid base, walls perforated					
553 x 353 x 216 mm	196 mm	43.5 litres	20 kg	95871*	95875*
EF 6223 D1 PP base and walls perforated					
553 x 353 x 213 mm	193 mm	42.9 litres	15 kg	95901*	95905*

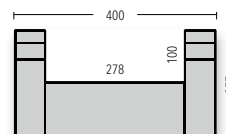

External dimensions L x W x H		599 x 399 x 220 mm			
Internal dimensions L x W x H	Usable height when stacked	Capacity	Load (max.)	Order no. Red	Grey
EF 6220 D5 PP one short side 2/3 open					
553 x 353 x 216 mm	196 mm	43.5 litres	20 kg	95851*	95855*
EF 6221 D5 PP solid base, walls perforated					
553 x 353 x 216 mm	196 mm	43.5 litres	20 kg	95861*	95865*
EF 6223 D5 PP base and walls perforated					
553 x 353 x 213 mm	193 mm	42.9 litres	15 kg	95891*	95895*

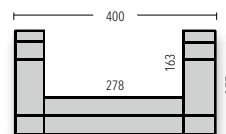

External dimensions L x W x H		599 x 399 x 220 mm			
Internal dimensions L x W x H	Usable height when stacked	Capacity	Load (max.)	Order no. Red	Grey
EF 6220 D8 PP one short side fully open					
553 x 353 x 216 mm	196 mm	43.5 litres	20 kg	92971*	92975*

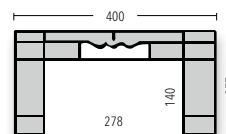

External dimensions L x W x H		599 x 399 x 220 mm			
Internal dimensions L x W x H	Usable height when stacked	Capacity	Load (max.)	Order no. Red	Grey
EF 6220 D12 PP reduced insertion depth, 12 mm more internal height when stacked					
553 x 353 x 216 mm	208 mm	42.9 litres	20 kg	on request	on request

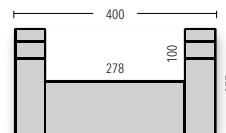

External dimensions L x W x H		599 x 399 x 240 mm			
Internal dimensions L x W x H	Usable height when stacked	Capacity	Load (max.)	Order no. Red	Grey
EF 6240 C1 PP one short side completely open					
553 x 353 x 236 mm	216 mm	47.5 litres	20 kg	92511*	92515*
EF 6241 C1 PP solid base, walls perforated					
553 x 353 x 236 mm	216 mm	47.5 litres	20 kg	92531*	92535*
EF 6243 C1 PP base and walls perforated					
553 x 353 x 234 mm	214 mm	46.9 litres	15 kg	92551*	92555*

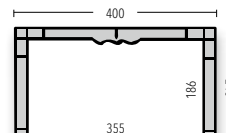

* = Article on request

Special models

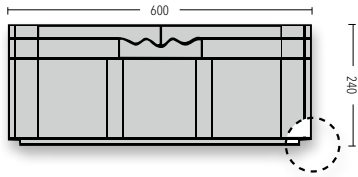

Basic dimensions 600 x 400 mm

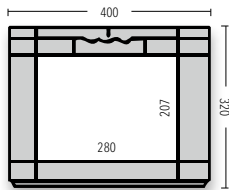
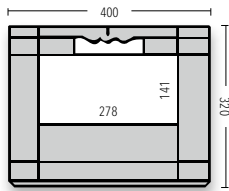
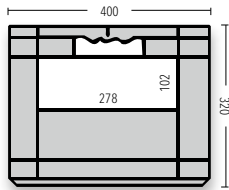

External dimensions L x W x H		599 x 399 x 240 mm			
Internal dimensions L x W x H	Usable height when stacked	Capacity	Load (max.)	Order no. Red	Grey
EF 6240 C2 PP reduced insertion depth, 10 mm more internal height when stacked					
553 x 353 x 236 mm	226 mm	47.5 litres	20 kg	92521*	92525*
EF 6241 C2 PP solid base, walls perforated					
553 x 353 x 236 mm	226 mm	47.5 litres	20 kg	92541*	92545*
EF 6243 C2 PP base and walls perforated					
553 x 353 x 234 mm	224 mm	46.9 litres	15 kg	92561*	92565*

External dimensions L x W x H		599 x 399 x 320 mm			
Internal dimensions L x W x H	Usable height when stacked	Capacity	Load (max.)	Order no. Red	Grey
EF 6320 B1 PP one short side semi open					
553 x 353 x 316 mm	296 mm	63.7 litres	20 kg	92601*	92605*
EF 6321 B1 PP solid base, walls perforated					
553 x 353 x 316 mm	296 mm	63.7 litres	20 kg	92661*	92665*
EF 6323 B1 PP base and walls perforated					
553 x 353 x 313 mm	293 mm	63.1 litres	15 kg	92721*	92725*

External dimensions L x W x H		599 x 399 x 320 mm			
Internal dimensions L x W x H	Usable height when stacked	Capacity	Load (max.)	Order no. Red	Grey
EF 6320 B2 PP one short side 2/3 open					
553 x 353 x 316 mm	296 mm	63.7 litres	20 kg	92611*	92615*
EF 6321 B2 PP solid base, walls perforated					
553 x 353 x 316 mm	296 mm	63.7 litres	20 kg	92671*	92675*
EF 6323 B2 PP base and walls perforated					
553 x 353 x 313 mm	293 mm	63.1 litres	15 kg	92731*	92735*

External dimensions L x W x H		599 x 399 x 320 mm			
Internal dimensions L x W x H	Usable height when stacked	Capacity	Load (max.)	Order no. Red	Grey
EF 6320 B3 PP one short side completely open					
553 x 353 x 316 mm	296 mm	63.7 litres	20 kg	92621*	92625*
EF 6321 B3 PP solid base, walls perforated					
553 x 353 x 316 mm	296 mm	63.7 litres	20 kg	92681*	92685*
EF 6323 B3 PP base and walls perforated					
553 x 353 x 313 mm	293 mm	63.1 litres	15 kg	92741*	92745*

External dimensions L x W x H		599 x 399 x 320 mm			
Internal dimensions L x W x H	Usable height when stacked	Capacity	Load (max.)	Order no. Red	Grey
EF 6320 B5 PP one short side semi open, with latching sheet steel slider					
553 x 353 x 316 mm	296 mm	63.7 litres	20 kg	92641*	92645*
EF 6321 B5 PP solid base, walls perforated					
553 x 353 x 316 mm	296 mm	63.7 litres	20 kg	92701*	92705*
EF 6323 B5 PP base and walls perforated					
553 x 353 x 313 mm	293 mm	63.1 litres	15 kg	92761*	92765*

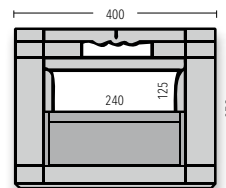

External dimensions L x W x H		599 x 399 x 320 mm			
Internal dimensions L x W x H	Usable height when stacked	Capacity	Load (max.)	Order no. Red	Grey
EF 6320 B6 PP one short side open at the top					
553 x 353 x 316 mm	296 mm	63.7 litres	20 kg	92651*	92655*
EF 6321 B6 PP solid base, walls perforated					
553 x 353 x 316 mm	296 mm	63.7 litres	20 kg	92711*	92715*
EF 6323 B6 PP base and walls perforated					
553 x 353 x 313 mm	293 mm	63.1 litres	15 kg	92771*	92775*

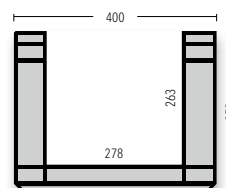

External dimensions L x W x H		599 x 399 x 320 mm			
Internal dimensions L x W x H	Usable height when stacked	Capacity	Load (max.)	Order no. Red	Grey
EF 6320 B7 PP one short side with special label holder					
553 x 353 x 316 mm	296 mm	63.7 litres	20 kg	95801*	95805*
EF 6321 B7 PP solid base, walls perforated					
553 x 353 x 316 mm	296 mm	63.7 litres	20 kg	95821*	95825*
EF 6323 B7 PP base and walls perforated					
553 x 353 x 313 mm	293 mm	63.1 litres	15 kg	95841*	95845*

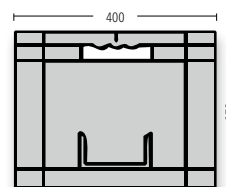

External dimensions L x W x H		599 x 399 x 320 mm			
Internal dimensions L x W x H	Usable height when stacked	Capacity	Load (max.)	Order no. Red	Grey
EF 6320 B8 PP one short side open at the top					
553 x 353 x 316 mm	296 mm	63.7 litres	20 kg	95791*	95795*
EF 6321 B8 PP solid base, walls perforated					
553 x 353 x 316 mm	296 mm	63.7 litres	20 kg	95811*	95815*
EF 6323 B8 PP base and walls perforated					
553 x 353 x 313 mm	293 mm	63.1 litres	15 kg	95831*	95835*

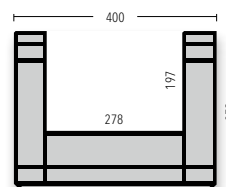

External dimensions L x W x H		599 x 399 x 320 mm			
Internal dimensions L x W x H	Usable height when stacked	Capacity	Load (max.)	Order no. Red	Grey
EF 6320 B9 PP one short side fully open					
553 x 353 x 316 mm	296 mm	63.7 litres	20 kg	92981*	92985*

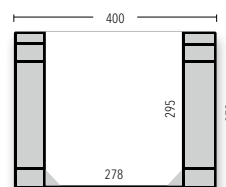

External dimensions L x W x H		599 x 399 x 320 mm			
Internal dimensions L x W x H	Usable height when stacked	Capacity	Load (max.)	Order no. Red	Grey
EF 6320 B4 PP one long side fully open					
553 x 353 x 316 mm	296 mm	63.7 litres	20 kg	92631*	92635*
EF 6321 B4 PP solid base, walls perforated					
553 x 353 x 316 mm	296 mm	63.7 litres	20 kg	92691*	92695*
EF 6323 B4 PP base and walls perforated					
553 x 353 x 313 mm	293 mm	63.1 litres	15 kg	92751*	92755*

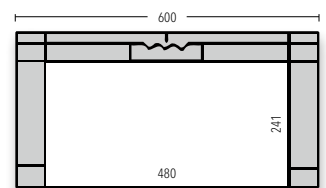

* = Article on request

Special models



Basic dimensions 600 x 400 mm

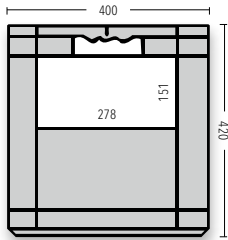

External dimensions L x W x H

599 x 399 x 420 mm

Internal dimensions L x W x H	Usable height when stacked	Capacity	Load (max.)	Order no. Red	Grey
EF 6420 A1 PP one short side semi open					
553 x 353 x 416 mm	396 mm	83.8 litres	20 kg	92801*	92805*
EF 6421 A1 PP solid base, walls perforated					
553 x 353 x 416 mm	396 mm	83.8 litres	20 kg	92851*	92855*
EF 6423 A1 PP base and walls perforated					
553 x 353 x 413 mm	393 mm	83.2 litres	15 kg	92901*	92905*

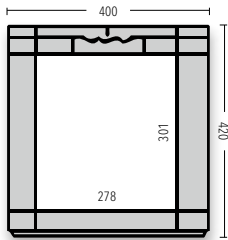

External dimensions L x W x H

599 x 399 x 420 mm

Internal dimensions L x W x H	Usable height when stacked	Capacity	Load (max.)	Order no. Red	Grey
EF 6420 A2 PP one short side fully open					
553 x 353 x 416 mm	396 mm	83.8 litres	20 kg	92811*	92815*
EF 6421 A2 PP solid base, walls perforated					
553 x 353 x 416 mm	396 mm	83.8 litres	20 kg	92861*	92865*

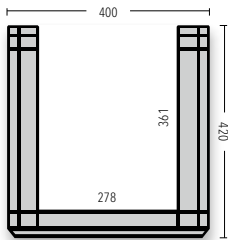

External dimensions L x W x H

599 x 399 x 420 mm

Internal dimensions L x W x H	Usable height when stacked	Capacity	Load (max.)	Order no. Red	Grey
EF 6420 A3 PP one short side fully open					
553 x 353 x 416 mm	396 mm	83.8 litres	20 kg	92821*	92825*
EF 6421 A3 PP solid base, walls perforated					
553 x 353 x 416 mm	396 mm	83.8 litres	20 kg	92871*	92875*
EF 6423 A3 PP base and walls perforated					
553 x 353 x 413 mm	393 mm	83.2 litres	15 kg	92921*	92925*

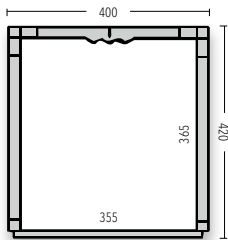

External dimensions L x W x H

599 x 399 x 420 mm

Internal dimensions L x W x H	Usable height when stacked	Capacity	Load (max.)	Order no. Red	Grey
EF 6420 A4 PP one short side fully open					
553 x 353 x 416 mm	396 mm	83.8 litres	20 kg	92831*	92835*
EF 6421 A4 PP solid base, walls perforated					
553 x 353 x 416 mm	396 mm	83.8 litres	20 kg	92881*	92885*
EF 6423 A4 PP base and walls perforated					
553 x 353 x 413 mm	393 mm	83.2 litres	15 kg	92931*	92935*

External dimensions L x W x H		599 x 399 x 420 mm			
Internal dimensions L x W x H	Usable height when stacked	Capacity	Load (max.)	Order no. Red	Grey
EF 6420 A10 PP		one short side fully open			
553 x 353 x 416 mm	396 mm	83.8 litres	20 kg	95701*	95705*
EF 6421 A10 PP		solid base, walls perforated			
553 x 353 x 416 mm	396 mm	83.8 litres	20 kg	95731*	95735*
EF 6423 A10 PP		base and walls perforated			
553 x 353 x 413 mm	393 mm	83.2 litres	15 kg	95761*	95765*

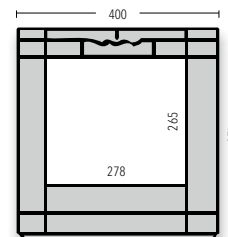

External dimensions L x W x H		599 x 399 x 420 mm			
Internal dimensions L x W x H	Usable height when stacked	Capacity	Load (max.)	Order no. Red	Grey
EF 6420 A5 PP		one long side semi open			
553 x 353 x 416 mm	396 mm	83.8 litres	20 kg	92841*	92845*
EF 6421 A5 PP		solid base, walls perforated			
553 x 353 x 416 mm	396 mm	83.8 litres	20 kg	92891*	92895*
EF 6423 A5 PP		base and walls perforated			
553 x 353 x 413 mm	393 mm	83.2 litres	15 kg	92941*	92945*

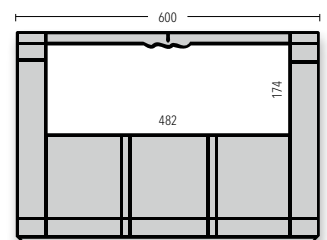

External dimensions L x W x H		599 x 399 x 420 mm			
Internal dimensions L x W x H	Usable height when stacked	Capacity	Load (max.)	Order no. Red	Grey
EF 6420 A7 PP		one long side fully open			
553 x 353 x 416 mm	396 mm	83.8 litres	20 kg	95721*	95725*
EF 6421 A7 PP		solid base, walls perforated			
553 x 353 x 416 mm	396 mm	83.8 litres	20 kg	95751*	95755*
EF 6423 A7 PP		base and walls perforated			
553 x 353 x 413 mm	393 mm	83.2 litres	15 kg	95781*	95785*

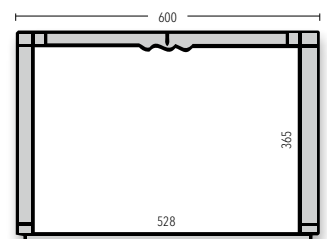

External dimensions L x W x H		599 x 399 x 420 mm			
Internal dimensions L x W x H	Usable height when stacked	Capacity	Load (max.)	Order no. Red	Grey
EF 6420 A9 PP		one long side open at the top, with special label holder			
553 x 353 x 416 mm	396 mm	83.8 litres	20 kg	95711*	95715*
EF 6421 A9 PP		solid base, walls perforated			
553 x 353 x 416 mm	396 mm	83.8 litres	20 kg	95741*	95745*
EF 6423 A9 PP		base and walls perforated			
553 x 353 x 413 mm	393 mm	83.2 litres	15 kg	95771*	95775*

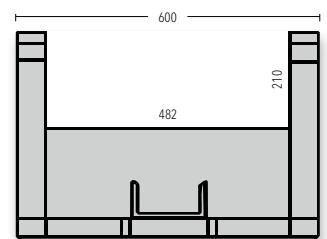

Basic dimensions 800 x 600 mm

External dimensions L x W x H		800 x 600 x 321 mm			
Internal dimensions L x W x H	Usable height when stacked	Capacity	Load (max.)	Order no. Red	Grey
EF 8320 J1 PP		one short side semi open, with open grip			
755 x 555 x 307 mm	306 mm	122.0 litres	35 kg	95921*	95925*
EF 8321 J1 PP		solid base, walls perforated			
755 x 555 x 307 mm	286 mm	122.0 litres	35 kg	95931*	95935*

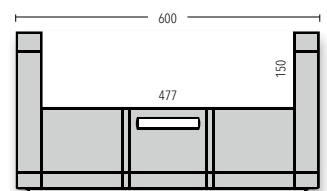

* = Article on request

Lids

Basic dimensions 200 x 150 mm

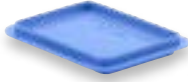

EF-D 21 PP drop-on lid				EF-D 21 PPL
Colour	Red	Blue	Grey	Black, conductive
Order no.	21791	21794	21795	21798
EF-D 21-H PP with hooks**				EF-D 21-H PPL
Colour	Red	Blue	Grey	Black, conductive
Order no.	39911	39914	39915	39918*
EF-D 21-S PP with hinges				EF-D 21-S PPL
Colour	Red	Blue	Grey	Black, conductive
Order no.	21001	21004	21005	21008
EF-D 21-SF PP factory-fitted lid				EF-D 21-SF PPL
Colour	Red	Blue	Grey	Black, conductive
Order no.	21011*	21014*	21015*	21018*

** Lid clips available on request

Basic dimensions 300 x 200 mm



EF-D 32 PP drop-on lid				EF-D 32 PPL
Colour	Red	Blue	Grey	Black, conductive
Order no.	22281	22284	22285	22288
EF-D 32-H PP with hooks**				EF-D 32-H PPL
Colour	Red	Blue	Grey	Black, conductive
Order no.	39921	39924	39925	39928
EF-D 32-S PP with hinges				EF-D 32-S PPL
Colour	Red	Blue	Grey	Black, conductive
Order no.	21021	21024	21025	21028
EF-D 32-SF PP factory-fitted lid				EF-D 32-SF PPL
Colour	Red	Blue	Grey	Black, conductive
Order no.	21031*	21034*	21035*	21038*

** Lid clips available on request

Basic dimensions 400 x 300 mm



EF-D 43 PP drop-on lid				EF-D 43 PPL
Colour	Red	Blue	Grey	Black, conductive
Order no.	15031	15034	15035	15038
EF-D 43-H PP with hooks**				EF-D 43-H PPL
Colour	Red	Blue	Grey	Black, conductive
Order no.	39931	39934	39935	39938
EF-D 43-S PP with hinges				EF-D 43-S PPL
Colour	Red	Blue	Grey	Black, conductive
Order no.	21041	21044	21045	21048
EF-D 43-SF PP factory-fitted lid				EF-D 43-SF PPL
Colour	Red	Blue	Grey	Black, conductive
Order no.	21051*	21054*	21055*	21058*

** Lid clips available on request

EF-D 44 PP drop-on lid				EF-D 44 PPL
Colour	Red	Blue	Grey	Black, conductive
Order no.	22291*	22294*	22295*	22298*
EF-D 44-S PP with hinges				EF-D 44-S PPL
Colour	Red	Blue	Grey	Black, conductive
Order no.	21061*	21064*	21065*	21068*
EF-D 44-SF PP factory-fitted lid				EF-D 44-SF PPL
Colour	Red	Blue	Grey	Black, conductive
Order no.	21071*	21074*	21075*	21078*

Basic dimensions 400 x 400 mm



EF-D 64 PP drop-on lid				EF-D 64 PPL
Colour	Red	Blue	Grey	Black, conductive
Order no.	15041	15044	15045	15048
EF-D 64-H PP with hooks**				EF-D 64-H PPL
Colour	Red	Blue	Grey	Black, conductive
Order no.	39941	39944	39945	39948
EF-D 64-S PP with hinges				EF-D 64-S PPL
Colour	Red	Blue	Grey	Black, conductive
Order no.	21081	21084	21085	21088
EF-D 64-SF PP factory-fitted lid				EF-D 64-SF PPL
Colour	Red	Blue	Grey	Black, conductive
Order no.	21091*	21094*	21095*	21098*
FB-D 604 PP snap-on lid				
Colour	Red	Blue	Grey	
Order no.	15051*	15054	15055*	

Basic dimensions 600 x 400 mm

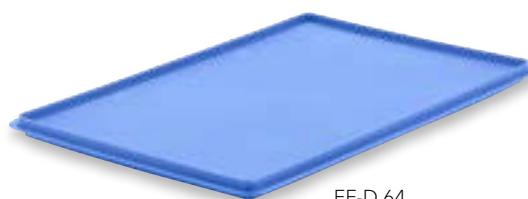

EF-D 64



FB-D 604

** Lid clips available on request

Lid clips	
Colour	White
Order no.	99227



Lid clip (on request)



Hinged lid with reinforcing ring, assembled



Lid with hooks

Pallet covers

Basic dimensions 800 x 600 mm



ADH 86 PP pallet cover with banding slots and indentations for dollies

External dimensions L x W x H 814 x 614 x 44 mm

Height when stacked 30 mm

Colour Black

Order no. 93628

Basic dimensions 1200 x 800 mm

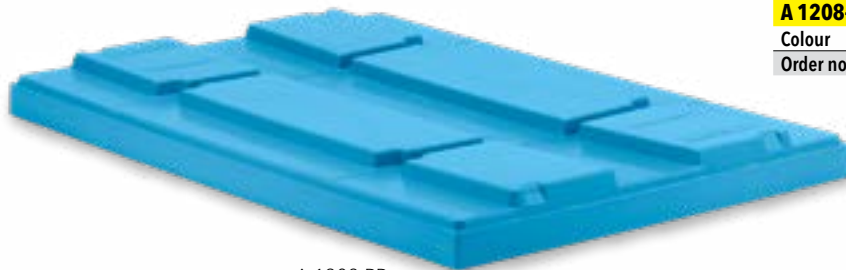

A 1208 PP

A 1208 PP pallet cover

Colour Blue

Order no. 39704

A 1208-1 PP pallet cover

Colour Blue

Order no. 35614



A 1208-1 PP

Accessories

GV-EF PP

Packaging unit	50 units		
Colour	Red	Blue	Grey
Order no.	22081	22084	22085

GV-EF 3 PP smooth model

Packaging unit	1 unit		
Colour	Red	Grey	
Order no.	22301	22325	

GV-EF PPL conductive model

Colour	Black, conductive		
Order no.	22088		

Other colours on request

Grip closure

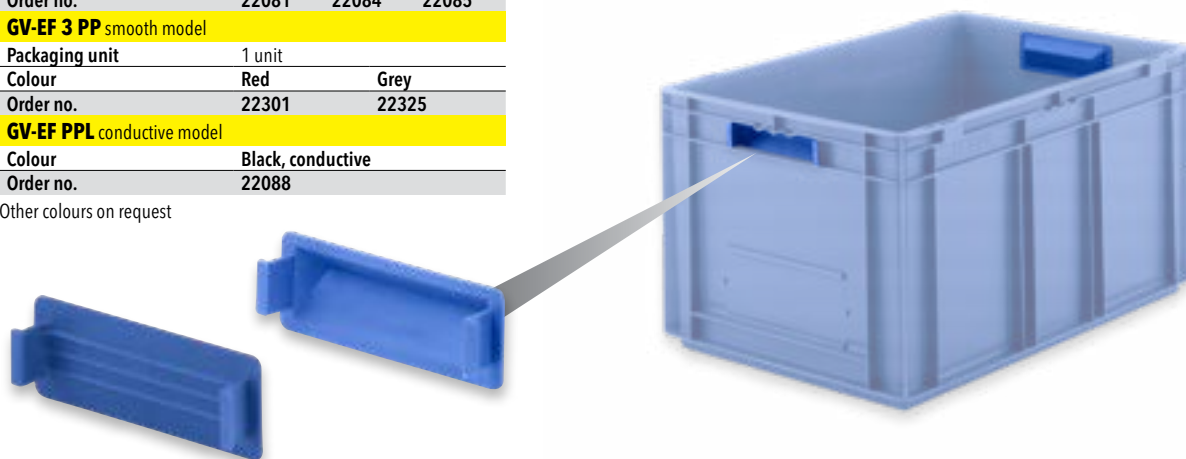

EF-E

For containers	all EF containers
Packaging unit	50 units
Order no.	16010

Label holder

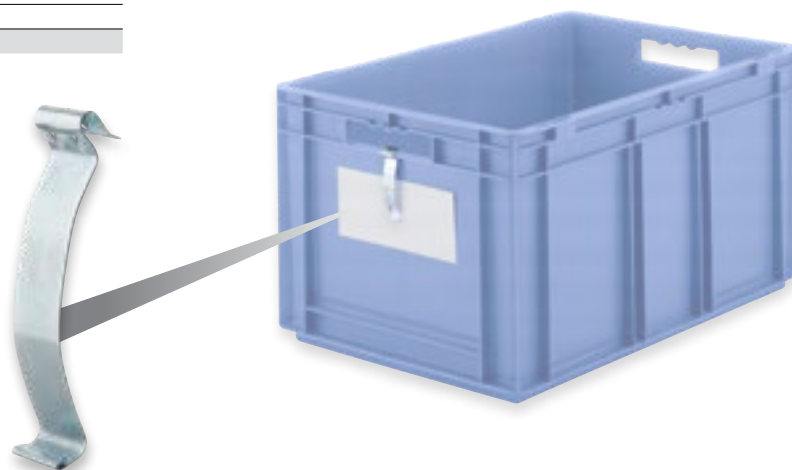

Accessories and Roll-Fix trolleys

Connection clamp



EFK	
For containers	400 x 300 and 600 x 400 mm
Packaging unit	50 units
Order no.	22120*



Roll-Fix 400 x 300 mm



RO 340 PP with plastic castors	
For containers	400 x 300 mm
External dimensions L x W x H	400 x 300 x 125 mm
Height of rim	15 mm
Swivel castors Ø	80 mm
Load capacity (max.)	200 kg
Colour	Red Grey
Order no.	- 23095*

Roll-Fix 600 x 400 mm



Roll-Fix RO 460

RO 460 PP with plastic castors	
For containers	600 x 400 mm
External dimensions L x W x H	594 x 396 x 150 mm
Height of rim	15 mm
Swivel castors Ø	80 mm
Load capacity (max.)	200 kg
Colour	Red Grey
Order no.	22201 22205

RO 461 PP with solid rubber castors	
Colour	Red Grey
Order no.	22211 22215

RO 463 PPL conductive model	
Colour	Black
Order no.	22190



Roll-Fix RO 461



Roll-Fix RO 463

Dollies

RLP 86 PP Dolly

External dimensions L x W x H	800 x 600 x 200 mm
-------------------------------	--------------------

Stacking height (max.)	1,800 mm
------------------------	----------

Height when stacked	130 mm
---------------------	--------

Fork clearance	115 mm
----------------	--------

Swivel and fixed castors Ø	125 mm
----------------------------	--------

Load capacity (max.)	450 kg
----------------------	--------

Colour	Black
--------	-------

Order no.	93608
-----------	-------

Basic dimensions 800 x 600 mm



MF - Bestseller for decades

The MF container is another favourite of our regular customers. It is characterised by a wide variety of dimensions and is very popular in the ESD, PPL3 electrically conductive model.

A sturdy, completely reliable container for storage and transport.

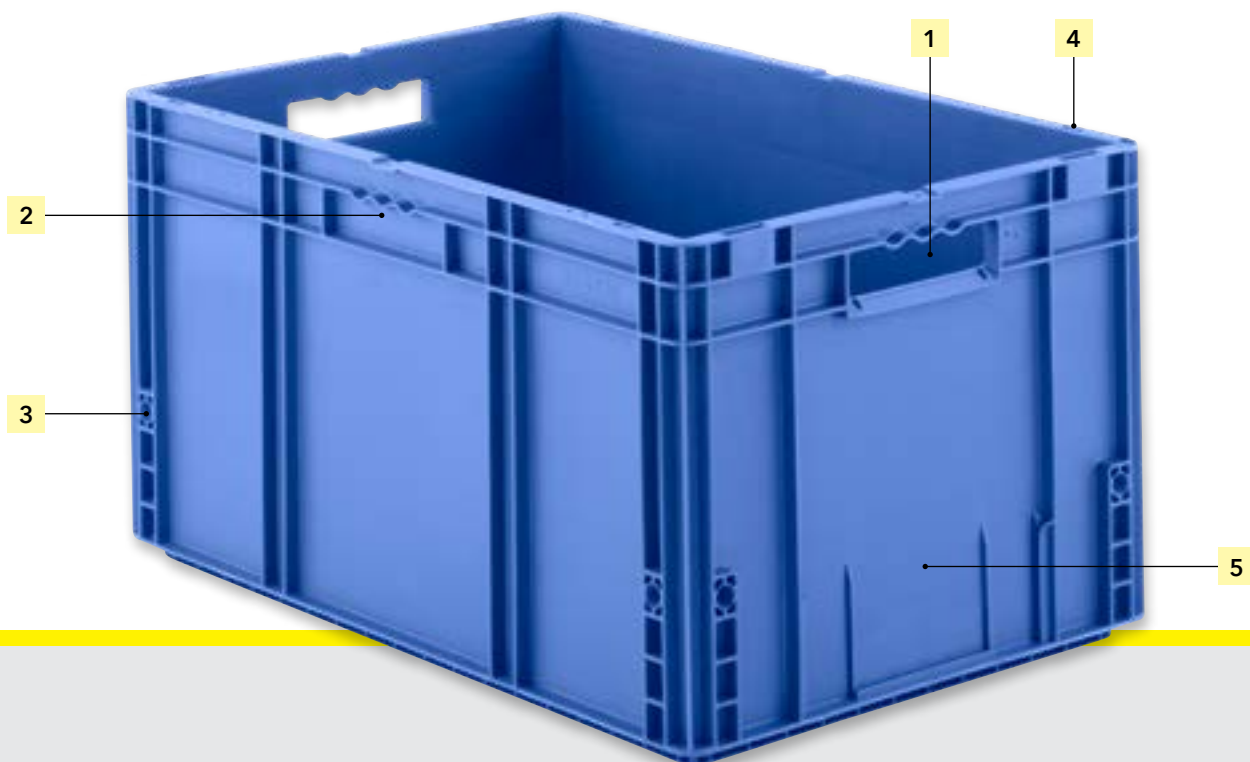

1| Ergonomic open grip* in both short sides, except for heights ≤ 120 mm



2| Closed grip* on both long sides, except for heights ≤ 120 mm



3| Sturdy corner design thanks to ribbed construction, with holes for alignment



4| Lifting slots for handling devices



5| Label holders with label holder on one long and one short side

* Various grip types (see individual images)



Key facts

- Storage and transport containers
- A favourite of our regular customers since the 1980s

Typical customer applications

- Available from stock
- Wide range of sizes available
- As a conductive model

Standard base
(max. load 30 kg)

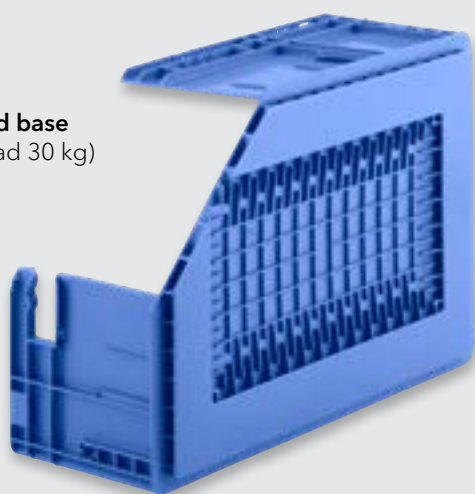

**Reinforced
welded base VS01**
(max. load 70 kg)



Bases optionally with water drainage holes in accordance with VDS guideline for categorisation in HHS 3.

Standard colours:



Standard model

200 x 150 x 120 mm



MF 2120 PP

External dimensions L x W x H	198 x 149 x 120 mm	
Internal dimensions L x W x H	160 x 111 x 118 mm	
Usable height when stacked	103 mm	
Capacity	2.0 litres	
Load (max.)	10 kg	
Colour	Blue	Grey
Order no.	39044	39045

MF 2120 PPL conductive model

Colour	Black, conductive	
Order no.	39048	

300 x 200 x 120 mm



MF 3120 PP

External dimensions L x W x H	298 x 198 x 120 mm	
Internal dimensions L x W x H	267 x 168 x 117 mm	
Usable height when stacked	102 mm	
Capacity	5.2 litres	
Load (max.)	15 kg	
Colour	Blue	Grey
Order no.	39304	39305

MF 3120 VB01 PP with ribbed base

Internal dimensions L x W x H	267 x 168 x 102 mm	
Usable height when stacked	87 mm	
Capacity	4.2 litres	
Load (max.)	25 kg	
Colour	Blue	Grey
Order no.	37364*	37365*

MF 3120 PPL conductive model

Colour	Black, conductive	
Order no.	39308	

MF 4060 PP

External dimensions L x W x H	396 x 297 x 60 mm	
Internal dimensions L x W x H	366 x 267 x 42 mm	
Usable height when stacked	27 mm	
Capacity	4.1 litres	
Load (max.)	20 kg	
Colour	Blue	Grey
Order no.	38734	38735

MF 4060 PPL conductive model

Colour	Black, conductive	
Order no.	38738	

400 x 300 x 60 mm

**MF 4120 PP**

External dimensions L x W x H	396 x 297 x 120 mm	
Internal dimensions L x W x H	360 x 261 x 102 mm	
Usable height when stacked	87 mm	
Capacity	10.0 litres	
Load (max.)	20 kg	
Colour	Blue	Grey
Order no.	39314	39315

MF 4120 PPL conductive model

Colour	Black, conductive	
Order no.	39318	

400 x 300 x 120 mm

**MF 4170 PP**

External dimensions L x W x H	396 x 297 x 170 mm	
Internal dimensions L x W x H	366 x 267 x 152 mm	
Usable height when stacked	137 mm	
Capacity	14.6 litres	
Load (max.)	20 kg	
Colour	Blue	Grey
Order no.	39324	39325

MF 4170 PPL conductive model

Colour	Black, conductive	
Order no.	39328	

400 x 300 x 170 mm



Standard model

400 x 300 x 220 mm



MF 4220 PP		
External dimensions L x W x H	396 x 297 x 220 mm	
Internal dimensions L x W x H	366 x 267 x 202 mm	
Usable height when stacked	187 mm	
Capacity	19.7 litres	
Load (max.)	20 kg	
Colour	Blue	Grey
Order no.	39334	39335
MF 4220 PPL conductive model		
Colour	Black, conductive	
Order no.	39338	

400 x 300 x 270 mm



MF 4270 PP		
External dimensions L x W x H	396 x 297 x 270 mm	
Internal dimensions L x W x H	366 x 267 x 252 mm	
Usable height when stacked	237 mm	
Capacity	24.3 litres	
Load (max.)	20 kg	
Colour	Blue	Grey
Order no.	39494	39495
MF 4270 PPL conductive model		
Colour	Black, conductive	
Order no.	39498*	

MF 6120 PP

External dimensions L x W x H	594 x 396 x 120 mm	
Internal dimensions L x W x H	564 x 366 x 102 mm	
Usable height when stacked	87 mm	
Capacity	21.0 litres	
Load (max.)	30 kg	
Colour	Blue	Grey
Order no.	970088	970090

MF 6120 PPL conductive model

Colour	Black, conductive	
Order no.	970091*	

600 x 400 x 120 mm

**MF 6170 PP**

External dimensions L x W x H	594 x 396 x 168 mm	
Internal dimensions L x W x H	564 x 366 x 150 mm	
Usable height when stacked	135 mm	
Capacity	30.8 litres	
Load (max.)	30 kg	
Colour	Blue	Grey
Order no.	39364	39365

MF 6170 PPL conductive model

Colour	Black, conductive	
Order no.	39368	

600 x 400 x 170 mm



Standard model

600 x 400 x 220 mm



MF 6220 PP

External dimensions L x W x H	594 x 396 x 220 mm	
Internal dimensions L x W x H	564 x 366 x 202 mm	
Usable height when stacked	187 mm	
Capacity	41.6 litres	
Load (max.)	30 kg	
Colour	Blue	Grey
Order no.	1142384	1142385

MF 6220 PPL conductive model

Colour	Black, conductive	
Order no.	1142388	

600 x 400 x 270 mm



MF 6270 PP

External dimensions L x W x H	594 x 396 x 270 mm	
Internal dimensions L x W x H	564 x 366 x 252 mm	
Usable height when stacked	237 mm	
Capacity	52.0 litres	
Load (max.)	30 kg	
Colour	Blue	Grey
Order no.	39384	39385

MF 6270 PPL conductive model

Colour	Black, conductive	
Order no.	39388	

MF 6320 PP

External dimensions L x W x H	594 x 396 x 320 mm	
Internal dimensions L x W x H	564 x 366 x 302 mm	
Usable height when stacked	287 mm	
Capacity	62.3 litres	
Load (max.)	30 kg	
Colour	Blue	Grey
Order no.	39394	39395

MF 6320 PPL conductive model

Colour	Black, conductive	
Order no.	39398	

600 x 400 x 320 mm

**MF 6420 PP**

External dimensions L x W x H	594 x 396 x 420 mm	
Internal dimensions L x W x H	564 x 366 x 402 mm	
Usable height when stacked	387 mm	
Capacity	82.9 litres	
Load (max.)	30 kg	
Colour	Blue	Grey
Order no.	39404	39405

MF 6420 PPL conductive model

Colour	Black, conductive	
Order no.	39408	

600 x 400 x 420 mm



Lids

Basic dimensions 300 x 200 mm



MF-D 32 PP drop-on lid			MF-D 32 PPL
Colour	Blue	Grey	Black, conductive
Order no.	39464	39465	39468
MF-D 32-H PP with hooks**			MF-D 32-H PPL
Colour	Blue	Grey	Black, conductive
Order no.	39854	39855*	39858*
MF-D 32-S PP with hinges			MF-D 32-S PPL
Colour	Blue	Grey	Black, conductive
Order no.	39474	39475	39478
MF-D 32-SF PP factory-fitted lid			MF-D 32-SF PPL
Colour	Blue	Grey	Black, conductive
Order no.	39484*	39485*	39488*

** Lid clips available on request

Basic dimensions 400 x 300 mm

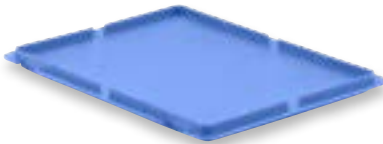

MF-D 43 PP drop-on lid with banding slots on all sides			MF-D 43 PPL
Colour	Blue	Grey	Black, conductive
Order no.	39714	39715	39718
MF-D 43-H PP with hooks**			MF-D 43-H PPL
Colour	Blue	Grey	Black, conductive
Order no.	39724	39725	39728
MF-D 43-S PP with hinges			MF-D 43-S PPL
Colour	Blue	Grey	Black, conductive
Order no.	39864	39865	39868*
MF-D 43-SF PP factory-fitted lid			MF-D 43-SF PPL
Colour	Blue	Grey	Black, conductive
Order no.	39734*	39735*	39738*

** Lid clips available on request

Basic dimensions 600 x 400 mm

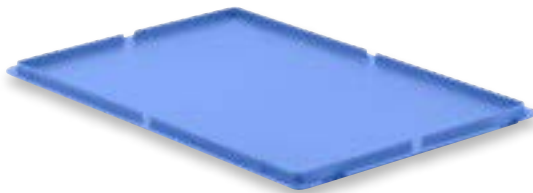

MF-D 64 PP drop-on lid with banding slots on all sides			MF-D 64 PPL
Colour	Blue	Grey	Black, conductive
Order no.	39744	39745	39748
MF-D 64-H PP with hooks**			MF-D 64-H PPL
Colour	Blue	Grey	Black, conductive
Order no.	39754	39755	39758
MF-D 64-S PP with hinges			MF-D 64-S PPL
Colour	Blue	Grey	Black, conductive
Order no.	39874	39875	39878
MF-D 64-SF PP factory-fitted lid			MF-D 64-SF PPL
Colour	Blue	Grey	Black, conductive
Order no.	39764*	39765*	39768*

** Lid clips available on request

Lid clips	
Colour	White
Order no.	99227



Lid with hooks



Hinged lid with reinforcing ring, assembled



Lid clip (on request)

Pallet covers and grip closures

A 1208 PP pallet cover

Colour	Blue
Order no.	39704

A 1208-1 PP pallet cover

Colour	Blue
Order no.	35614

Basic dimensions 1200 x 800 mm

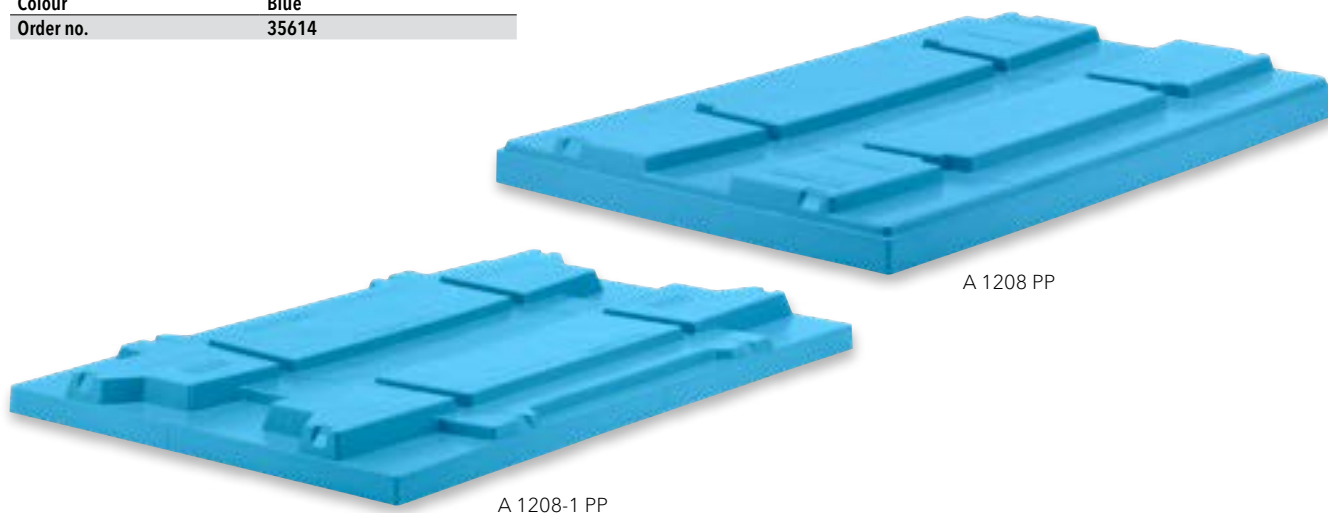

GV-MF PP

Packaging unit	1 unit	
Colour	Blue	Grey
Order no.	39794	39795

GV-MF 3 PP smooth model

Packaging unit	1 unit	
Colour	Blue	Grey
Order no.	22374	22385

Other colours on request

Grip closure

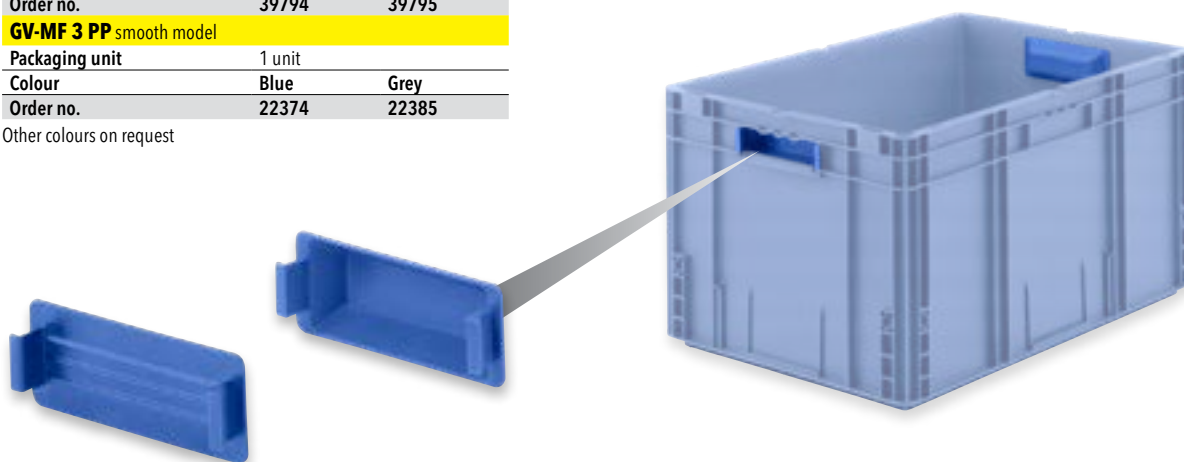

Dividers for basic dimensions 600 x 400 mm



Divider holder
For ELB, LTF and LTB

TWH 1 PP for lengthwise and crosswise dividers	
Quantity required	Two per divider
Colour	Black
Order no.	187858

Divider holder
For MF

TWH 2 PP for lengthwise and crosswise dividers	
Quantity required	Two per divider
Colour	Grey
Order no.	187859*

Partitioning examples for 130 mm dividers

Standard perforations up to 8-way crosswise
(3 per long side and 1 per short side)

Custom hole patterns are available
for orders of 500 containers or more



2-way crosswise partitioning*
Compartment size: 278 x 366 mm



1 x QTW 130-0
2 x TWH 1

2-way lengthwise partitioning*
Compartment size: 566 x 178 mm

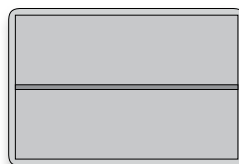

1 x LTW 130-0
2 x TWH 1

3-way crosswise partitioning*
Compartment size: 182 x 366 mm



2 x QTW 130-0
4 x TWH 1

For containers in the ELB, LTF, LTB and MF ranges

2-way lengthwise partitioning*

Compartment size: 566 x 115 mm

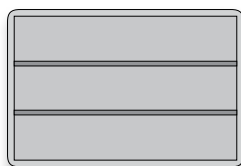

2x LTW 130-0
4x TWH 1

4-way crosswise partitioning*

Compartment size: 134 x 366 mm



3x QTW 130-0
6x TWH 1

4-way lengthwise partitioning*

Compartment size: 566 x 84 mm



3x LTW 130-0
6x TWH 1

4-way partitioning*

Compartment size: 278 x 178 mm



1x QTW 130-1
1x LTW 130-1
4x TWH 1

6-way crosswise partitioning*

Compartment size: 182 x 178 mm



2x QTW 130-1
1x LTW 130-2
6x TWH 1

6-way lengthwise partitioning

Compartment size: 278 x 115 mm

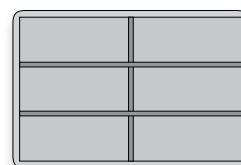

1x QTW 130-2
2x LTW 130-1
6x TWH 1

8-way crosswise partitioning*

Compartment size: 134 x 178 mm



3x QTW 130-1
1x LTW 130-3
8x TWH 1

8-way lengthwise partitioning

Compartment size: 278 x 84 mm

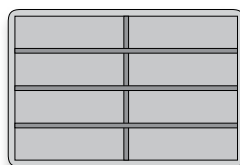

1x QTW 130-3
3x LTW 130-1
8x TWH 1

10-way crosswise partitioning**

Compartment size: 105 x 178 mm

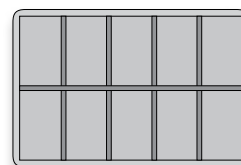

4x QTW 130-1
1x LTW 130-4
10x TWH 1

12-way crosswise partitioning

Compartment size: 134 x 115 mm



3x QTW 130-2
2x LTW 130-3
10x TWH 1

12-way lengthwise partitioning

Compartment size: 182 x 84 mm

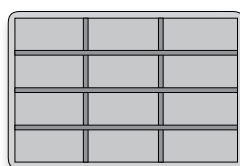

2x QTW 130-3
3x LTW 130-2
10x TWH 1

16-way partitioning

Compartment size: 134 x 84 mm



3x QTW 130-3
3x LTW 130-3
12x TWH 1

20-way partitioning**

Compartment size: 105 x 84 mm

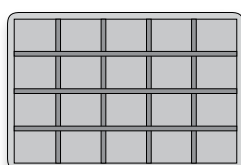

4x QTW 130-3
3x LTW 130-4
14x TWH 1

* Achievable with standard hole pattern

** Only possible with 130 mm high dividers

Dividers for basic dimensions 600 x 400 mm

Longitudinal dividers 130 mm

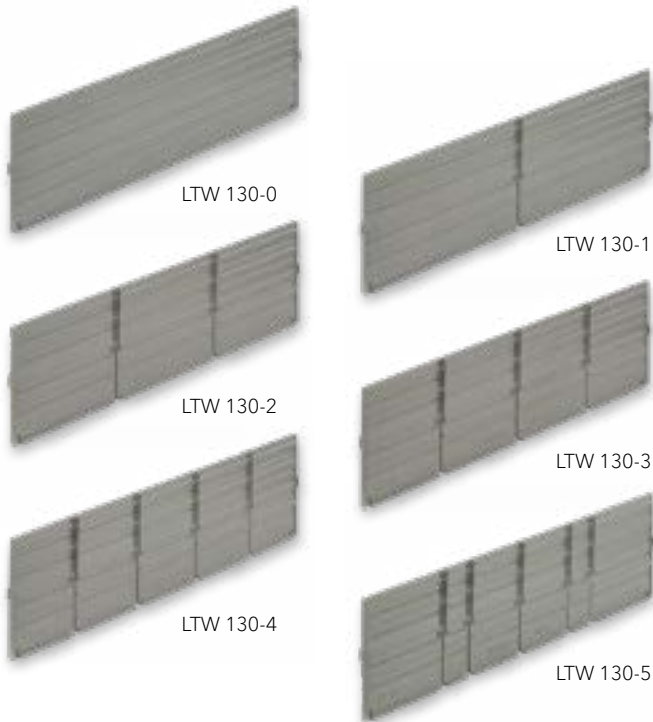

	LTW 130-0 PS	LTW 130-0og PS
For containers with	closed grips	open grips
Divider height	130 mm	130 mm
Number of slots	-	-
Colour	Grey	Grey
Order no.	187525*	187635*
	LTW 130-1 PS	LTW 130-1og PS
Number of slots	1 unit	1 unit
Colour	Grey	Grey
Order no.	187535*	187645*
	LTW 130-2 PS	LTW 130-2og PS
Number of slots	2 units	2 units
Colour	Grey	Grey
Order no.	187545*	187655*
	LTW 130-3 PS	LTW 130-3og PS
Number of slots	3 units	3 units
Colour	Grey	Grey
Order no.	187555*	187665*
	LTW 130-4 PS	LTW 130-4og PS
Number of slots	4 units	4 units
Colour	Grey	Grey
Order no.	187565*	187675*
	LTW 130-5 PS	LTW 130-5og PS
Number of slots	5 units	5 units
Colour	Grey	Grey
Order no.	187575*	187685*

Longitudinal dividers 180 mm

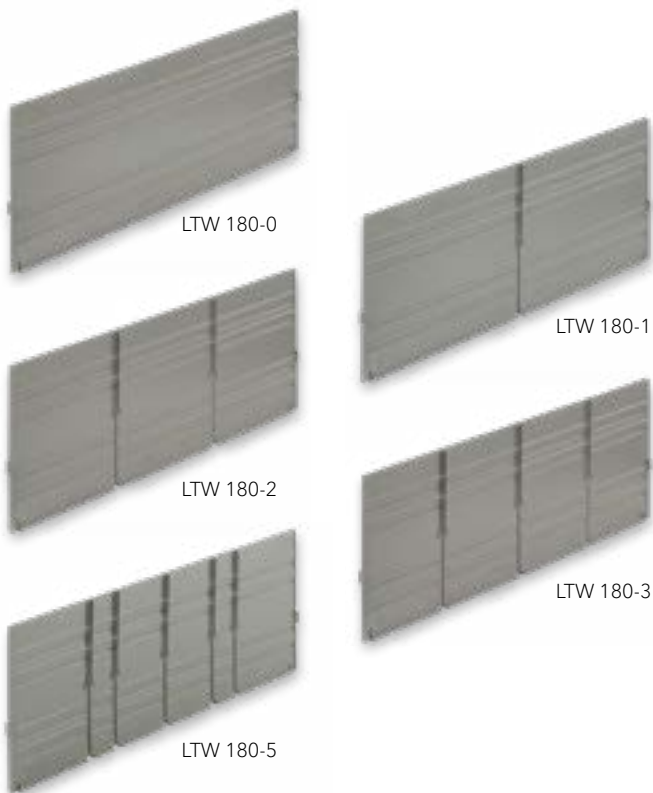

	LTW 180-0 PS	LTW 180-0og PS
For containers with	closed grips	open grips
Divider height	180 mm	180 mm
Number of slots	-	-
Colour	Grey	Grey
Order no.	187585*	187695*
	LTW 180-1 PS	LTW 180-1og PS
Number of slots	1 unit	1 unit
Colour	Grey	Grey
Order no.	187595*	187705*
	LTW 180-2 PS	LTW 180-2og PS
Number of slots	2 units	2 units
Colour	Grey	Grey
Order no.	187605*	187715*
	LTW 180-3 PS	LTW 180-3og PS
Number of slots	3 units	3 units
Colour	Grey	Grey
Order no.	187615*	187725*
	LTW 180-5 PS	LTW 180-5og PS
Number of slots	5 units	5 units
Colour	Grey	Grey
Order no.	187625*	187735*



Longitudinal dividers, "og" type, for containers with open grips - e.g. for LTB containers

For containers in the ELB, LTF, LTB and MF ranges

QTW 130-0 PS

Divider height 130 mm

Number of slots -

Colour Grey

Order no. 187745*

QTW 130-1 PS

Number of slots 1 unit

Colour Grey

Order no. 187755*

QTW 130-2 PS

Number of slots 2 units

Colour Grey

Order no. 187765*

QTW 130-3 PS

Number of slots 3 units

Colour Grey

Order no. 187775*

QTW 130-5 PS

Number of slots 5 units

Colour Grey

Order no. 187795*

Crosswise dividers 130 mm



QTW 180-0 PS

Divider height 180 mm

Number of slots -

Colour Grey

Order no. 187805*

QTW 180-1 PS

Number of slots 1 unit

Colour Grey

Order no. 187815*

QTW 180-2 PS

Number of slots 2 units

Colour Grey

Order no. 187825*

QTW 180-3 PS

Number of slots 3 units

Colour Grey

Order no. 187835*

QTW 180-5 PS

Number of slots 5 units

Colour Grey

Order no. 187845*

Crosswise dividers 180 mm



Insert boxes - efficiency and tidiness

Insert boxes are an ideal solution for organising and safely storing small components. In boxes, drawers and containers, our insert boxes ensure tidiness, optimum space utilisation and a clear overview.

These flexibly usable boxes withstand most oils, acids and alkalis, while the smooth interior walls are easy to clean.

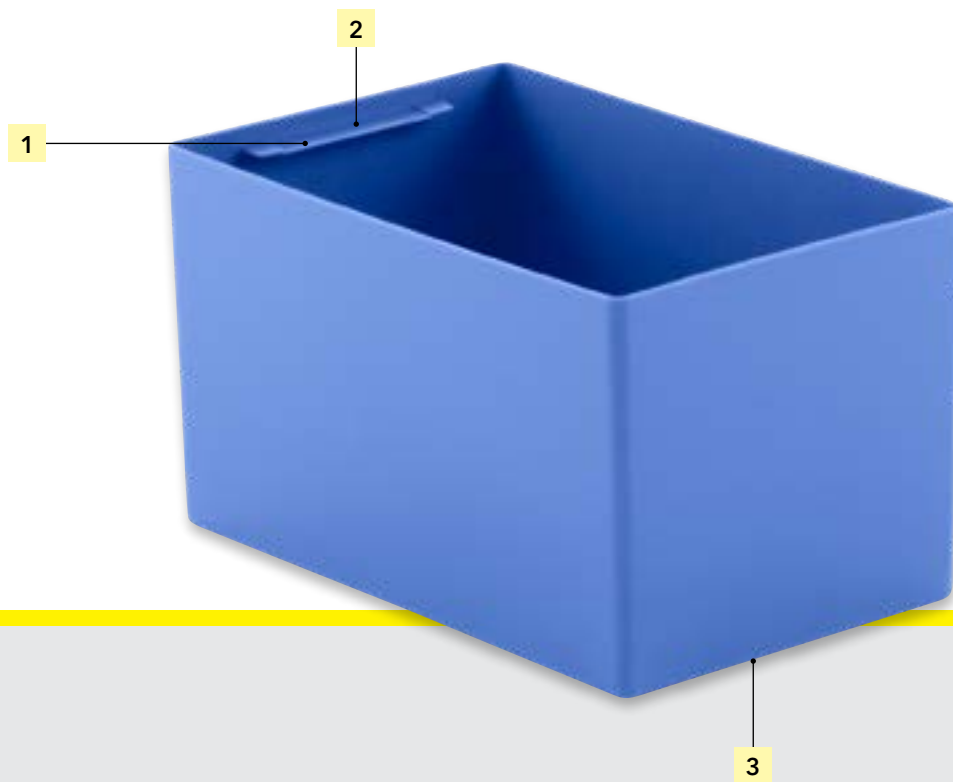

1| Tab
to facilitate removal



2| Tab
with barcode for content labelling

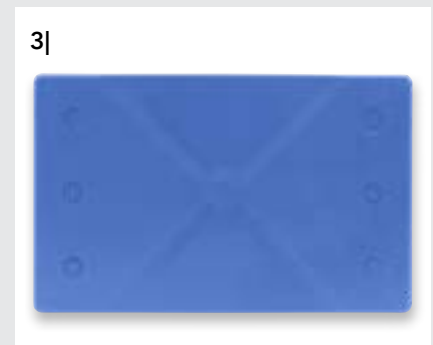

3| Base

Standard colours:





Key facts

- Small component organiser
- Maximum capacity utilisation of the container for products that do not need to be stored in large quantities

Typical customer applications

- In our containers, in drawers of cupboards and workbenches
- Efficient, smart availability of slow-moving items
- Assembly containers



Partitioning example
for basic dimensions 300 x 200 mm



Partitioning example
for basic dimensions 400 x 300 mm



Partitioning example
for basic dimensions 600 x 400 mm

For the EF and MF ranges

Basic dimensions 300 x 200 mm



EK 3021 PP	
External dimensions	157 x 127 x 80 mm
L x W x H	
Packaging unit	84 units
Colour	Blue
Order no.	1184
EK 3021 PPL conductive model	
Colour	Black, conductive
Order no.	1188

Partitioning examples



2x EK 3021

EK 4081 PP

External dimensions L x W x H	129 x 90 x 80 mm
Packaging unit	64 units
Colour	Blue
Order no.	1934

EK 4081 PPL conductive model

Colour	Black, conductive
Order no.	1938

EK 4041 PP

External dimensions L x W x H	179 x 129 x 80 mm
Packaging unit	48 units
Colour	Blue
Order no.	1924

EK 4041 PPL conductive model

Colour	Black, conductive
Order no.	1928

EK 4021 PP

External dimensions L x W x H	258 x 179 x 80 mm
Packaging unit	36 units
Colour	Blue
Order no.	1914

EK 4021 PPL conductive model

Colour	Black, conductive
Order no.	1918

Basic dimensions 400 x 300 mm



Partitioning examples



8 x EK 4081



4 x EK 4041



2 x EK 4021

For all stackable Euro containers

Basic dimensions 600 x 400 mm



EK 6161 PP	
External dimensions	140 x 90 x 80 mm
L x W x H	
Packaging unit	84 units
Colour	Blue
Order no.	4764
EK 6161 PPL conductive model	
Colour	Black, conductive
Order no.	4768



EK 6081 PP	
External dimensions	179 x 140 x 80 mm
L x W x H	
Packaging unit	48 units
Colour	Blue
Order no.	4754
EK 6081 PPL conductive model	
Colour	Black, conductive
Order no.	4758



EK 6082 PP	
External dimensions	179 x 140 x 150 mm
L x W x H	
Packaging unit	32 units
Colour	Blue
Order no.	79354
EK 6082 PPL conductive model	
Colour	Black, conductive
Order no.	79358*

Partitioning examples



16 x EK 6161



8 x EK 6081



8 x EK 6082

EK 6041 PP

External dimensions L x W x H	279 x 179 x 80 mm
Packaging unit	36 units
Colour	Blue
Order no.	4734

EK 6041 PPL conductive model

Colour	Black, conductive
Order no.	4738

EK 6042 PP

External dimensions L x W x H	279 x 179 x 150 mm
Packaging unit	18 units
Colour	Blue
Order no.	4724

EK 6042 PPL conductive model

Colour	Black, conductive
Order no.	4728

EK 6021 Q PP

External dimensions L x W x H	358 x 279 x 80 mm
Packaging unit	18 units
Colour	Blue
Order no.	79364

EK 6021 Q PPL conductive model

Colour	Black, conductive
Order no.	79368

Basic dimensions 600 x 400 mm



Partitioning examples



4 x EK 6041



4 x EK 6042



2 x EK 6021 Q

For all stackable Euro containers

Basic dimensions 600 x 400 mm



EK 6022 Q PP

External dimensions L x W x H	358 x 279 x 150 mm
Packaging unit	12 units
Colour	Blue
Order no.	4774

EK 6022 Q PPL conductive model

Colour	Black, conductive
Order no.	4778

EK 6041 L PP

External dimensions L x W x H	558 x 90 x 80 mm
Packaging unit	48 units
Colour	Blue
Order no.	4744

EK 6041 L PPL conductive model

Colour	Black, conductive
Order no.	4748*

EK 6022 L PP

External dimensions L x W x H	558 x 179 x 150 mm
Packaging unit	12 units
Colour	Blue
Order no.	4714

EK 6022 L PPL conductive model

Colour	Black, conductive
Order no.	4718

Partitioning examples

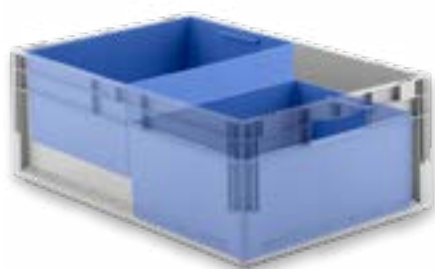

2 x EK 6022 Q



4 x EK 6041 L



2 x EK 6022 L

EK 6021 PP

External dimensions L x W x H	558 x 179 x 80 mm
Packaging unit	24 units
Colour	Blue
Order no.	1944

EK 6021 PPL conductive model

Colour	Black, conductive
Order no.	1948

EK 6023 L PP

External dimensions L x W x H	558 x 179 x 215 mm
Packaging unit	24 units
Colour	Blue
Order no.	4784*

EK 6023 L PPL conductive model

Colour	Black, conductive
Order no.	4788*

Basic dimensions 600 x 400 mm



Partitioning examples

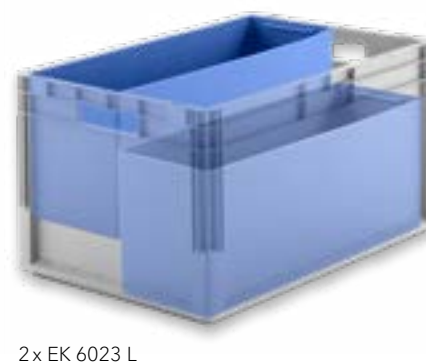

* = Article on request

For the EF range

Basic dimensions 600 x 400 mm



EK 110-N PS

External dimensions L x W x H	68 x 87 x 96 mm
Packaging unit	96 units
Colour	Blue
Order no.	4704

EK 110-N PPL conductive model

Colour	Black, conductive
Order no.	4708



EK 111-N PS

External dimensions L x W x H	137 x 87 x 96 mm
Packaging unit	48 units
Colour	Blue
Order no.	4364

EK 111-N PPL conductive model

Colour	Black, conductive
Order no.	4368



EK 111 PS

External dimensions L x W x H	137 x 87 x 110 mm
Packaging unit	48 units
Colour	Blue
Order no.	22644

EK 111 PPL conductive model

Colour	Black, conductive
Order no.	22648

Partitioning examples



32 x EK 110-N



16 x EK 111-N



16 x EK 111

EK 112-N PS

External dimensions L x W x H	174 x 137 x 96 mm
Packaging unit	40 units
Colour	Blue
Order no.	4374

EK 112-N PPL conductive model

Colour	Black, conductive
Order no.	4378

EK 112 PS

External dimensions L x W x H	174 x 137 x 110 mm
Packaging unit	40 units
Colour	Blue
Order no.	22634

EK 112 PPL conductive model

Colour	Black, conductive
Order no.	22638

EK 113-N PS

External dimensions L x W x H	274 x 174 x 96 mm
Packaging unit	36 units
Colour	Blue
Order no.	4384

EK 113-N PPL conductive model

Colour	Black, conductive
Order no.	4388

Basic dimensions 600 x 400 mm



Partitioning examples



8x EK 112-N



8x EK 112



4x EK 113-N

For the EF range

Basic dimensions 600 x 400 mm



EK 113 PS

External dimensions	274 x 174 x 110 mm
L x W x H	
Packaging unit	36 units
Colour	Blue
Order no.	22624

EK 113 PPL conductive model

Colour	Black, conductive
Order no.	22628

EK 14-4 PS

External dimensions	355 x 184 x 80 mm
L x W x H	
Packaging unit	48 units
Colour	Blue
Order no.	7184

EK 14-4 PPL conductive model

Colour	Black, conductive
Order no.	7188

EK 114-N PS

External dimensions	550 x 87 x 96 mm
L x W x H	
Packaging unit	36 units
Colour	Blue
Order no.	4394*

EK 114-N PPL conductive model

Colour	Black, conductive
Order no.	4398*

Partitioning examples



4 x EK 113



2 x EK 113, 2 x EK 112
and 4 x EK 111



4 x EK 114-N

EK 114 PS

External dimensions L x W x H	550 x 87 x 110 mm
Packaging unit	36 units
Colour	Blue
Order no.	22614

EK 114 PPL conductive model

Colour	Black, conductive
Order no.	22618

EK 115-N PS

External dimensions L x W x H	550 x 174 x 96 mm
Packaging unit	18 units
Colour	Blue
Order no.	4404

EK 115-N PPL conductive model

Colour	Black, conductive
Order no.	4408

EK 115 PS

External dimensions L x W x H	550 x 174 x 110 mm
Packaging unit	18 units
Colour	Blue
Order no.	22604

EK 115 PPL conductive model

Colour	Black, conductive
Order no.	22608

Basic dimensions 600 x 400 mm



Partitioning examples



4 x EK 114



2 x EK 115-N



2 x EK 115

Containers for semi- and fully automated systems

- **ELB Light automation containers** from page **C2**
- **LTF Medium automation containers** from page **C10**
- **LTB Heavy automation containers** from page **C16**
- **Dividers** from page **C30**
- **Insert boxes** from page **C34**
- **Trays** from page **C40**

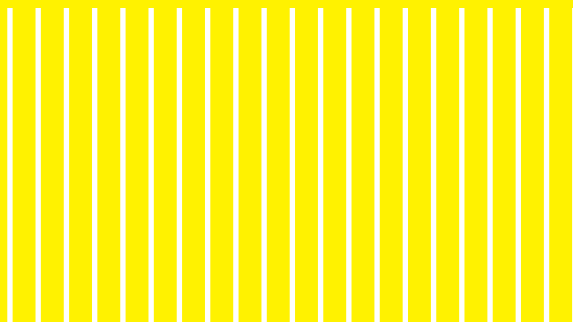

ELB Light automation containers

Our latest automation container range, the ELB, is successfully used in semi- and fully automated systems for applications with loads in the light weight range.

The ELB impresses with an extremely smart and minimalist design. By focusing on the essentials, we firstly achieve a very low container tare weight, which is a major advantage in modern warehouses and distribution centres, because less container weight means that more saleable goods can be stored. Secondly, our ELB is only reinforced where an automation container needs to be strong. The ELB is

an automation container that has been reduced to the essentials, which is clearly reflected in the price to our customers.

We offer you our consulting services for your project. The sooner you contact us, the better this will be for you, too, because our experienced specialists for automation containers will be happy to advise you in detail about the advantages and disadvantages, potential savings, environmental aspects and any hidden costs.

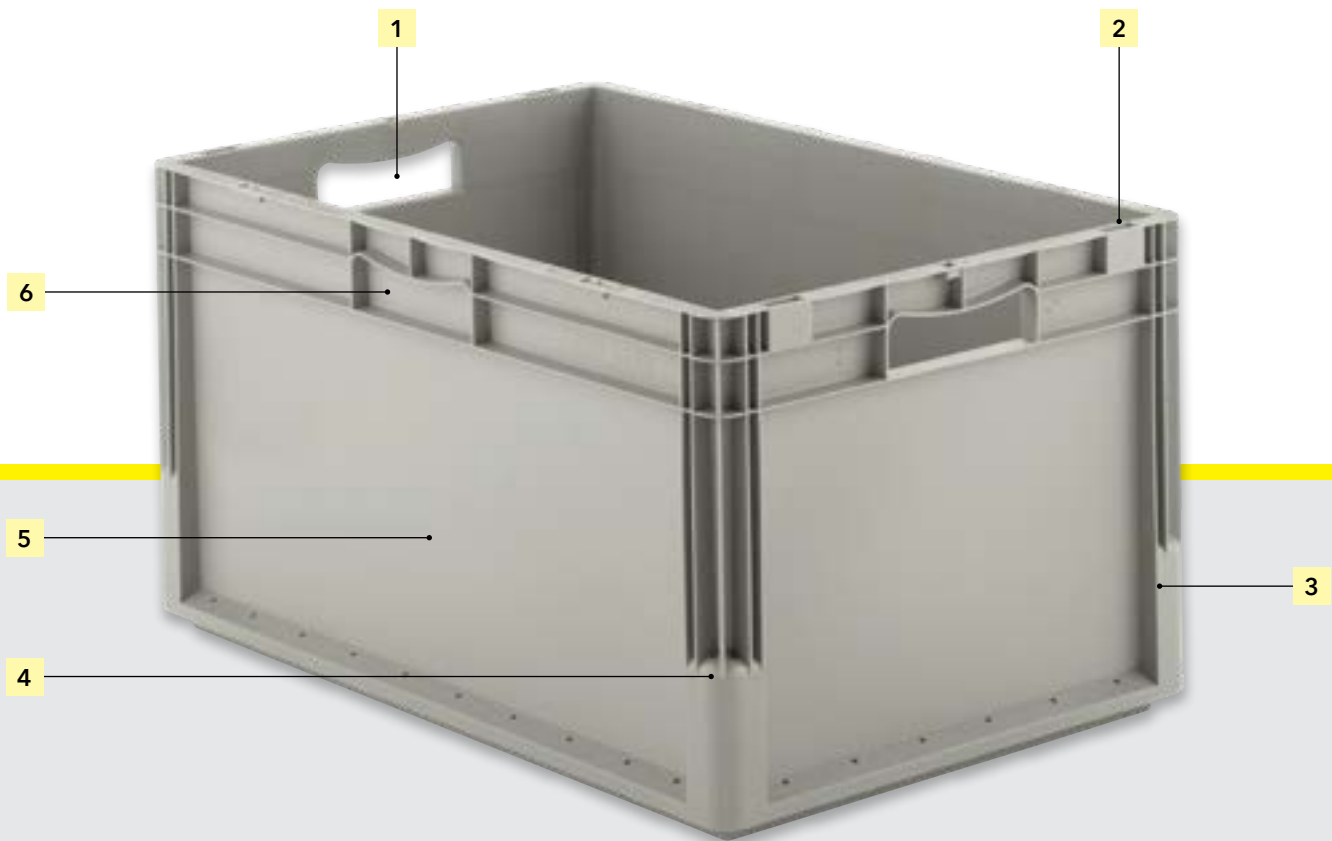

1| Comfortable, ergonomic hand hole*
on both short sides for semi-automated handling

2| Lifting slots
for automated lifting devices & handling equipment

3| Optimised rib structure
reduces the need for double walls

4| Well-designed, strong corners and corner profile design
constructed to be strong in the places that are important in automated systems

5| Smart, minimalist design
with a focus on the essentials for automated use

6| Grip on long side
rarely relevant in automated warehouses, therefore optimally reduced to a grip bar



Key facts

- On the way to becoming a bestseller
- More than 10 years of success on the market in numerous different installations
- Low container tare weight
- Smooth base = low-noise operation
- Lifting slots
- Ergonomically shaped grips
- Reduced, smart design
- Very good value for money

Typical customer applications

- Loads from 10 to 25 kg
- Intralogistics containers in semi- and fully automated warehouses
- Order picking containers with our flexible divider system

Water drainage options with fire classification according to VDS or FM-Global, conveyor technology, flow racks, carousel systems, order picking, shuttle systems... talk to us about your project. Our specialist staff will be happy to advise you.

Smooth standard base
(max. load 20 kg)



Ribbed base VB01
(max. load 35 kg)



Reinforced welded base VS01
(max. load 50 kg)



Standard colour:



Standard models

400 x 300 x 120 mm



ELB 4120 PP

External dimensions L x W x H	399 x 299 x 120 mm
-------------------------------	--------------------

Internal dimensions L x W x H	356 x 256 x 115 mm
-------------------------------	--------------------

Usable height when stacked	100 mm
----------------------------	--------

Capacity	10.9 litres
----------	-------------

Load (max.)	20 kg
-------------	-------

Colour	Grey
--------	------

Order no.	56505
-----------	-------

ELB 4120 VB01 PP with ribbed base

Internal dimensions L x W x H	359 x 259 x 103 mm
-------------------------------	--------------------

Usable height when stacked	89 mm
----------------------------	-------

Capacity	9.9 litres
----------	------------

Load (max.)	35 kg
-------------	-------

Colour	Grey
--------	------

Order no.	56515*
-----------	--------

ELB 4120 VS01 PP with reinforced welded base

Internal dimensions L x W x H	356 x 259 x 103 mm
-------------------------------	--------------------

Usable height when stacked	89 mm
----------------------------	-------

Load (max.)	50 kg
-------------	-------

Colour	Grey
--------	------

Order no.	56525*
-----------	--------

400 x 300 x 220 mm



ELB 4220 PP

External dimensions L x W x H	399 x 299 x 220 mm
-------------------------------	--------------------

Internal dimensions L x W x H	356 x 256 x 215 mm
-------------------------------	--------------------

Usable height when stacked	200 mm
----------------------------	--------

Capacity	20.4 litres
----------	-------------

Load (max.)	20 kg
-------------	-------

Colour	Grey
--------	------

Order no.	56535
-----------	-------

ELB 4220 VB01 PP with ribbed base

Internal dimensions L x W x H	359 x 259 x 203 mm
-------------------------------	--------------------

Usable height when stacked	188 mm
----------------------------	--------

Capacity	19.5 litres
----------	-------------

Load (max.)	35 kg
-------------	-------

Colour	Grey
--------	------

Order no.	56545*
-----------	--------

ELB 4220 VS01 PP with reinforced welded base

Internal dimensions L x W x H	359 x 258 x 203 mm
-------------------------------	--------------------

Usable height when stacked	188 mm
----------------------------	--------

Load (max.)	50 kg
-------------	-------

Colour	Grey
--------	------

Order no.	56555*
-----------	--------

ELB 6120 PP

External dimensions L x W x H	599 x 399 x 120 mm
Internal dimensions L x W x H	555 x 355 x 115 mm
Usable height when stacked	100 mm
Capacity	23.3 litres
Load (max.)	20 kg
Colour	Grey
Order no.	56565

ELB 6120 VB01 PP with ribbed base

Internal dimensions L x W x H	560 x 360 x 103 mm
Usable height when stacked	89 mm
Capacity	21.2 litres
Load (max.)	35 kg
Colour	Grey
Order no.	56575*

ELB 6120 VS01 PP with reinforced welded base

Internal dimensions L x W x H	560 x 360 x 103 mm
Usable height when stacked	89 mm
Load (max.)	50 kg
Colour	Grey
Order no.	56585*

600 x 400 x 120 mm



ELB 6220 PP

External dimensions L x W x H	599 x 399 x 220 mm
Internal dimensions L x W x H	555 x 355 x 215 mm
Usable height when stacked	200 mm
Capacity	43.7 litres
Load (max.)	20 kg
Colour	Grey
Order no.	56595

ELB 6220 VB01 PP with ribbed base

Internal dimensions L x W x H	560 x 360 x 203 mm
Usable height when stacked	188 mm
Capacity	41.7 litres
Load (max.)	35 kg
Colour	Grey
Order no.	56605*

ELB 6220 VS01 PP with reinforced welded base

Internal dimensions L x W x H	560 x 360 x 203 mm
Usable height when stacked	188 mm
Load (max.)	50 kg
Colour	Grey
Order no.	56615*

600 x 400 x 220 mm



ELB 6320 PP

External dimensions L x W x H	599 x 399 x 320 mm
Internal dimensions L x W x H	555 x 355 x 314 mm
Usable height when stacked	300 mm
Capacity	64.0 litres
Load (max.)	20 kg
Colour	Grey
Order no.	56625

ELB 6320 VB01 PP with ribbed base

Internal dimensions L x W x H	560 x 360 x 303 mm
Usable height when stacked	288 mm
Capacity	62.3 litres
Load (max.)	35 kg
Colour	Grey
Order no.	56635*

ELB 6320 VS01 PP with reinforced welded base

Internal dimensions L x W x H	560 x 360 x 303 mm
Usable height when stacked	288 mm
Load (max.)	50 kg
Colour	Grey
Order no.	56645*

600 x 400 x 320 mm



* = Article on request

With two-part hinged lids

400 x 300 x 137 mm



ELB-DH 4120 PP

External dimensions L x W x H 399 x 299 x 137 mm

Internal dimensions L x W x H 356 x 256 x 115 mm

Usable height when stacked 100 mm

Capacity 10.9 litres

Load (max.) 20 kg

Colour Grey

Order no. 56005

ELB-DH 4120 VB01 PP with ribbed base

Internal dimensions L x W x H 359 x 259 x 103 mm

Usable height when stacked 89 mm

Capacity 9.9 litres

Load (max.) 35 kg

Colour Grey

Order no. 56905*

ELB-DH 4120 VS01 PP with reinforced welded base

Internal dimensions L x W x H 356 x 259 x 103 mm

Usable height when stacked 89 mm

Load (max.) 50 kg

Colour Grey

Order no. 56055*

400 x 300 x 237 mm



ELB-DH 4220 PP

External dimensions L x W x H 399 x 299 x 237 mm

Internal dimensions L x W x H 356 x 256 x 215 mm

Usable height when stacked 200 mm

Capacity 20.4 litres

Load (max.) 20 kg

Colour Grey

Order no. 56015

ELB-DH 4220 VB01 PP with ribbed base

Internal dimensions L x W x H 359 x 259 x 203 mm

Usable height when stacked 188 mm

Capacity 19.5 litres

Load (max.) 35 kg

Colour Grey

Order no. 56915*

ELB-DH 4220 VS01 PP with reinforced welded base

Internal dimensions L x W x H 359 x 258 x 203 mm

Usable height when stacked 188 mm

Load (max.) 50 kg

Colour Grey

Order no. 56065*

ELB-DH 6120 PP

External dimensions L x W x H	599 x 399 x 137 mm
Internal dimensions L x W x H	555 x 355 x 115 mm
Usable height when stacked	100 mm
Capacity	23.3 litres
Load (max.)	20 kg
Colour	Grey
Order no.	56025*

ELB-DH 6120 VB01 PP with ribbed base

Internal dimensions L x W x H	560 x 360 x 103 mm
Usable height when stacked	89 mm
Capacity	21.2 litres
Load (max.)	35 kg
Colour	Grey
Order no.	56925*

ELB-DH 6120 VS01 PP with reinforced welded base

Internal dimensions L x W x H	560 x 360 x 103 mm
Usable height when stacked	89 mm
Load (max.)	50 kg
Colour	Grey
Order no.	56075*

600 x 400 x 137 mm

**ELB-DH 6220 PP**

External dimensions L x W x H	599 x 399 x 237 mm
Internal dimensions L x W x H	555 x 355 x 215 mm
Usable height when stacked	200 mm
Capacity	43.7 litres
Load (max.)	20 kg
Colour	Grey
Order no.	56035

ELB-DH 6220 VB01 PP with ribbed base

Internal dimensions L x W x H	560 x 360 x 203 mm
Usable height when stacked	188 mm
Capacity	41.7 litres
Load (max.)	35 kg
Colour	Grey
Order no.	56935*

ELB-DH 6220 VS01 PP with reinforced welded base

Internal dimensions L x W x H	560 x 360 x 203 mm
Usable height when stacked	188 mm
Load (max.)	50 kg
Colour	Grey
Order no.	56085*

600 x 400 x 237 mm

**ELB-DH 6320 PP**

External dimensions L x W x H	599 x 399 x 337 mm
Internal dimensions L x W x H	555 x 355 x 314 mm
Usable height when stacked	300 mm
Capacity	64.0 litres
Load (max.)	20 kg
Colour	Grey
Order no.	56045

ELB-DH 6320 VB01 PP with ribbed base

Internal dimensions L x W x H	560 x 360 x 303 mm
Usable height when stacked	288 mm
Capacity	62.3 litres
Load (max.)	35 kg
Colour	Grey
Order no.	56945*

ELB-DH 6320 VS01 PP with reinforced welded base

Internal dimensions L x W x H	560 x 360 x 303 mm
Usable height when stacked	288 mm
Load (max.)	50 kg
Colour	Grey
Order no.	56095*

600 x 400 x 337 mm



Lids and pallet covers

Basic dimensions 400 x 300 mm



LTB-D 43 PP drop-on lid

Colour	Grey
Order no.	75905

LTB-D 43 S PP with hinges*

Colour	Grey
Order no.	76205

* including two lid hinges (lid clips available on request)

Basic dimensions 600 x 400 mm



LTB-D 64 PP drop-on lid

Colour	Grey
Order no.	75915

LTB-D 64 S PP with hinges*

Colour	Grey
Order no.	76215

* including two lid hinges (lid clips available on request)

Lid clips

Colour	White
Order no.	99237



Drop-on lid



Lid with hinges



Lid clip (on request)

Basic dimensions 800 x 600 mm



ADH 86 PP pallet cover with banding slots and indentations for dollies

External dimensions L x W x H	814 x 614 x 44 mm
Height when stacked	30 mm
Colour	Black
Order no.	93628

Pallet covers and accessories

A 1208 PP pallet cover

Colour	Blue
Order no.	39704

A 1208-1 PP pallet cover

Colour	Blue
Order no.	35614

Basic dimensions 1200 x 800 mm

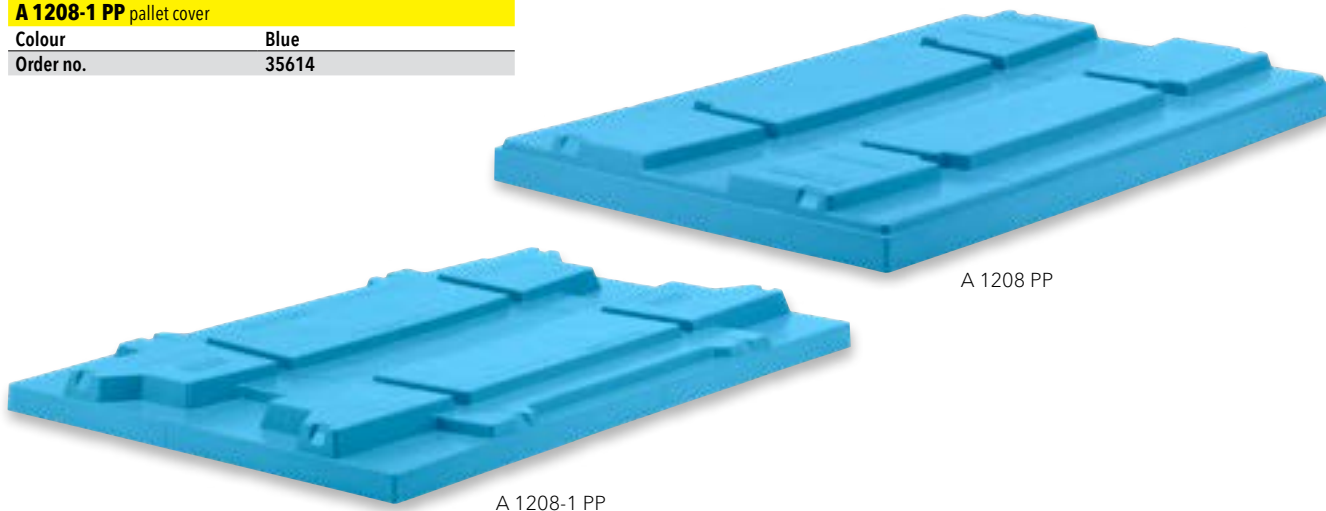

Our expertise: Plastic containers

Storage & transport containers for manual handling

Containers for semi- and fully automated systems

GV-MF PP

Packaging unit	1 unit	
Colour	Blue	Grey
Order no.	39794	39795

Grip closure

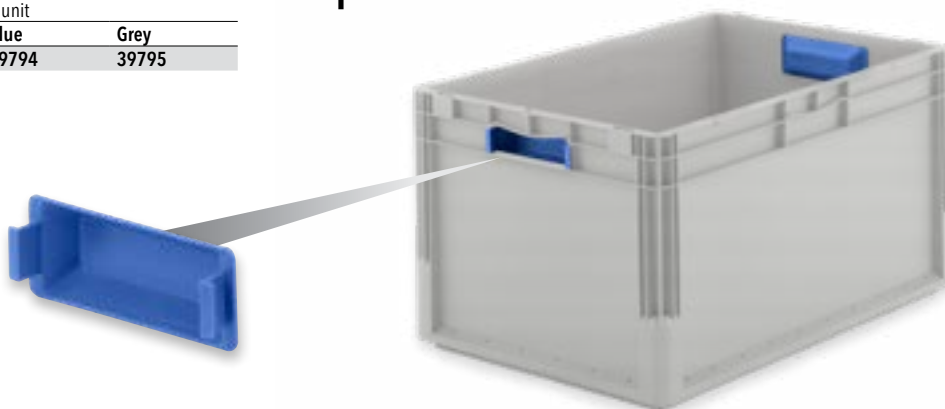

Space-saving containers

ELB-E

Packaging unit	1 unit
Order no.	16020

Label holder

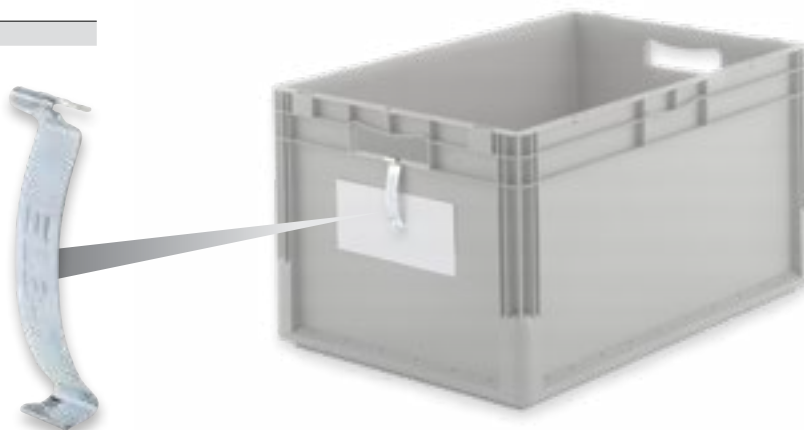

Containers for storing small parts

Industry solutions for the automotive industry

LTF Medium automation containers

A bestseller for decades, our LTF automation container range is a proven container solution for automated applications in the medium weight range. The words robust and economical best describe the LTF. The LTF range is particularly suitable for customers who are currently still working manually but would like to automate in the medium term.

A key success factor of the LTF is without question its running frame base. We have developed a combination of two popular base types - smooth base and ribbed base - to create a perfect base combination. Smooth outer circumferential rim and ribbed base in the centre

= dimensional stability, best tolerance values, low-noise running, top running properties, less wear, optimum conveying speed.

Another success factor is its cost-effectiveness, because the LTF has been optimised precisely for loads in the medium range.

Let's talk about your project. Our experienced specialists for automation containers will be happy to advise you in detail about the advantages and disadvantages, potential savings, environmental aspects and any hidden costs in relation to your project.

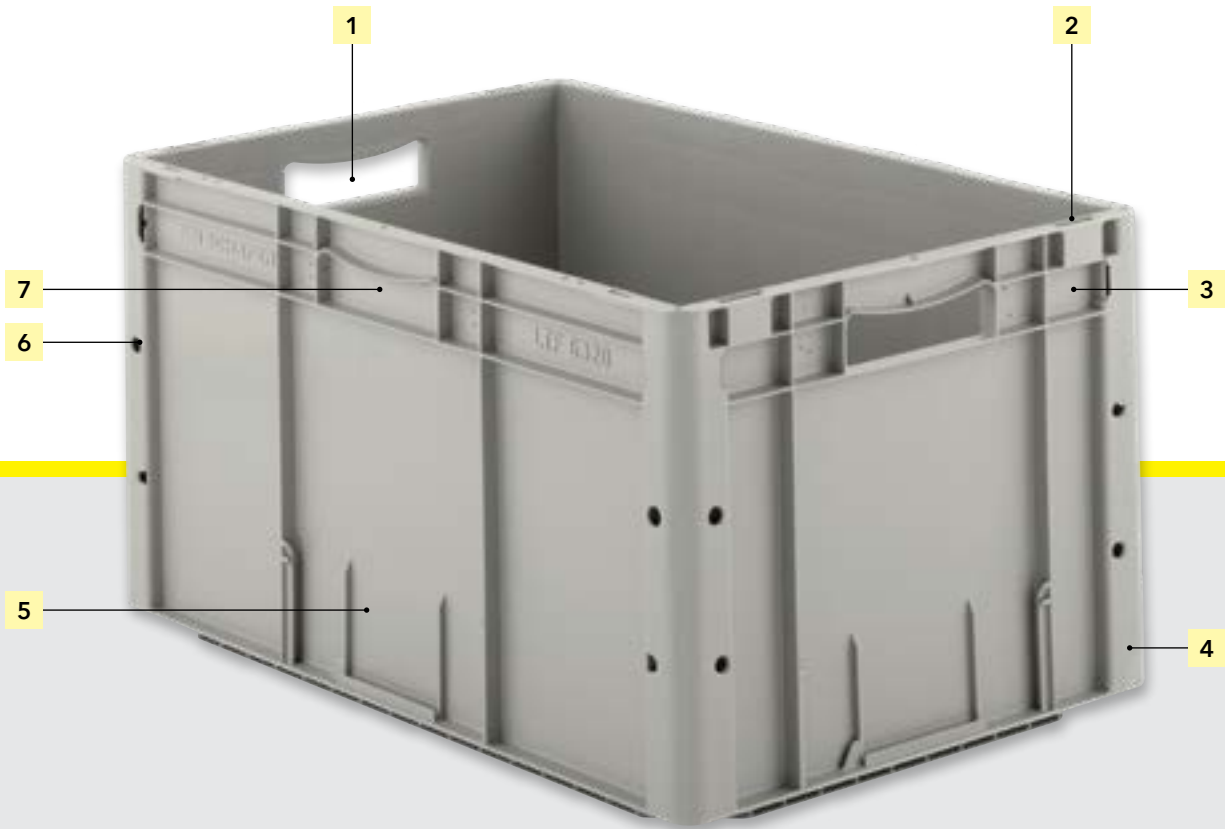

1| Ergonomic hand holes on short sides

also available with closed grips

2| Lifting slots

for automated lifting devices

3| Optimised rib structure

designed for medium loads

4| Reinforced, continuous double-walled corners

for low tolerances, dimensional stability and reliable approach position, for example for system grippers

5| Label holders on all sides

6| 4 alignment holes per corner

for centring handling units and for safe handling of the container in automatic systems

7| Grip on long side

also available with open grips



Key facts

- Bestseller, our most frequently sold automation container range worldwide for over two decades
- Robust container design
- Dimensionally stable thanks to strong base and corner column design
- For multifunctional use in internal and external material flows
- The best choice as an entry-level container when switching from manual to automated handling
- Ergonomically shaped grips for human interaction
- Long service life and high cost-effectiveness

Typical customer applications

- Loads from 30 to 50 kg
- Intralogistics containers in semi- and fully automated warehouses
- Internal and external reusable transport containers
- Order picking containers with our flexible divider system

Water drainage options with fire classification according to VDS or FM-Global, conveyor technology, flow racks, automated small-parts warehouses, carousel systems, order picking, shuttle systems... let's talk about your project. Our specialist staff will be happy to advise you.

Standard base
(max. load 30 kg)

Reinforced, diagonally ribbed base VB02
(max. load 50 kg)

Reinforced welded base VS01
(max. load 70 kg)



Standard colours:



Standard models

600 x 400 x 120 mm



LTF 6120 PP

External dimensions L x W x H	594 x 396 x 120 mm	
Internal dimensions L x W x H	564 x 366 x 102 mm	
Usable height when stacked	87 mm	
Capacity	21.0 litres	
Load (max.)	30 kg	
Colour	Blue	Grey
Order no.	35764	35765

LTF 6120 VB02 PP with ribbed base

Internal dimensions L x W x H	564 x 366 x 102 mm	
Usable height when stacked	87 mm	
Capacity	21.0 litres	
Load (max.)	50 kg	
Colour	Blue	Grey
Order no.	86094*	86095*

LTF 6120 VS01 PP with reinforced welded base

Internal dimensions L x W x H	564 x 366 x 102 mm	
Usable height when stacked	87 mm	
Capacity	21.0 litres	
Load (max.)	70 kg	
Colour	Blue	Grey
Order no.	86104*	86105*

600 x 400 x 220 mm



LTF 6220 PP

External dimensions L x W x H	594 x 396 x 220 mm	
Internal dimensions L x W x H	564 x 366 x 202 mm	
Usable height when stacked	187 mm	
Capacity	42.0 litres	
Load (max.)	30 kg	
Colour	Blue	Grey
Order no.	35724	35725

LTF 6220 VB02 PP with ribbed base

Internal dimensions L x W x H	564 x 366 x 202 mm	
Usable height when stacked	187 mm	
Capacity	42.0 litres	
Load (max.)	50 kg	
Colour	Blue	Grey
Order no.	86124*	86125*

LTF 6220 VS01 PP with reinforced welded base

Internal dimensions L x W x H	564 x 366 x 202 mm	
Usable height when stacked	187 mm	
Capacity	42.0 litres	
Load (max.)	70 kg	
Colour	Blue	Grey
Order no.	86134*	86135*

LTF 6280 PP

External dimensions L x W x H	594 x 396 x 280 mm	
Internal dimensions L x W x H	564 x 366 x 262 mm	
Usable height when stacked	247 mm	
Capacity	53.8 litres	
Load (max.)	30 kg	
Colour	Blue	Grey
Order no.	35704	35705

LTF 6280 VB02 PP with ribbed base

Internal dimensions L x W x H	564 x 366 x 262 mm	
Usable height when stacked	247 mm	
Capacity	53.8 litres	
Load (max.)	50 kg	
Colour	Blue	Grey
Order no.	86154*	86155*

LTF 6280 VS01 PP with reinforced welded base

Internal dimensions L x W x H	564 x 366 x 262 mm	
Usable height when stacked	247 mm	
Capacity	53.8 litres	
Load (max.)	70 kg	
Colour	Blue	Grey
Order no.	86164*	86165*

600 x 400 x 280 mm

**LTF 6320 PP**

External dimensions L x W x H	594 x 396 x 320 mm	
Internal dimensions L x W x H	564 x 366 x 302 mm	
Usable height when stacked	287 mm	
Capacity	62.7 litres	
Load (max.)	30 kg	
Colour	Blue	Grey
Order no.	35734	35735

LTF 6320 VB02 PP with ribbed base

Internal dimensions L x W x H	564 x 366 x 302 mm	
Usable height when stacked	287 mm	
Capacity	62.7 litres	
Load (max.)	50 kg	
Colour	Blue	Grey
Order no.	86184*	86185*

LTF 6320 VS01 PP with reinforced welded base

Internal dimensions L x W x H	564 x 366 x 302 mm	
Usable height when stacked	287 mm	
Capacity	62.7 litres	
Load (max.)	70 kg	
Colour	Blue	Grey
Order no.	86194*	86195*

600 x 400 x 320 mm



Special LTF container and lid

600 x 400 x 320 mm



LTF 6320 B01 PP one short side semi open

External dimensions L x W x H	594 x 396 x 320 mm	
Internal dimensions L x W x H	564 x 366 x 302 mm	
Usable height when stacked	287 mm	
End wall opening W x H	275 x 140 mm	
Capacity	62.7 litres	
Load (max.)	30 kg	
Colour	Blue	Grey
Order no.	35694*	35695*

SK 64152-1 PP dust flap

Colour	Translucent	
Order no.	93922*	

Basic dimensions 600 x 400 mm

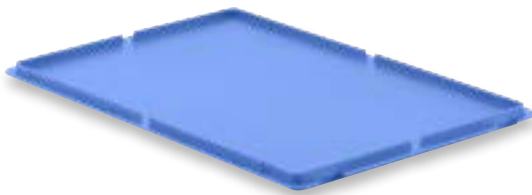

MF-D 64 PP drop-on lid with banding slots on all sides

Colour	Blue	Grey
Order no.	39744	39745

MF-D 64-H PP with hooks**

Colour	Blue	Grey
Order no.	39754	39755

MF-D 64-S PP with hinges

Colour	Blue	Grey
Order no.	39874	39875

MF-D 64-SF PP factory-fitted lid

Colour	Blue	Grey
Order no.	39764*	39765*

** Lid clips available on request

Lid clips

Colour	White
Order no.	99227



Lid with hooks



Hinged lid with reinforcing ring, assembled



Lid clip (on request)

Pallet covers and accessories

A 1208 PP pallet cover

Colour	Blue
Order no.	39704

A 1208-1 PP pallet cover

Colour	Blue
Order no.	35614

Basic dimensions 1200 x 800 mm

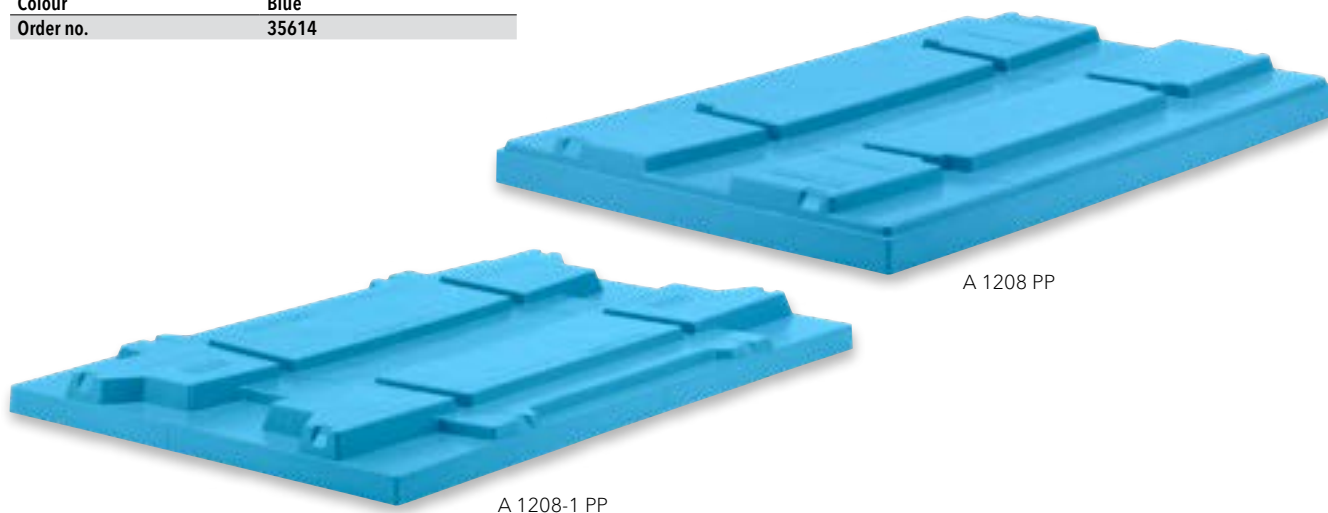

GV-MF PP

Packaging unit	1 unit	
Colour	Blue	Grey
Order no.	39794	39795

GV-MF 3 PP smooth model

Packaging unit	1 unit	
Colour	Blue	Grey
Order no.	22374	22385

Other colours on request

Grip closure

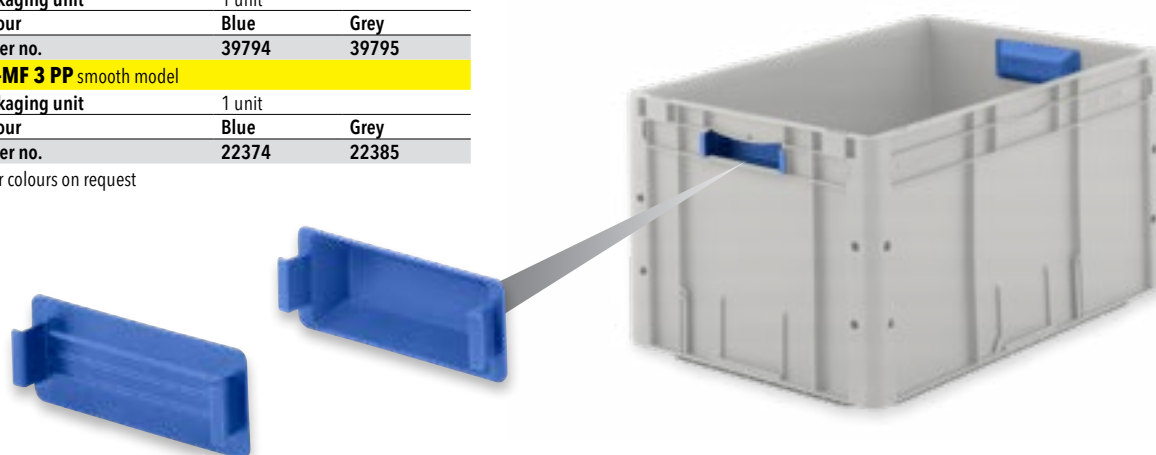

LTF-E

Packaging unit	1 unit
Order no.	16020

Label holder



LTB Heavy automation containers

Our dream team for over 2 decades: our LTB automation containers in conjunction with automated systems for heavy loads. The LTB Automation reliably does exactly what we developed it for. It plays a key role in ensuring that automated processes can run optimally worldwide. This is made possible by its extremely high dimensional stability, its low tolerance values and its outstanding quality and service life.

The LTB has been so comprehensively reinforced and designed by our most experienced developers that the enormous static and dynamic forces that act on the

container with a load of 70 kg, e.g. in the case of long-term storage on angle profiles in an automated small-parts warehouse, fast conveying and lorry transport, simply make our LTB automation container shine - 365 days a year for decades.

If you have a project involving heavy products or loads, please contact us. We will be happy to advise you in detail about the advantages and disadvantages, potential savings, environmental aspects and any hidden costs related to your project.



1| Particularly easy-to-grasp, wide, ergonomic grips on the short sides
optionally also available closed

2| Lifting slots
for automated lifting devices

3| Double and extra-wide corner column design
for reliable and safe storage, conveying and transport of heavy loads

4| 4 alignment holes per corner
for centring the container and for fast, safe interaction between the container and the automated system

5| Label holders on all sides

6| Closed grips on the long sides

7| All-round, double-walled rim
for dimensional stability with heavy loads



Key facts

- Our LTB and automatic system with heavy contents = dream team
- This combination makes a significant contribution to optimised automation and a smoothly running process
- Double-reinforced rim on all sides
- Double and extra-wide corner column design
- Particularly easy-to-grasp ergonomic grips
- Designed for use by handling devices
- Long service life and high cost-effectiveness

Typical customer applications

- Loads from 50 to 70 kg
- Also more than 100 kg (please consult our specialist staff for advice)
- Intralogistics container in semi- and fully automated warehouses
- Internal and external circulation transport containers
- Order picking containers with our flexible divider system

Water drainage options with fire classification according to VDS or FM-Global, conveyor technology, flow racks, automated small-parts warehouses, carousel systems, order picking, shuttle systems... let's talk about your project. Our specialist staff will be happy to advise you.

Smooth standard base GL
(max. load 25 kg)



Reinforced base VB
(max. load 50 kg)



Reinforced welded base VS01/05
(max. load 70 kg)



Standard colours:



Standard models

400 x 300 x 120 mm



LTB 4120 PP with reinforced base

External dimensions L x W x H	399 x 299 x 120 mm	
Internal dimensions L x W x H	367 x 267 x 103 mm	
Usable height when stacked	88 mm	
Capacity	10.0 litres	
Load (max.)	50 kg	
Colour	Blue	Grey
Order no.	75704	75705

LTF 4120 VS01 PP with reinforced welded base

Internal dimensions L x W x H	367 x 267 x 103 mm	
Usable height when stacked	88 mm	
Load (max.)	70 kg	
Colour	Blue	Grey
Order no.	79264*	79265*

400 x 300 x 220 mm



LTB 4220 PP with reinforced base

External dimensions L x W x H	399 x 299 x 220 mm	
Internal dimensions L x W x H	367 x 267 x 203 mm	
Usable height when stacked	188 mm	
Capacity	19.8 litres	
Load (max.)	50 kg	
Colour	Blue	Grey
Order no.	75744	75745

LTB 4220 VS01 PP with reinforced welded base

Internal dimensions L x W x H	367 x 267 x 203 mm	
Usable height when stacked	188 mm	
Load (max.)	70 kg	
Colour	Blue	Grey
Order no.	79284*	79285*

LTB 6120 PP with reinforced base

External dimensions L x W x H	599 x 399 x 120 mm	
Internal dimensions L x W x H	567 x 367 x 98 mm	
Usable height when stacked	83 mm	
Capacity	20.3 litres	
Load (max.)	50 kg	
Colour	Blue	Grey
Order no.	75784	75785

LTB 6120 VS01 PP with reinforced welded base

Internal dimensions L x W x H	567 x 367 x 98 mm	
Usable height when stacked	83 mm	
Load (max.)	70 kg	
Colour	Blue	Grey
Order no.	76104*	76105*

600 x 400 x 120 mm



LTB 6170 PP with reinforced base

External dimensions L x W x H	599 x 399 x 170 mm	
Internal dimensions L x W x H	567 x 367 x 148 mm	
Usable height when stacked	133 mm	
Capacity	30.7 litres	
Load (max.)	50 kg	
Colour	Blue	Grey
Order no.	75804	75805

LTB 6170 VS01 PP with reinforced welded base

Internal dimensions L x W x H	567 x 367 x 148 mm	
Usable height when stacked	133 mm	
Load (max.)	70 kg	
Colour	Blue	Grey
Order no.	76114*	76115*

LTB 6170 GL PP with smooth base

Internal dimensions L x W x H	554 x 354 x 167 mm	
Usable height when stacked	152 mm	
Capacity	34.5 litres	
Load (max.)	25 kg	
Colour	Blue	Grey
Order no.	86054*	86055*

600 x 400 x 170 mm



LTB 6220 PP with reinforced base

External dimensions L x W x H	599 x 399 x 220 mm	
Internal dimensions L x W x H	567 x 367 x 198 mm	
Usable height when stacked	183 mm	
Capacity	41.0 litres	
Load (max.)	50 kg	
Colour	Blue	Grey
Order no.	75824	75825

LTB 6220 VS01 PP with reinforced welded base

Internal dimensions L x W x H	567 x 367 x 198 mm	
Usable height when stacked	183 mm	
Load (max.)	70 kg	
Colour	Blue	Grey
Order no.	76124*	76125*

LTB 6220 GL PP with smooth base

Internal dimensions L x W x H	554 x 354 x 217 mm	
Usable height when stacked	202 mm	
Capacity	42.3 litres	
Load (max.)	25 kg	
Colour	Blue	Grey
Order no.	79304*	79305*

600 x 400 x 220 mm



* = Article on request

Standard models

600 x 400 x 270 mm



LTB 6270 PP with reinforced base

External dimensions L x W x H	599 x 399 x 270 mm	
Internal dimensions L x W x H	567 x 367 x 248 mm	
Usable height when stacked	233 mm	
Capacity	51.4 litres	
Load (max.)	50 kg	
Colour	Blue	Grey
Order no.	75844	75845

LTB 6270 VS01 PP with reinforced welded base

Internal dimensions L x W x H	567 x 367 x 248 mm	
Usable height when stacked	233 mm	
Load (max.)	70 kg	
Colour	Blue	Grey
Order no.	76134*	76135*

600 x 400 x 320 mm



LTB 6320 PP with reinforced base

External dimensions L x W x H	599 x 399 x 320 mm	
Internal dimensions L x W x H	567 x 367 x 298 mm	
Usable height when stacked	283 mm	
Capacity	61.7 litres	
Load (max.)	50 kg	
Colour	Blue	Grey
Order no.	75864	75865

LTB 6320 VS01 PP with reinforced welded base

Internal dimensions L x W x H	567 x 367 x 298 mm	
Usable height when stacked	283 mm	
Load (max.)	70 kg	
Colour	Blue	Grey
Order no.	76144*	76145*

600 x 400 x 420 mm



LTB 6420 PP with reinforced base

External dimensions L x W x H	599 x 399 x 420 mm	
Internal dimensions L x W x H	567 x 367 x 398 mm	
Usable height when stacked	383 mm	
Capacity	82.3 litres	
Load (max.)	50 kg	
Colour	Blue	Grey
Order no.	86064	86065

LTB 6420 VS01 PP with reinforced welded base

Internal dimensions L x W x H	567 x 367 x 398 mm	
Usable height when stacked	383 mm	
Load (max.)	70 kg	
Colour	Blue	Grey
Order no.	86074*	86075*

LTB 8220 GL PP with smooth base

External dimensions L x W x H 799 x 599 x 220 mm

Internal dimensions L x W x H 752 x 552 x 217 mm

Usable height when stacked 197 mm

Capacity 91.8 litres

Load (max.) 25 kg

Colour **Blue** **Grey**Order no. **76014*** **76015*****LTB 8220 VS05 PP** with reinforced welded base

Internal dimensions L x W x H 755 x 555 x 197 mm

Usable height when stacked 177 mm

Capacity 84.5 litres

Load (max.) 70 kg

Colour **Blue** **Grey**Order no. **76024*** **76025*****800 x 600 x 220 mm****LTB 8320 GL PP** with smooth base

External dimensions L x W x H 799 x 599 x 320 mm

Internal dimensions L x W x H 752 x 552 x 317 mm

Usable height when stacked 297 mm

Capacity 135.0 litres

Load (max.) 25 kg

Colour **Blue** **Grey**Order no. **76244** **76245****LTB 8320 VS05 PP** with reinforced welded base

Internal dimensions L x W x H 755 x 555 x 297 mm

Usable height when stacked 277 mm

Capacity 125.0 litres

Load (max.) 70 kg

Colour **Blue** **Grey**Order no. **76284*** **76285*****800 x 600 x 320 mm****LTB 8420 GL PP** with smooth base

External dimensions L x W x H 799 x 599 x 420 mm

Internal dimensions L x W x H 752 x 552 x 417 mm

Usable height when stacked 397 mm

Capacity 175.0 litres

Load (max.) 25 kg

Colour **Blue** **Grey**Order no. **76264*** **76265*****LTB 8420 VS05 PP** with reinforced welded base

Internal dimensions L x W x H 755 x 555 x 397 mm

Usable height when stacked 377 mm

Capacity 165.0 litres

Load (max.) 70 kg

Colour **Blue** **Grey**Order no. **76294*** **76295*****800 x 600 x 420 mm**

With two-part hinged lids

400 x 300 x 137 mm



LTB-DH 4120 PP with reinforced base

External dimensions L x W x H	399 x 299 x 137 mm	
Internal dimensions L x W x H	367 x 267 x 103 mm	
Usable height when stacked	88 mm	
Capacity	10.0 litres	
Load (max.)	50 kg	
Colour	Blue	Grey
Order no.	75714*	75715*

LTB-DH 4120 VS01 PP with reinforced welded base

Internal dimensions L x W x H	367 x 267 x 103 mm	
Usable height when stacked	88 mm	
Load (max.)	70 kg	
Colour	Blue	Grey
Order no.	79274*	79275*

400 x 300 x 237 mm



LTB-DH 4220 PP with reinforced base

External dimensions L x W x H	399 x 299 x 237 mm	
Internal dimensions L x W x H	367 x 267 x 203 mm	
Usable height when stacked	188 mm	
Capacity	19.8 litres	
Load (max.)	50 kg	
Colour	Blue	Grey
Order no.	75754*	75755*

LTB-DH 4220 VS01 PP with reinforced welded base

Internal dimensions L x W x H	367 x 267 x 203 mm	
Usable height when stacked	188 mm	
Load (max.)	70 kg	
Colour	Blue	Grey
Order no.	79294*	79295*

LTB-DH 6120 PP with reinforced base

External dimensions L x W x H	599 x 399 x 137 mm	
Internal dimensions L x W x H	567 x 367 x 98 mm	
Usable height when stacked	83 mm	
Capacity	20.3 litres	
Load (max.)	50 kg	
Colour	Blue	Grey
Order no.	75794*	75795*

LTB-DH 6120 VS01 PP with reinforced welded base

Internal dimensions L x W x H	567 x 367 x 98 mm	
Usable height when stacked	83 mm	
Load (max.)	70 kg	
Colour	Blue	Grey
Order no.	76154*	76155*

600 x 400 x 137 mm



LTB-DH 6170 PP with reinforced base

External dimensions L x W x H	599 x 399 x 187 mm	
Internal dimensions L x W x H	567 x 367 x 148 mm	
Usable height when stacked	133 mm	
Capacity	30.7 litres	
Load (max.)	50 kg	
Colour	Blue	Grey
Order no.	75814*	75815*

LTB-DH 6170 VS01 PP with reinforced welded base

Internal dimensions L x W x H	567 x 367 x 148 mm	
Usable height when stacked	133 mm	
Load (max.)	70 kg	
Colour	Blue	Grey
Order no.	76164*	76165*

LTB-DH 6170 GL PP with smooth base

Internal dimensions L x W x H	554 x 354 x 167 mm	
Usable height when stacked	152 mm	
Capacity	34.5 litres	
Load (max.)	25 kg	
Colour	Blue	Grey
Order no.	86224*	86225*

600 x 400 x 187 mm



LTB-DH 6220 PP with reinforced base

External dimensions L x W x H	599 x 399 x 237 mm	
Internal dimensions L x W x H	567 x 367 x 198 mm	
Usable height when stacked	183 mm	
Capacity	41.0 litres	
Load (max.)	50 kg	
Colour	Blue	Grey
Order no.	75834*	75835*

LTB-DH 6220 VS01 PP with reinforced welded base

Internal dimensions L x W x H	567 x 367 x 198 mm	
Usable height when stacked	183 mm	
Load (max.)	70 kg	
Colour	Blue	Grey
Order no.	76174*	76175*

LTB-DH 6220 GL PP with smooth base

Internal dimensions L x W x H	554 x 354 x 217 mm	
Usable height when stacked	202 mm	
Capacity	42.3 litres	
Load (max.)	25 kg	
Colour	Blue	Grey
Order no.	79314*	79315*

600 x 400 x 237 mm



* = Article on request

With two-part hinged lids

600 x 400 x 287 mm



LTB-DH 6270 PP with reinforced base

External dimensions L x W x H	599 x 399 x 287 mm	
Internal dimensions L x W x H	567 x 367 x 248 mm	
Usable height when stacked	233 mm	
Capacity	51.4 litres	
Load (max.)	50 kg	
Colour	Blue	Grey
Order no.	75854*	75855*

LTB-DH 6270 VS01 PP with reinforced welded base

Internal dimensions L x W x H	567 x 367 x 248 mm	
Usable height when stacked	233 mm	
Load (max.)	70 kg	
Colour	Blue	Grey
Order no.	76184*	76185*

600 x 400 x 337 mm



LTB-DH 6320 PP with reinforced base

External dimensions L x W x H	599 x 399 x 337 mm	
Internal dimensions L x W x H	567 x 367 x 298 mm	
Usable height when stacked	283 mm	
Capacity	61.7 litres	
Load (max.)	50 kg	
Colour	Blue	Grey
Order no.	75874*	75875*

LTB-DH 6320 VS01 PP with reinforced welded base

Internal dimensions L x W x H	567 x 367 x 298 mm	
Usable height when stacked	283 mm	
Load (max.)	70 kg	
Colour	Blue	Grey
Order no.	76194*	76195*

600 x 400 x 437 mm



LTB-DH 6420 PP with reinforced base

External dimensions L x W x H	599 x 399 x 437 mm	
Internal dimensions L x W x H	567 x 367 x 398 mm	
Usable height when stacked	383 mm	
Capacity	82.3 litres	
Load (max.)	50 kg	
Colour	Blue	Grey
Order no.	86204*	86205*

LTB-DH 6420 VS01 PP with reinforced welded base

Internal dimensions L x W x H	567 x 367 x 398 mm	
Usable height when stacked	383 mm	
Load (max.)	70 kg	
Colour	Blue	Grey
Order no.	86214*	86215*

With skids

LTB 8220 VS05 KU600 PP

External dimensions L x W x H	799 x 599 x 320 mm	
Internal dimensions L x W x H	755 x 555 x 197 mm	
Usable height when stacked	177 mm	
Capacity	84.5 litres	
Fork clearance	100 mm	
Load (max.)	200 kg	
Live load (max.)	750 kg	
Colour	Blue	Grey
Order no.	76044*	76035*

800 x 600 x 320 mm

**LTB 8320 VS05 KU600 PP**

External dimensions L x W x H	799 x 599 x 420 mm	
Internal dimensions L x W x H	755 x 555 x 297 mm	
Usable height when stacked	277 mm	
Capacity	125.0 litres	
Fork clearance	100 mm	
Load (max.)	200 kg	
Live load (max.)	750 kg	
Colour	Blue	Grey
Order no.	762804*	762805*

800 x 600 x 420 mm

**LTB 8420 VS05 KU600 PP**

External dimensions L x W x H	799 x 599 x 520 mm	
Internal dimensions L x W x H	755 x 555 x 397 mm	
Usable height when stacked	377 mm	
Capacity	165.0 litres	
Fork clearance	100 mm	
Load (max.)	200 kg	
Live load (max.)	750 kg	
Colour	Blue	Grey
Order no.	762904*	762905*

800 x 600 x 520 mm



With castors

800 x 600 x 375 mm



LTB 8220 VS05-RL125 PP

External dimensions L x W x H	799 x 599 x 375 mm	
Internal dimensions L x W x H	755 x 555 x 197 mm	
Capacity	84.5 litres	
Fork clearance	125 mm	
Colour	Blue	Grey
Order no.	76044*	76045*

800 x 600 x 475 mm



LTB 8320 VS05-RL125 PP

External dimensions L x W x H	799 x 599 x 475 mm	
Internal dimensions L x W x H	755 x 555 x 297 mm	
Capacity	125.0 litres	
Fork clearance	125 mm	
Colour	Blue	Grey
Order no.	76304*	76305*

800 x 600 x 575 mm



LTB 8420 VS05 RO PP

External dimensions L x W x H	799 x 599 x 575 mm	
Internal dimensions L x W x H	755 x 555 x 397 mm	
Capacity	165.0 litres	
Fork clearance	125 mm	
Colour	Blue	Grey
Order no.	76314*	76315*

Lids

LTB-D 43 PP drop-on lid

Colour	Blue	Grey
Order no.	75904	75905

LTB-D 43 S PP with hinges**

Colour	Blue	Grey
Order no.	76204	76205

** including two lid hinges (lid clips available on request)

Basic dimensions 400 x 300 mm



LTB-D 64 PP drop-on lid

Colour	Blue	Grey
Order no.	75914	75915

LTB-D 64 S PP with hinges**

Colour	Blue	Grey
Order no.	76214	76215

** including two lid hinges (lid clips available on request)

Basic dimensions 600 x 400 mm



Lid clips

Colour	White
Order no.	99237



Lid clip (on request)



Lid with hinges



Drop-on lid

Pallet covers

Basic dimensions 800 x 600 mm

ADH-T 86 PP deep-drawn pallet cover

Colour	Black
Order no.	171600*



A 1208 PP pallet cover

Colour	Blue
Order no.	39704

A 1208-1 PP pallet cover

Colour	Blue
Order no.	35614

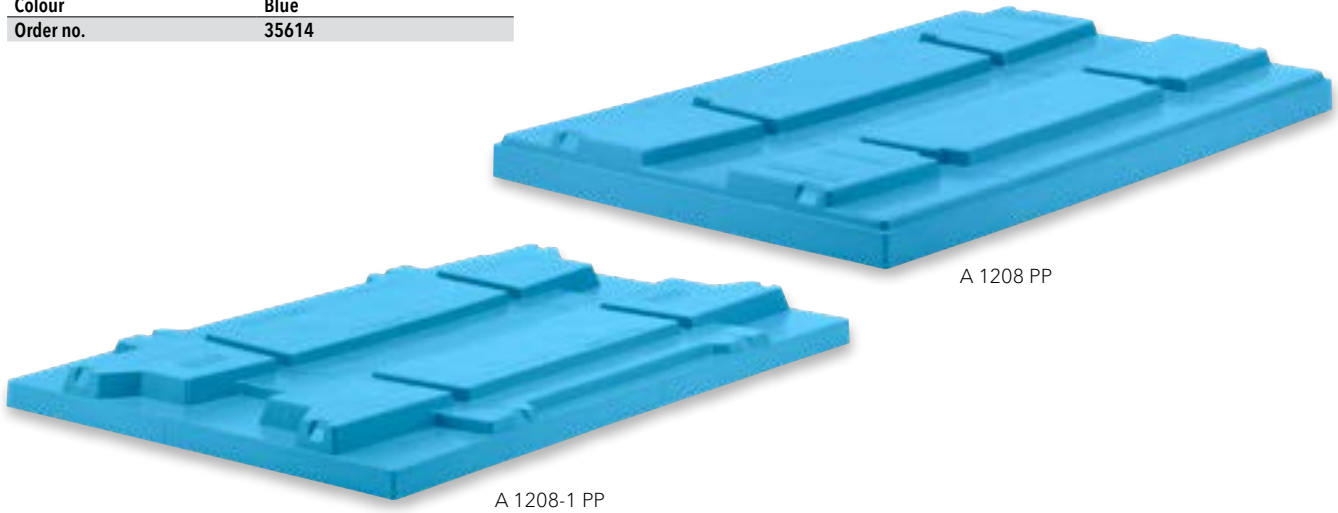
Basic dimensions 1200 x 800 mm

Dividers for basic dimensions 600 x 400 mm



TWH 1

Divider holder

For ELB, LTF and LTB

TWH 1 PP for lengthwise and crosswise dividers

Quantity required	Two per divider
Colour	Black
Order no.	187858

Partitioning examples for 130 mm dividers

Standard hole pattern up to 8-way crosswise
(3 holes on long side, 1 on short side)

Custom hole patterns are available for orders of 500
containers or more



2-way crosswise partitioning*
Compartment size: 278 x 366 mm



1 x QTW 130-0
2 x TWH 1

2-way lengthwise partitioning*
Compartment size: 566 x 178 mm

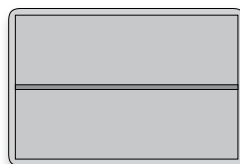

1 x LTW 130-0
2 x TWH 1

3-way crosswise partitioning*
Compartment size: 182 x 366 mm



2 x QTW 130-0
4 x TWH 1

For containers of the ELB, LTF and LTB ranges

3-way lengthwise partitioning*

Compartment size: 566 x 115 mm

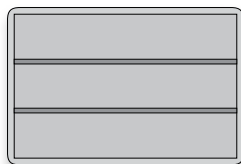

2x LTW 130-0
4x TWH 1

4-way crosswise partitioning*

Compartment size: 134 x 366 mm



3x QTW 130-0
6x TWH 1

4-way lengthwise partitioning*

Compartment size: 566 x 84 mm



3x LTW 130-0
6x TWH 1

4-way partitioning*

Compartment size: 278 x 178 mm



1x QTW 130-1
1x LTW 130-1
4x TWH 1

6-way crosswise partitioning*

Compartment size: 182 x 178 mm



2x QTW 130-1
1x LTW 130-2
6x TWH 1

6-way lengthwise partitioning

Compartment size: 278 x 115 mm

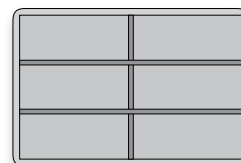

1x QTW 130-2
2x LTW 130-1
6x TWH 1

8-way crosswise partitioning*

Compartment size: 134 x 178 mm



3x QTW 130-1
1x LTW 130-3
8x TWH 1

8-way lengthwise partitioning

Compartment size: 278 x 84 mm

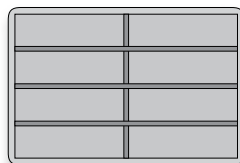

1x QTW 130-3
3x LTW 130-1
8x TWH 1

10-way crosswise partitioning**

Compartment size: 105 x 178 mm

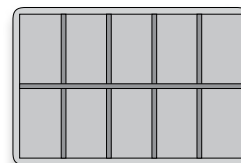

4x QTW 130-1
1x LTW 130-4
10x TWH 1

12-way crosswise partitioning

Compartment size: 134 x 115 mm



3x QTW 130-2
2x LTW 130-3
10x TWH 1

12-way lengthwise partitioning

Compartment size: 182 x 84 mm

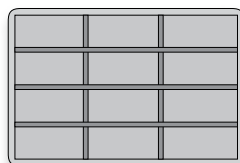

2x QTW 130-3
3x LTW 130-2
10x TWH 1

16-way partitioning

Compartment size: 134 x 84 mm



3x QTW 130-3
3x LTW 130-3
12x TWH 1

20-way partitioning**

Compartment size: 105 x 84 mm



4x QTW 130-3
3x LTW 130-4
14x TWH 1

* Achievable with standard hole pattern

** Only possible with 130 mm high dividers

Dividers for basic dimensions 600 x 400 mm

Longitudinal dividers 130 mm

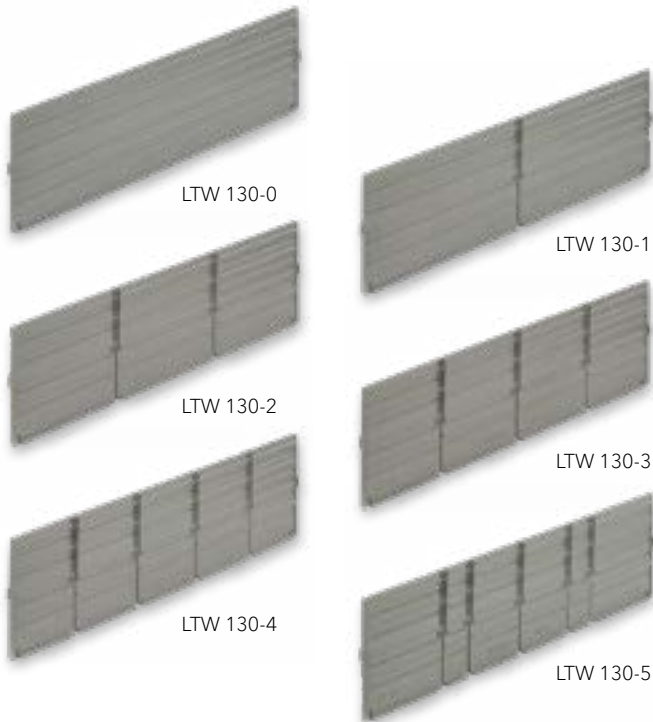

	LTW 130-0 PS	LTW 130-0og PS
For containers with	closed grips	open grips
Divider height	130 mm	130 mm
Number of slots	-	-
Colour	Grey	Grey
Order no.	187525*	187635*
	LTW 130-1 PS	LTW 130-1og PS
Number of slots	1 unit	1 unit
Colour	Grey	Grey
Order no.	187535*	187645*
	LTW 130-2 PS	LTW 130-2og PS
Number of slots	2 units	2 units
Colour	Grey	Grey
Order no.	187545*	187655*
	LTW 130-3 PS	LTW 130-3og PS
Number of slots	3 units	3 units
Colour	Grey	Grey
Order no.	187555*	187665*
	LTW 130-4 PS	LTW 130-4og PS
Number of slots	4 units	4 units
Colour	Grey	Grey
Order no.	187565	187675
	LTW 130-5 PS	LTW 130-5og PS
Number of slots	5 units	5 units
Colour	Grey	Grey
Order no.	187575*	187685*

Longitudinal dividers 180 mm

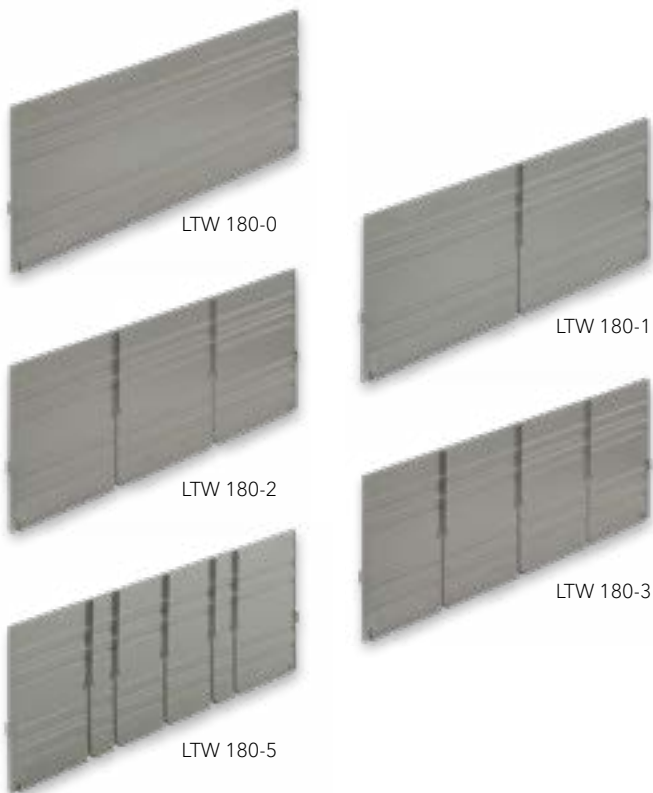

	LTW 180-0 PS	LTW 180-0og PS
For containers with	closed grips	open grips
Divider height	180 mm	180 mm
Number of slots	-	-
Colour	Grey	Grey
Order no.	187585*	187695*
	LTW 180-1 PS	LTW 180-1og PS
Number of slots	1 unit	1 unit
Colour	Grey	Grey
Order no.	187595*	187705*
	LTW 180-2 PS	LTW 180-2og PS
Number of slots	2 units	2 units
Colour	Grey	Grey
Order no.	187605*	187715*
	LTW 180-3 PS	LTW 180-3og PS
Number of slots	3 units	3 units
Colour	Grey	Grey
Order no.	187615*	187725*
	LTW 180-5 PS	LTW 180-5og PS
Number of slots	5 units	5 units
Colour	Grey	Grey
Order no.	187625*	187735*



Longitudinal dividers, "og" type, for containers with open grips - example: LTB container

For containers of the ELB, LTF and LTB ranges

QTW 130-0 PS

Divider height 130 mm

Number of slots -

Colour Grey

Order no. 187745*

QTW 130-1 PS

Number of slots 1 unit

Colour Grey

Order no. 187755*

QTW 130-2 PS

Number of slots 2 units

Colour Grey

Order no. 187765*

QTW 130-3 PS

Number of slots 3 units

Colour Grey

Order no. 187775*

QTW 130-5 PS

Number of slots 5 units

Colour Grey

Order no. 187795*

Crosswise dividers 130 mm



QTW 180-0 PS

Divider height 180 mm

Number of slots -

Colour Grey

Order no. 187805*

QTW 180-1 PS

Number of slots 1 unit

Colour Grey

Order no. 187815*

QTW 180-2 PS

Number of slots 2 units

Colour Grey

Order no. 187825*

QTW 180-3 PS

Number of slots 3 units

Colour Grey

Order no. 187835*

QTW 180-5 PS

Number of slots 5 units

Colour Grey

Order no. 187845*

Crosswise dividers 180 mm



Insert boxes - efficiency and tidiness

Insert boxes are an ideal solution for organising and safely storing small components. In boxes, drawers and containers, our insert boxes ensure tidiness, optimum space utilisation and a clear overview.

These flexibly usable boxes withstand most oils, acids and alkalis, while the smooth interior walls are easy to clean.

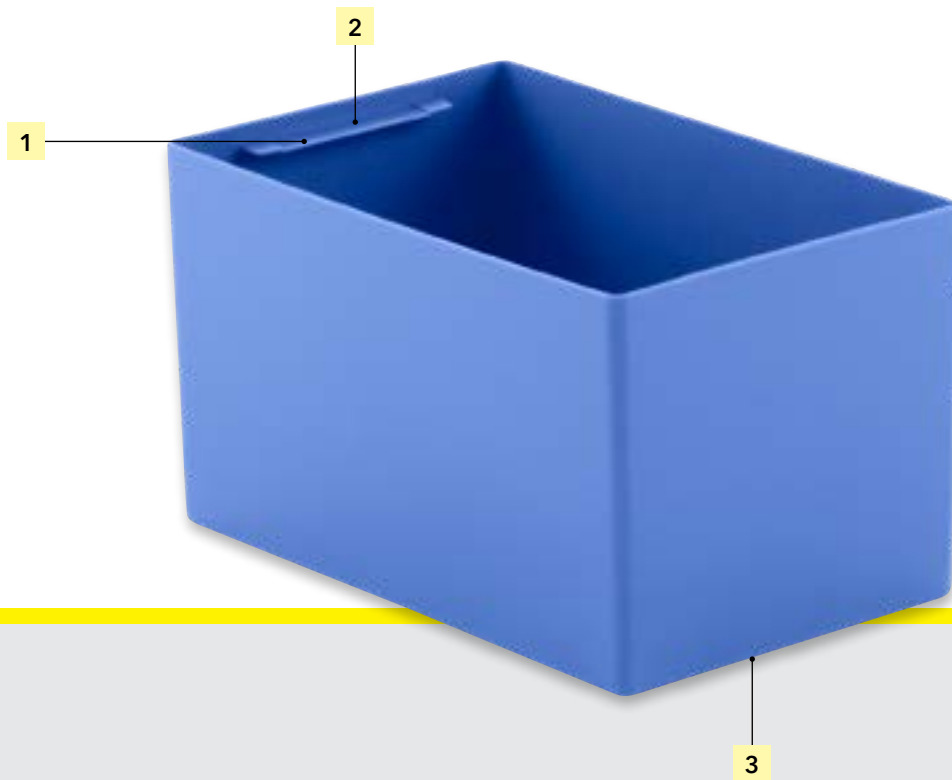

1| Tab
to facilitate removal



2| Tab
with barcode for content labelling



3| Base

Standard colours:





Key facts

- Small component organiser
- Maximum capacity utilisation of the container for products that do not need to be stored in large quantities

Typical customer applications

- In our containers, in drawers of cupboards and workbenches
- Efficient, smart availability of slow-moving items
- Assembly containers



Partitioning example
for basic dimensions 400 x 300 mm



Partitioning example
for basic dimensions 600 x 400 mm

For all stackable Euro containers

Basic dimensions 600 x 400 mm



EK 6161 PP

External dimensions	140 x 90 x 80 mm
L x W x H	
Packaging unit	84 units
Colour	Blue
Order no.	4764

EK 6161 PPL conductive model

Colour	Black, conductive
Order no.	4768



EK 6081 PP

External dimensions	179 x 140 x 80 mm
L x W x H	
Packaging unit	48 units
Colour	Blue
Order no.	4754

EK 6081 PPL conductive model

Colour	Black, conductive
Order no.	4758



EK 6082 PP

External dimensions	179 x 140 x 150 mm
L x W x H	
Packaging unit	32 units
Colour	Blue
Order no.	79354

EK 6082 PPL conductive model

Colour	Black, conductive
Order no.	79358*

Partitioning examples



16 x EK 6161



8 x EK 6081



8 x EK 6082

EK 6041 PP

External dimensions L x W x H	279 x 179 x 80 mm
Packaging unit	36 units
Colour	Blue
Order no.	4734

EK 6041 PPL conductive model

Colour	Black, conductive
Order no.	4738

EK 6042 PP

External dimensions L x W x H	279 x 179 x 150 mm
Packaging unit	18 units
Colour	Blue
Order no.	4724

EK 6042 PPL conductive model

Colour	Black, conductive
Order no.	4728

EK 6021 Q PP

External dimensions L x W x H	358 x 279 x 80 mm
Packaging unit	18 units
Colour	Blue
Order no.	79364

EK 6021 Q PPL conductive model

Colour	Black, conductive
Order no.	79368

Basic dimensions 600 x 400 mm



Partitioning examples



4 x EK 6041



4 x EK 6042



2 x EK 6021 Q

For all stackable Euro containers

Basic dimensions 600 x 400 mm



EK 6022 Q PP

External dimensions	358 x 279 x 150 mm
L x W x H	
Packaging unit	12 units
Colour	Blue
Order no.	4774

EK 6022 Q PPL conductive model

Colour	Black, conductive
Order no.	4778

EK 6041 L PP

External dimensions	558 x 90 x 80 mm
L x W x H	
Packaging unit	48 units
Colour	Blue
Order no.	4744

EK 6041 L PPL conductive model

Colour	Black, conductive
Order no.	4748*

EK 6022 L PP

External dimensions	558 x 179 x 150 mm
L x W x H	
Packaging unit	12 units
Colour	Blue
Order no.	4714

EK 6022 L PPL conductive model

Colour	Black, conductive
Order no.	4718

Partitioning examples

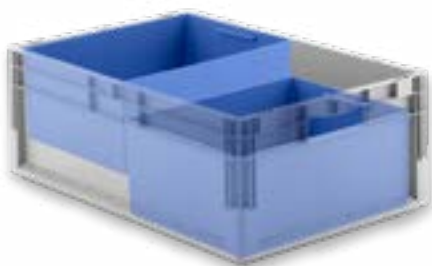

2 x EK 6022 Q



4 x EK 6041 L



2 x EK 6022 L

EK 6021 PP

External dimensions L x W x H	558 x 179 x 80 mm
Packaging unit	24 units
Colour	Blue
Order no.	1944

EK 6021 PPL conductive model

Colour	Black, conductive
Order no.	1948

EK 6023 L PP

External dimensions L x W x H	558 x 179 x 215 mm
Packaging unit	24 units
Colour	Blue
Order no.	4784*

EK 6023 L PPL conductive model

Colour	Black, conductive
Order no.	4788*

Basic dimensions 600 x 400 mm



Partitioning examples



2 x EK 6021

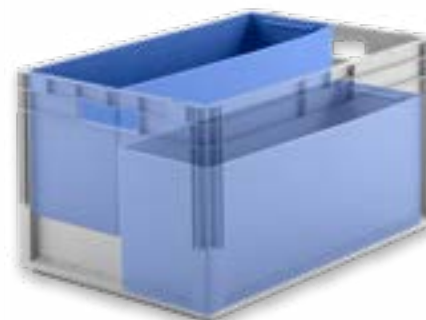

2 x EK 6023 L

Trays for non-conveyable containers and cartons

Automated small-parts warehouses and conveyor installations are complex systems that depend on a smooth, uninterrupted flow of materials. Anything else would cost valuable time and money. But not all containers are ideal for such systems – cardboard boxes, for example, cannot simply be put into storage or transported on conveyors as they are. Over the years, with great technical finesse, we have developed a variety of trays for precisely these cases.

The trays accommodate a large variety of plastic and cardboard boxes and guarantee trouble-free, efficient material flows. This means that all goods can be stored and retrieved directly without any additional time or transported using conveyor technology.



Trays with...
smooth inner surfaces
for cardboard boxes



... some also with
lifting openings in the base



Trays with insert for lifting *
in various sizes and models

Top of lifting base, smooth

Underside of tray insert for lifting





Key facts

- Tried-and-tested trays for light to heavy-duty applications for automated systems
- For handling Euro-size containers
- For oversize applications

Typical customer applications

- Existing containers cannot be conveyed, or only poorly, (e.g. KLT containers with composite bases or containers that are too unstable in terms of their quality). In these cases, a tray insert is more cost-effective than replacing the existing containers.
- Cardboard boxes that cannot be conveyed due to poor quality. In this case, the use of a tray is technically essential in order to automate.
- Several different container sizes are in use. Automating all of these would be infeasible from a technical and economic point of view, so trays are used here, onto which in turn fit the various existing customer containers.

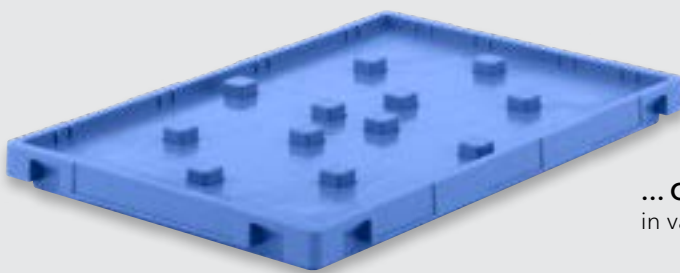

... Or with retractable retaining elements
in various quantities and positions



Standard colours:



EFT range

400 x 300 x 72 mm



4 x EF 2120

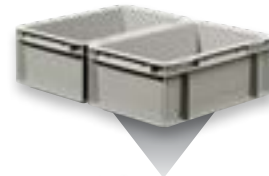

2 x EF 3120

EFT 4070 PP with retaining elements

External dimensions L x W x H 399 x 299 x 72 mm

Internal dimensions L x W x H 357 x 257 x 60 mm

Load (max.) 15 kg

Colour **Blue** **Grey**

Order no. **15544*** **15545***

EFT 4070 PPL conductive model

Colour **Black, conductive**

Order no. **15548***

MF range

MF 4060 PP

External dimensions L x W x H	396 x 297 x 60 mm	
Internal dimensions L x W x H	366 x 267 x 42 mm	
Load (max.)	20 kg	
Colour	Blue	Grey
Order no.	38734	38735

MF 4060 PPL conductive model

Colour	Black, conductive
Order no.	38738

400 x 300 x 60 mm



2x MF 3120



1x MF 3120 and 2x MF 2120



4x MF 2120

MF 4060 S01 PP with retaining elements

External dimensions L x W x H	396 x 297 x 60 mm	
Internal dimensions L x W x H	366 x 267 x 42 mm	
Load (max.)	30 kg	
Colour	Blue	Grey
Order no.	39034*	39035*

MF 4060 S01 PPL conductive model

Colour	Black, conductive
Order no.	39038*

400 x 300 x 60 mm



2x MF 3120



1x MF 3120 and 2x MF 2120



4x MF 2120

* = Article on request

MF range

600 x 400 x 60 mm



MF 6060 S01 PP with retaining elements

External dimensions L x W x H	594 x 396 x 60 mm	
Internal dimensions L x W x H	564 x 366 x 42 mm	
Load (max.)	30 kg	
Colour	Blue	Grey
Order no.	38874*	38875*

MF 6060 S01 PPL conductive model

Colour	Black, conductive	
Order no.	38878*	

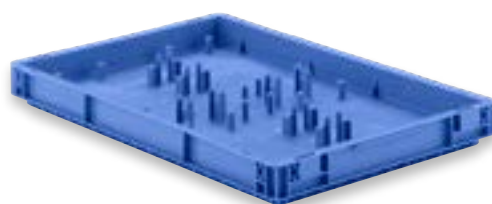

2x MF 4120



4x MF 3120



8x MF 2120

600 x 400 x 68 mm

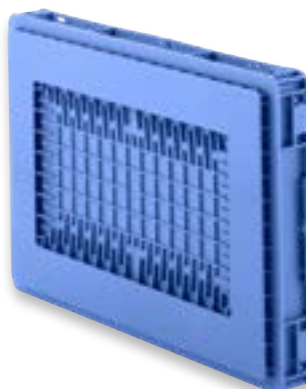

MF 6070 PP

External dimensions L x W x H	594 x 396 x 68 mm	
Internal dimensions L x W x H	564 x 366 x 50 mm	
Load (max.)	30 kg	
Colour	Blue	Grey
Order no.	39344*	39345*

MF 6070 PPL conductive model

Colour	Black, conductive	
Order no.	39348*	



1x carton



2x MF 4120



4x MF 3120

MF Tray 6070 PP with retaining elements		
External dimensions L x W x H	594 x 396 x 68 mm	
Internal dimensions L x W x H	564 x 366 x 50 mm	
Load (max.)	30 kg	
Colour	Blue	Grey
Order no.	39414*	39415*
MF Tray 6070 PPL conductive model		
Colour	Black, conductive	
Order no.	39418*	

600 x 400 x 68 mm



4x MF 2120 and 2x MF 3120



4x MF 3120



2x MF 4120



16x TK 150

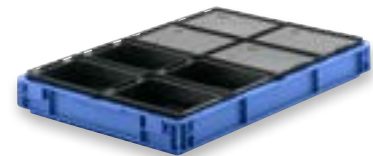

8x TK 200



Our expertise: Plastic containers

Storage & transport containers for manual handling

Containers for semi- and fully automated systems

Space-saving containers

Containers for storing small parts

Industry solutions for the automotive industry

* = Article on request

LTS range

600 x 400 x 45 mm

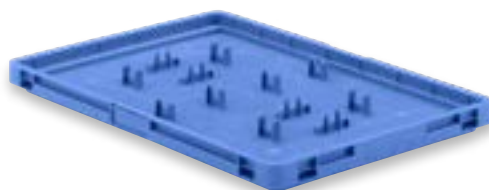

2x MF 4270

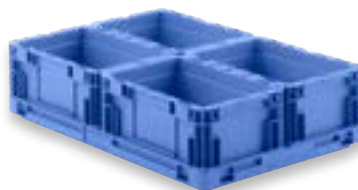

4x MF 3120



8x MF 2120

LTS-T6 VS02-MF PP also for retaining single containers

External dimensions L x W x H 594 x 396 x 46 mm

Internal dimensions L x W x H 562 x 364 x 25 mm

Load (max.) 70 kg

Colour **Blue** **Grey**

Order no. **37374*** **37375***

LTS-T6 VS02-MF PPL conductive model

Colour **Black, conductive**

Order no. **37378***

600 x 400 x 46 mm



LTS-T6 G VS02 PP with smooth inner surfaces and reinforced welded base

External dimensions L x W x H 594 x 396 x 46 mm

Internal dimensions L x W x H 568 x 367 x 25 mm

Load (max.) 70 kg

Colour **Blue** **Grey**

Order no. **25754*** **25755***

LTS-T6 G VS02 PPL conductive model

Colour **Black, conductive**

Order no. **25758***

LTS-T6-VS02 PP with reinforced welded base

External dimensions L x W x H	594 x 396 x 46 mm	
Internal dimensions L x W x H	568 x 367 x 25 mm	
Load (max.)	70 kg	
Colour	Blue	Grey
Order no.	37384*	37385*

LTS-T6-VS02 PPL conductive model

Colour	Black, conductive	
Order no.	37388*	

600 x 400 x 46 mm

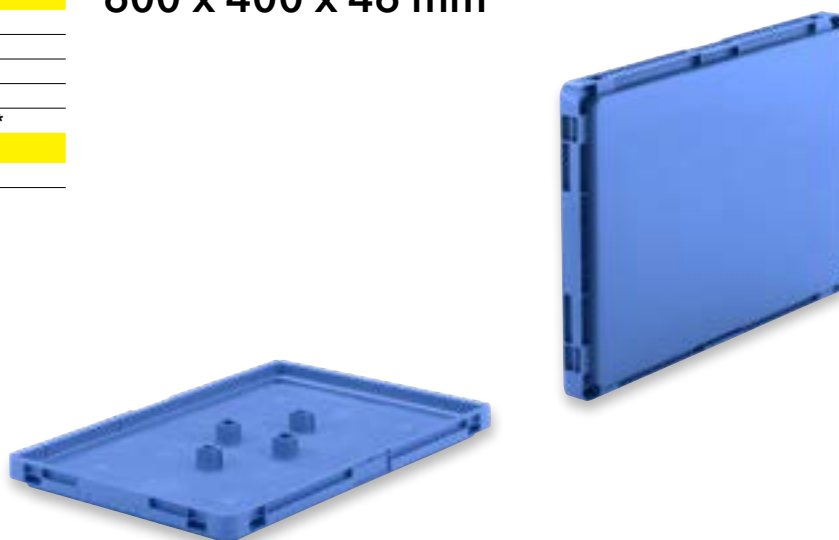
**LTS-T6-VS02-C PP** with retaining elements for C-KLT containers and reinforced welded base

External dimensions L x W x H	596 x 396 x 46 mm	
Internal dimensions L x W x H	567 x 366 x 25 mm	
Load (max.)	70 kg	
Colour	Blue	Grey
Order no.	79234*	79235*

LTS-T6-VS02-C PPL conductive model

Colour	Black, conductive	
Order no.	79238*	

600 x 400 x 46 mm

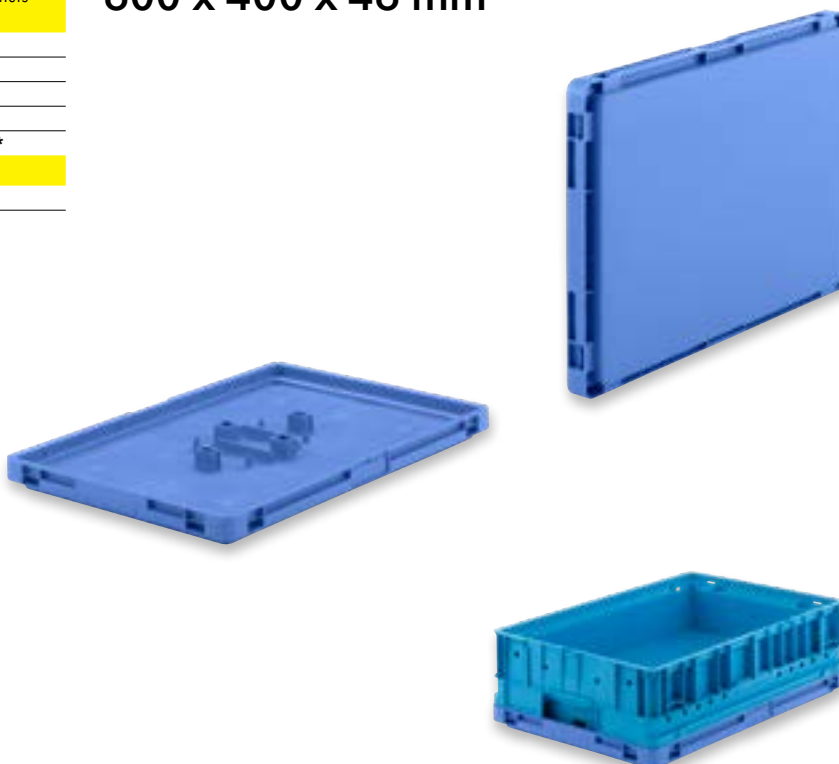

1 x C-KLT 6414

LTS range

600 x 400 x 47 mm

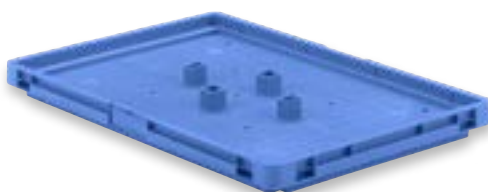

LTS-T6 PP

External dimensions L x W x H 594 x 396 x 46.6 mm

Internal dimensions L x W x H 530 x 367 x 25 mm

Load (max.) 50 kg

Colour **Blue** **Grey**

Order no. **37214*** **37215***

LTS-T6 PPL conductive model

Colour **Black, conductive**

Order no. **37218***

600 x 400 x 47 mm



LTS-T6 G PP with smooth inner surfaces

External dimensions L x W x H 594 x 396 x 46.6 mm

Internal dimensions L x W x H 568 x 364 x 25 mm

Load (max.) 50 kg

Colour **Blue** **Grey**

Order no. **37224*** **37225***

LTS-T6 G PPL conductive model

Colour **Black, conductive**

Order no. **37228***



LTS-T6 Z PP with pull grip on short side

External dimensions L x W x H 594 x 396 x 46.6 mm

Internal dimensions L x W x H 568 x 364 x 25 mm

Load (max.) 50 kg

Colour **Blue** **Grey**Order no. **37234*** **37235*****LTS-T6 Z PPL** conductive modelColour **Black, conductive**Order no. **37238***

600 x 400 x 47 mm

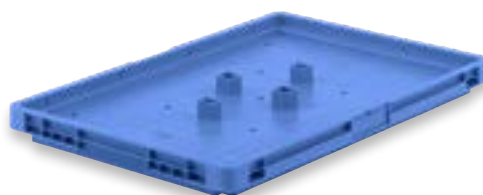
**LTS-T6 GZ PP** with smooth inner surfaces and pull grip on short side

External dimensions L x W x H 594 x 396 x 46.6 mm

Internal dimensions L x W x H 568 x 364 x 25 mm

Load (max.) 50 kg

Colour **Blue** **Grey**Order no. **37244*** **37245*****LTS-T6 GZ PPL** conductive modelColour **Black, conductive**Order no. **37248***

600 x 400 x 47 mm

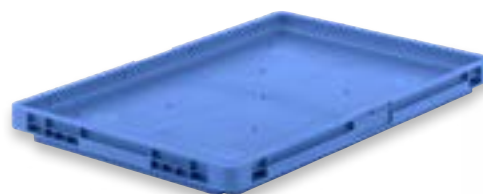

LTS range

630 x 400 x 46 mm



LTS-TR PP

External dimensions L x W x H 627 x 396 x 46 mm

Internal dimensions L x W x H 568 x 364 x 25 mm

Load (max.) 50 kg

Colour **Blue** **Grey**

Order no. **37194*** **37195***

LTS-TR PPL conductive model

Colour **Black, conductive**

Order no. **37198***

T range

T07-VS01-12 PP with 12 retractable retaining elements

External dimensions L x W x H	599 x 399 x 47 mm	
Internal dimensions L x W x H	562 x 365 x 14 mm	
Load (max.)	70 kg	
Colour	Blue	Grey
Order no.	36014*	36015*

T07-VS01-12 PPL conductive model

Colour	Black, conductive	
Order no.	36018*	

The number and positions of the retractable retaining elements can be adapted to the specific project.

600 x 400 x 47 mm

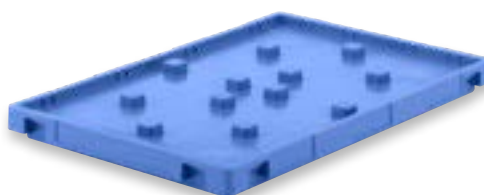

8x MF 2120

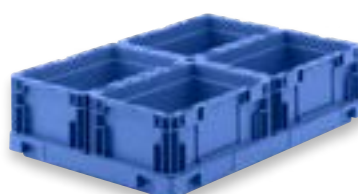

4x MF 3120



2x MF 4120

T15-A1 PP with slot for RFID chip and RFID ISO card

External dimensions L x W x H	340 x 450 x 47 mm	
Internal dimensions L x W x H	315 x 425 x 17 mm	
Load (max.)	30 kg	
Colour	Blue	Grey
Order no.	36024*	36025*

T15-A2 PP with slot for RFID chip and RFID ISO card and anti-tip feet on the base tray

Colour	Blue	Grey
Order no.	36034*	36035*

T15-A4 PP with slot for RFID ISO card

Colour	Blue	Grey
Order no.	36044*	36045*

T15-A6 PP with slot for RFID ISO card plus anti-tip feet on base tray and tray insert for lifting

Colour	Blue	Grey
Order no.	36054*	36055*

T15-A8 PP without slots, without anti-tip feet

Colour	Blue	Grey
Order no.	36064*	36065*

Conductive models available on request.

340 x 450 x 47 mm

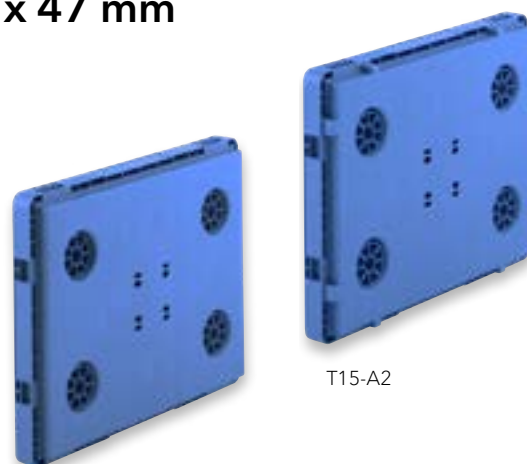

T15-A2

T15-A4



T15-A4



T15-A2

T range

650 x 440 x 47 mm



T14-A7



T14-A7



T14-A3 PP with slot for RFID ISO card plus anti-tip feet on base tray and tray insert for lifting

External dimensions L x W x H	650 x 440 x 47 mm	
Internal dimensions L x W x H	625 x 415 x 17 mm	
Load (max.)	35 kg	
Colour	Blue	Grey
Order no.	36074*	36075*

T14-A7 PP with slot for RFID ISO card

Colour	Blue	Grey
Order no.	36084*	36085*

T14-A3 PPL conductive model

Colour	Black, conductive	
Order no.	36078	

T14-A7 PPL conductive model

Colour	Black, conductive	
Order no.	36088*	

650 x 450 x 47 mm

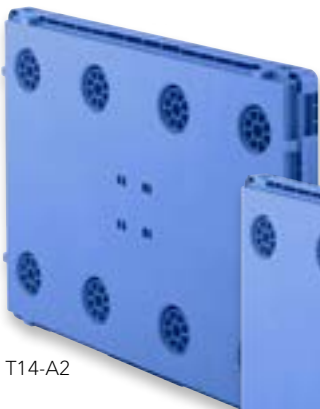

T14-A2

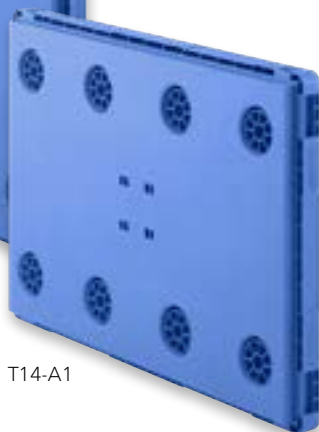

T14-A1

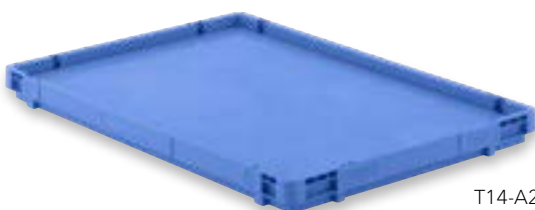

T14-A2



T14-A1

T14-A1 PP with slot for RFID chip and RFID ISO card

External dimensions L x W x H	650 x 450 x 47 mm	
Internal dimensions L x W x H	625 x 425 x 17 mm	
Load (max.)	35 kg	
Colour	Blue	Grey
Order no.	36094*	36095*

T14-A2 PP with slot for RFID chip and RFID ISO card and anti-tip feet on base tray

Colour	Blue	Grey
Order no.	36104*	36105*

T14-A4 PP with slot for RFID ISO card

Colour	Blue	Grey
Order no.	36114*	36115*

T14-A6 PP with slot for RFID ISO card plus anti-tip feet on base tray and tray insert for lifting

Colour	Blue	Grey
Order no.	36124*	36125*

T15-A8 PP without slots, without anti-tip feet

Colour	Blue	Grey
Order no.	36134*	36135*

Conductive models available on request.

T03 PP with special-purpose retaining elements

External dimensions L x W x H	600 x 400 x 65 mm	
Internal dimensions L x W x H	571 x 373 x 48 mm	
Load (max.)	50 kg	
Colour	Blue	Grey
Order no.	25764*	25765*

600 x 400 x 65 mm

T03 PPL conductive model

Colour	Black, conductive
Order no.	25768*



T01 VS02 PP

External dimensions L x W x H	624 x 424 x 56 mm	
Internal dimensions L x W x H	610 x 410 x 34 mm	
Load (max.)	70 kg	
Colour	Blue	Grey
Order no.	25774*	25775*

625 x 425 x 56 mm

T01 VS02 PPL conductive model

Colour	Black, conductive
Order no.	25778*



Our expertise: Plastic containers

Storage & transport containers for manual handling

Containers for semi- and fully automated systems

Space-saving containers

Containers for storing small parts

Industry solutions for the automotive industry

* = Article on request

T range

625 x 425 x 56 mm



T04 VS02 PP

External dimensions L x W x H 624 x 424 x 56 mm

Internal dimensions L x W x H 610 x 410 x 34 mm

Load (max.) 70 kg

Colour **Blue** **Grey**

Order no. **25384*** **25385***

T04 VS02 PPL conductive model

Colour **Black, conductive**

Order no. **25388***

625 x 425 x 56 mm



T06 VS02 PP

External dimensions L x W x H 624 x 424 x 56 mm

Internal dimensions L x W x H 609 x 409 x 34 mm

Load (max.) 70 kg

Colour **Blue** **Grey**

Order no. **25784*** **25785***

T06 VS02 PPL conductive model

Colour **Black, conductive**

Order no. **25788***

T09 VS02 PP without holes for lifting

External dimensions L x W x H 720 x 520 x 73 mm

Internal dimensions L x W x H 628 x 428 x 50 mm

Load (max.) 70 kg

Colour **Blue** **Grey**

Order no. 35544* 35545*

T09 VS01 PP with 6 holes for liftingColour **Blue** **Grey**

Order no. 35534* 35535*

T09 VS02 PPL conductive modelColour **Black, conductive**

Order no. 35548*

T09 VS01 PPL conductive modelColour **Black, conductive**

Order no. 35538*

720 x 520 x 73 mm

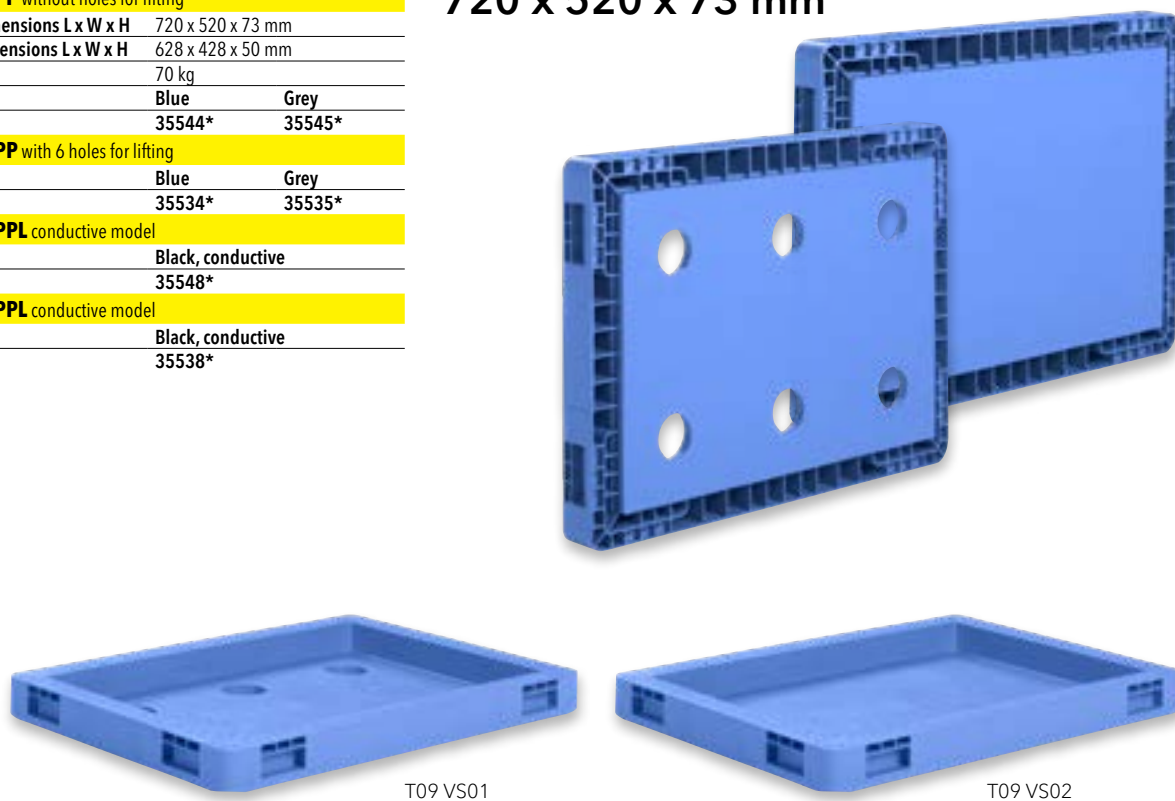

T09 VS01

T09 VS02

T10 VS02 PP without holes for lifting

External dimensions L x W x H 660 x 460 x 73 mm

Internal dimensions L x W x H 628 x 428 x 50 mm

Load (max.) 70 kg

Colour **Blue** **Grey**

Order no. 35564* 35565*

T10 VS01 PP with 6 holes for liftingColour **Blue** **Grey**

Order no. 35554* 35555*

T10 VS02 PPL conductive modelColour **Black, conductive**

Order no. 35568*

T10 VS01 PPL conductive modelColour **Black, conductive**

Order no. 35558*

660 x 460 x 73 mm

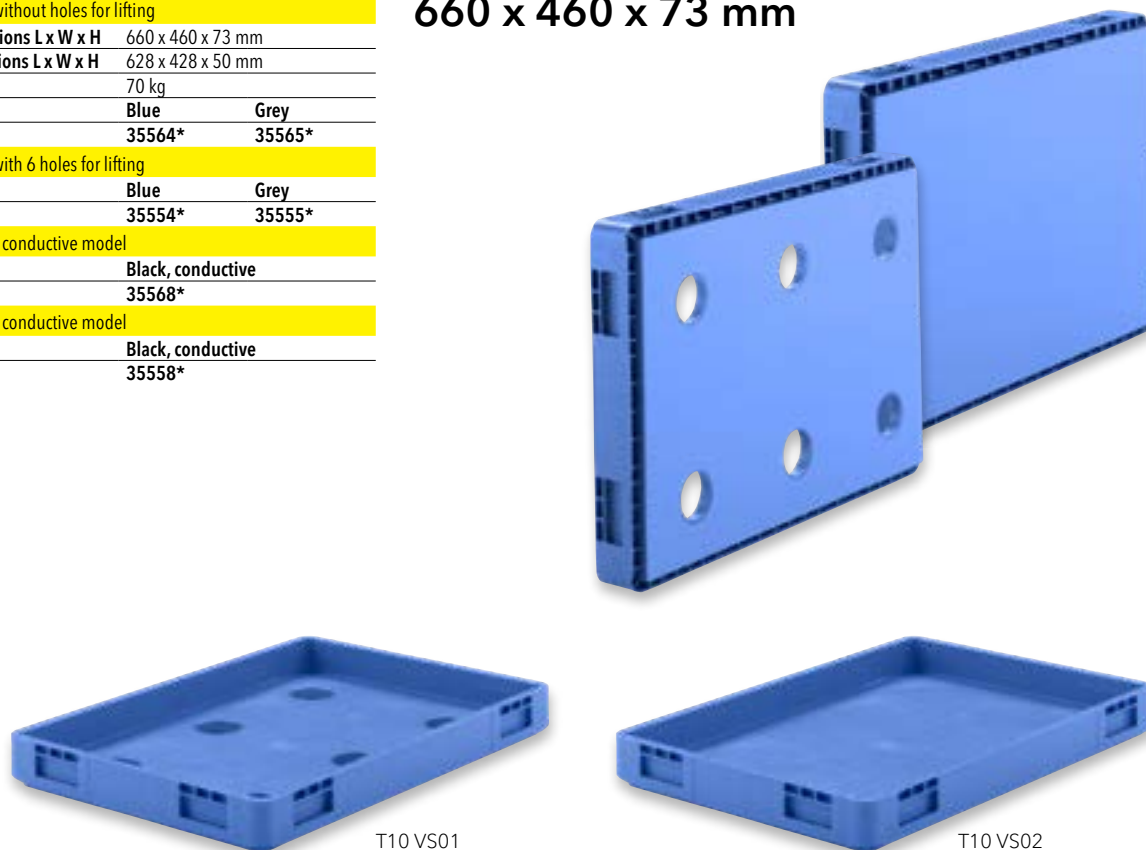

T10 VS01

T10 VS02

T range

720 x 460 x 73 mm

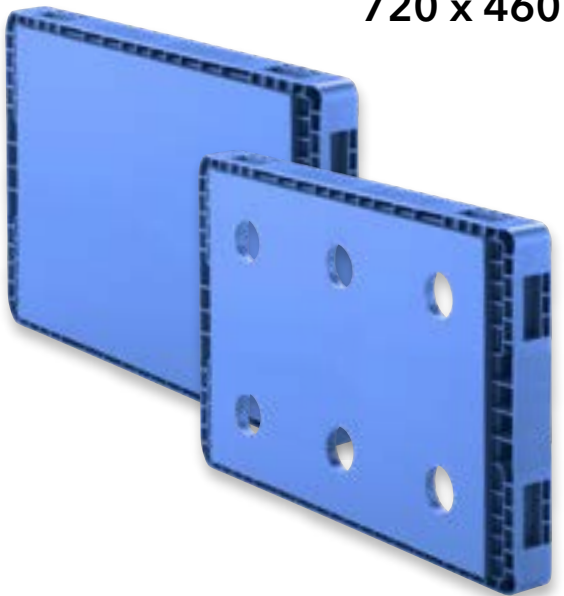

T11 VS02



T11 VS01

T11 VS02 PP without holes for lifting

External dimensions L x W x H	720 x 460 x 73 mm	
Internal dimensions L x W x H	628 x 428 x 50 mm	
Load (max.)	70 kg	
Colour	Blue	Grey
Order no.	35584*	35585*

T11 VS01 PP with 6 holes for lifting

Colour	Blue	Grey
Order no.	35574*	35575*

T11 VS02 PPL conductive model

Colour	Black, conductive	
Order no.	35588*	

T11 VS01 PPL conductive model

Colour	Black, conductive	
Order no.	35578*	

660 x 520 x 73 mm

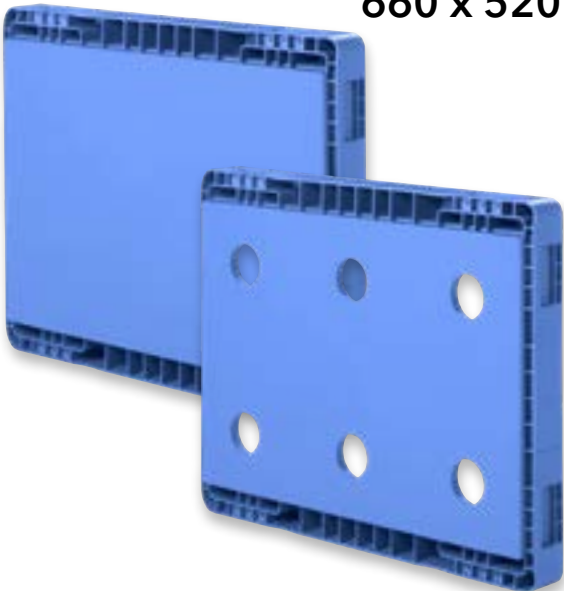

T12 VS02

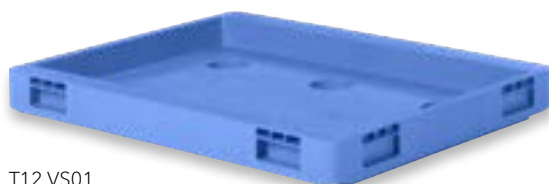

T12 VS01

T12 VS02 PP without holes for lifting

External dimensions L x W x H	660 x 520 x 73 mm	
Internal dimensions L x W x H	628 x 428 x 50 mm	
Load (max.)	70 kg	
Colour	Blue	Grey
Order no.	35604*	35605*

T12 VS01 PP with 6 holes for lifting

Colour	Blue	Grey
Order no.	35594*	35595*

T12 VS02 PPL conductive model

Colour	Black, conductive	
Order no.	35608*	

T12 VS01 PPL conductive model

Colour	Black, conductive	
Order no.	35598*	

T86082 VS01 PP

External dimensions L x W x H 830 x 630 x 82 mm

Internal dimensions L x W x H 801 x 601 x 59 mm

Load (max.) 70 kg

Colour Blue Grey

Order no. 25394* 25395*

T86082 VS01 PPL conductive model

Colour Black, conductive

Order no. 25398*

830 x 630 x 82 mm



LTB-T range

640 x 440 x 82 mm



LTB-T6444082 VS02

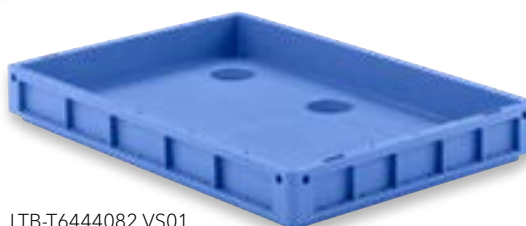

LTB-T6444082 VS01

LTB-T6444082 VS02 PP without holes for lifting

External dimensions L x W x H 640 x 440 x 82 mm

Internal dimensions L x W x H 611 x 411 x 60 mm

Load (max.) 70 kg

Colour **Blue** **Grey**

Order no. 35524* 35525*

LTB-T6444082 VS01 PP with 6 holes for lifting

Colour **Blue** **Grey**

Order no. 35514* 35515*

LTB-T6444082 VS02 PPL conductive model

Colour **Black, conductive**

Order no. 35528*

LTB-T6444082 VS01 PPL conductive model

Colour **Black, conductive**

Order no. 35518*

Industry solutions
for the automotive industry

Containers for storing small parts

Space-saving containers

Containers for semi- and
fully automated systems

Storage & transport containers
for manual handling

Our expertise: Plastic containers

D

Space-saving containers

- **FK range** from page **D2**
- **KMB range** from page **D10**
- **EFB range** from page **D22**
- **FB range** from page **D26**
- **KS and POOLBOX special ranges** from page **D30**

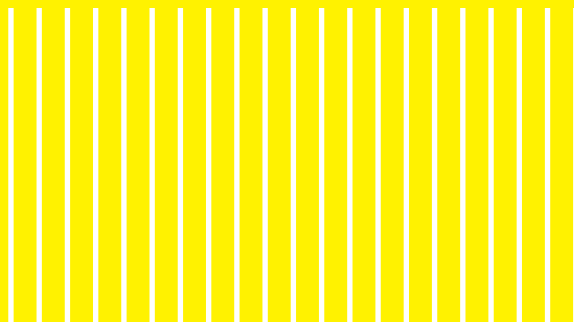

FK boxes - save space using folding & collapsing boxes

Greater transport capacity and less wasted space when transporting empties - this is what modern branch deliveries demand today. And that's exactly what our folding/collapsing boxes provide. Sturdy yet lightweight, the FK boxes reduce the volume by up to 80% when folded. This reduces fuel consumption and the volume of empties returned. At the same time, the variety of sizes means that the right box can be found for practically any type of cargo.

Whether in manual handling, in automated small parts warehouses or on conveyor lines, the container can be used anywhere without any problems. The containers can be stacked safely and are designed to match Euro pallet dimensions. Branch deliveries could hardly be more cost-efficient.

- 1| **Reinforced base rim**
for maximum stability
- 2| **Robust tunnel hinges**
for exceptional performance
- 3| **Ergonomic hand holes**
on short sides
- 4| **Torsion-resistant frame**
thanks to reinforcing elements

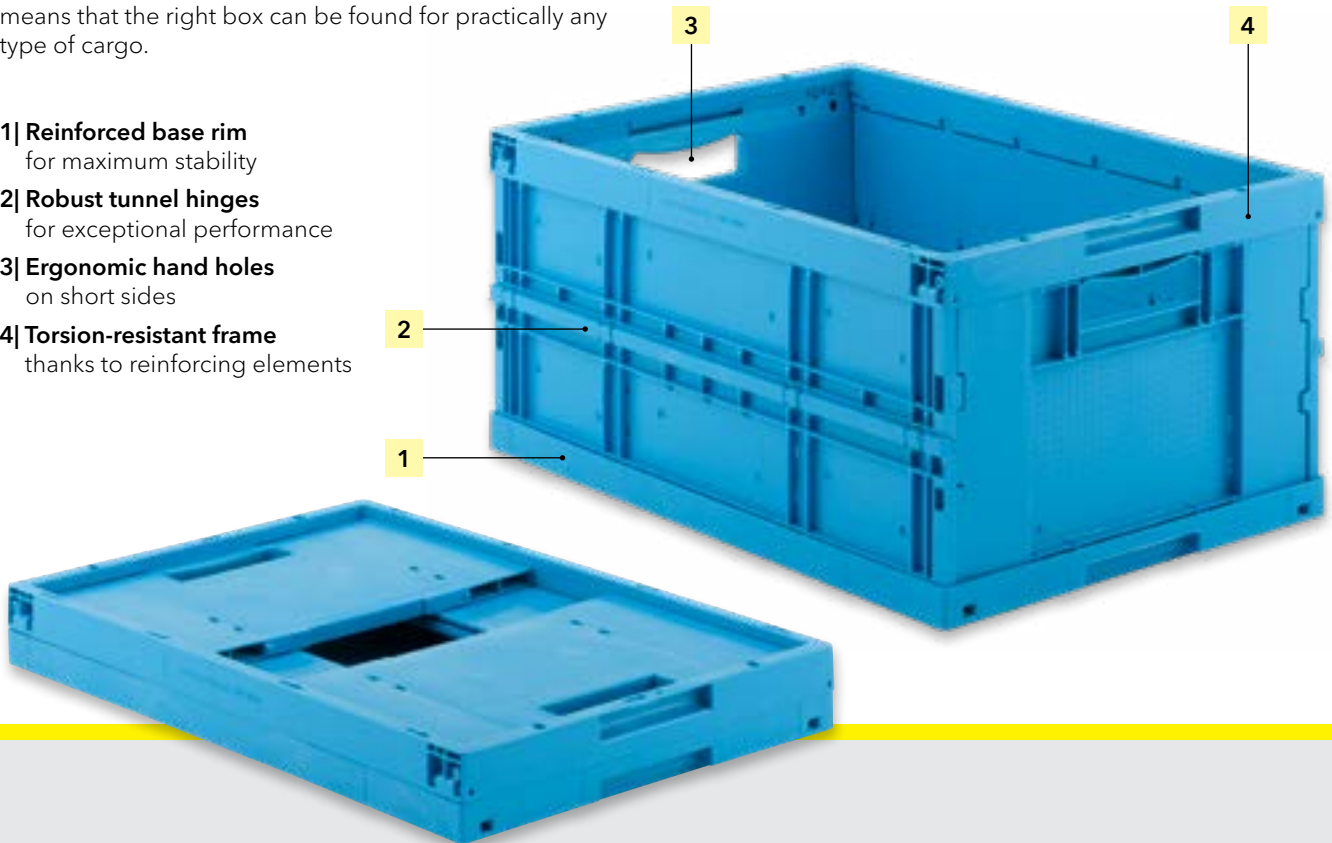

Ergonomic open grip

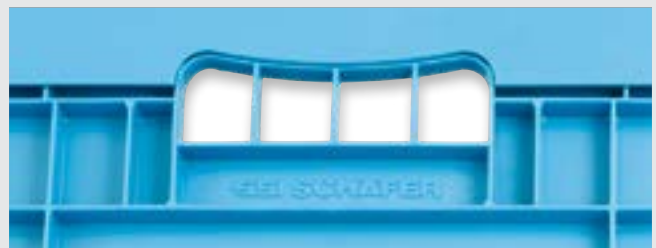

Anti-theft hand-hole



Single snap lock fastener



Fastener on base

Note: The fasteners and grips illustrated here are not available for all types of foldable-collapsible container (please see individual product images).



Key facts

- Fold and collapse to save space
- Savings when empty/collapsed:
 - 80% volume reduction
 - 80% less space required in the warehouse
 - 80% less lorry transport volume
- This translates to savings throughout the entire process:
 - lower warehousing costs
 - lower transport costs
 - lower CO₂ emissions

Typical customer applications

- Industry
- Automated small-parts warehouse storage containers
- Transport containers or pool/circulation containers to other warehouses, suppliers, shops, etc.

Smooth standard base
(max. load 20 kg)

VB3 ribbed base
(max. load 35 kg)

VB4 reinforced base
(max. load 35 kg)

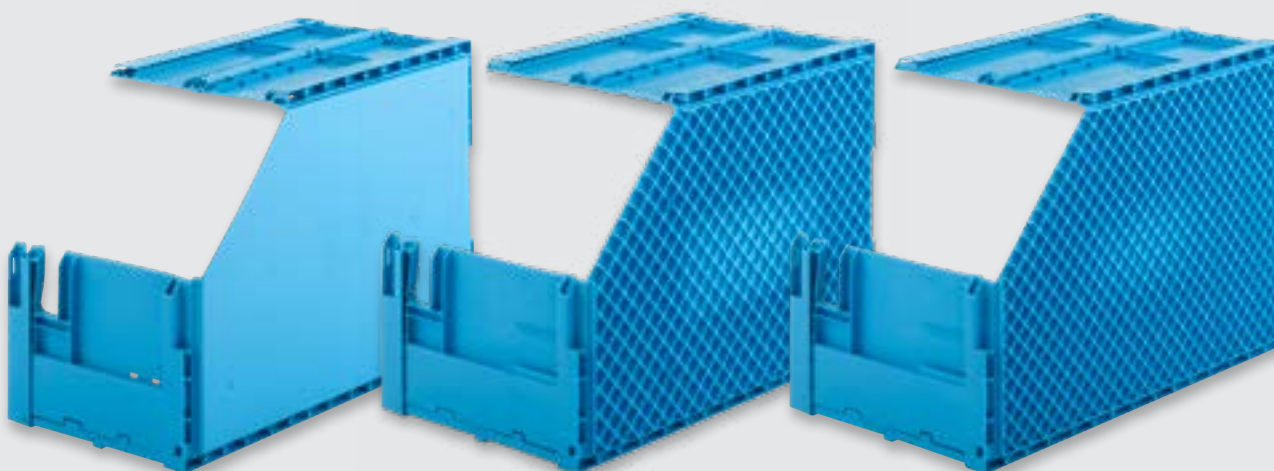

Standard colours:



With single snap lock fastener

600 x 400 x 285 mm



FKE 6285 PP		
External dimensions L x W x H	599 x 399 x 285 mm	
Internal dimensions L x W x H	564 x 369 x 282 mm	
Usable height when stacked	272 mm	
Height when folded (individual)	79 mm	
Height when folded (stacked)	69 mm	
Capacity	57.0 litres	
Load (max.)	20 kg	
Colour	Blue	Grey
Order no.	93684	93685
FKE-D 6285 with lid		
External dimensions L x W x H	599 x 399 x 297 mm	
Height when folded (individual)	91 mm	
Height when folded (stacked)	71 mm	
Colour	Blue	Grey
Order no.	93694*	93695*
FKE 6285 VB4 PP with reinforced base		
External dimensions L x W x H	599 x 399 x 285 mm	
Internal dimensions L x W x H	564 x 369 x 272 mm	
Usable height when stacked	262 mm	
Capacity	54.2 litres	
Load (max.)	35 kg	
Colour	Blue	Grey
Order no.	91764*	91765*
FKE-D 6285 VB4 PP with lid		
External dimensions L x W x H	599 x 399 x 297 mm	
Height when folded (individual)	91 mm	
Height when folded (stacked)	71 mm	
Colour	Blue	Grey
Order no.	91774	91775

600 x 400 x 320 mm



FKE 6320-2 PP		
External dimensions L x W x H	599 x 399 x 320 mm	
Internal dimensions L x W x H	564 x 369 x 317 mm	
Usable height when stacked	307 mm	
Height when folded (individual)	79 mm	
Height when folded (stacked)	69 mm	
Capacity	65.0 litres	
Load (max.)	20 kg	
Colour	Blue	Grey
Order no.	90404	90405
FKE-D 6320-2 PP with lid		
External dimensions L x W x H	599 x 399 x 332 mm	
Height when folded (individual)	91 mm	
Height when folded (stacked)	71 mm	
Colour	Blue	Grey
Order no.	90424	90425
FKE 6320-2 VB4 PP with reinforced base		
External dimensions L x W x H	599 x 399 x 320 mm	
Internal dimensions L x W x H	564 x 369 x 307 mm	
Usable height when stacked	297 mm	
Capacity	61.4 litres	
Load (max.)	35 kg	
Colour	Blue	Grey
Order no.	90414*	90415*
FKE-D 6320-2 VB4 PP with lid		
External dimensions L x W x H	599 x 399 x 332 mm	
Height when folded (individual)	91 mm	
Height when folded (stacked)	71 mm	
Colour	Blue	Grey
Order no.	90434*	90435*

With fastener at bottom

800 x 600 x 320 mm

FK 8320 PP with reinforced base

External dimensions L x W x H	798 x 598 x 320 mm	
Internal dimensions L x W x H	750 x 550 x 304 mm	
Usable height when stacked	291 mm	
Height when folded (individual)	135 mm	
Height when folded (stacked)	123 mm	
Capacity	126 Litres	
Load (max.)	30 kg	
Colour	Blue	Grey
Order no.	9264*	9265*

FK-DL 8320 PP with lid hinged on the long side

External dimensions L x W x H	798 x 598 x 320 mm	
Height when folded (individual)	135 mm	
Height when folded (stacked)	126 mm	
Colour	Blue	Grey
Order no.	9294*	9285*

FK-DS 8320 PP with lid hinged on the short side

External dimensions L x W x H	798 x 598 x 320 mm	
Height when folded (individual)	135 mm	
Height when folded (stacked)	126 mm	
Colour	Blue	Grey
Order no.	9284*	9275*

FK 8320 VS01 PP with reinforced welded base

Internal dimensions L x W x H	750 x 550 x 299 mm	
Usable height when stacked	286 mm	
Load (max.)	70 kg	
Colour	Blue	Grey
Order no.	9384*	9385*



With fastener at bottom

800 x 600 x 450 mm



FK 8450 PP with reinforced base

External dimensions L x W x H 798 x 598 x 450 mm

Internal dimensions L x W x H 750 x 550 x 434 mm

Usable height when stacked 421 mm

Height when folded (individual) 135 mm

Height when folded (stacked) 123 mm

Capacity 180.0 litres

Load (max.) 30 kg

Colour **Blue** **Grey**

Order no. **93364** **93365***

FK-DL 8450 PP with lid hinged on the long side

External dimensions L x W x H 798 x 598 x 450 mm

Height when folded (individual) 135 mm

Height when folded (stacked) 126 mm

Colour **Blue** **Grey**

Order no. **93474** **93475***

FK-DS 8450 PP with lid hinged on the short side

External dimensions L x W x H 798 x 598 x 450 mm

Height when folded (individual) 135 mm

Height when folded (stacked) 126 mm

Colour **Blue** **Grey**

Order no. **93464*** **93465***

FK 8450 VS01 PP with reinforced welded base

Internal dimensions L x W x H 750 x 550 x 429 mm

Usable height when stacked 416 mm

Load (max.) 70 kg

Colour **Blue** **Grey**

Order no. **9444*** **9445***

FR 8450 PP Foldable extension frame

External dimensions L x W x H 798 x 598 x 450 mm

Internal dimensions L x W x H 750 x 550 x 450 mm

Usable height when stacked 437 mm

Height when folded (individual) 135 mm

Height when folded (stacked) 123 mm

Colour **Blue** **Grey**Order no. **93614*** **93615*****FR-DL 8450 PP** with lid hinged on the long side

External dimensions L x W x H 798 x 598 x 450 mm

Height when folded (individual) 135 mm

Height when folded (stacked) 126 mm

Colour **Blue** **Grey**Order no. **93644*** **93645*****FR-DS 8450 PP** with lid hinged on the short side

External dimensions L x W x H 798 x 598 x 450 mm

Height when folded (individual) 135 mm

Height when folded (stacked) 126 mm

Colour **Blue** **Grey**Order no. **93654*** **93655***

800 x 600 x 450 mm



Dollies

Roll-Fix



Roll-Fix RO 460

RO 460 PP with plastic castors

For boxes	400 x 300 and 600 x 400 mm	
External dimensions L x W x H	594 x 396 x 150 mm	
Height of rim	15 mm	
Swivel castors Ø	80 mm	
Load capacity (max.)	200 kg	
Colour	Red	Grey
Order no.	22201	22205

RO 461 PP with solid rubber castors

Colour	Red	Grey
Order no.	22211	22215



Roll-Fix RO 461

Dolly



RLP 86 PP Dolly

External dimensions L x W x H	800 x 600 x 200 mm	
Stacking height (max.)	1,800 mm	
Height when stacked	130 mm	
Fork clearance	115 mm	
Swivel and fixed castors Ø	125 mm	
Load capacity (max.)	450 kg	
Colour	Black	
Order no.	93608	

Pallet covers

ADH 86 PP Pallet cover with banding notches and indentations for dollies

External dimensions L x W x H	814 x 614 x 44 mm
Height when stacked	30 mm
Colour	Black
Order no.	93628

Basic size 800 x 600 mm



KMB - a real space-saver

Eliminating the need for disposable packaging, we offer environmentally friendly reusable tapered reusable containers, which also provide a decisive increase in efficiency.

can be nested to take up 75 per cent less room. They can be automatically stacked and destacked from the long and short sides. And thanks to their simple form and smooth interiors, they are easy to clean.

The KMB makes incredibly efficient use of space. When empty, and with the bail arms folded down, the containers

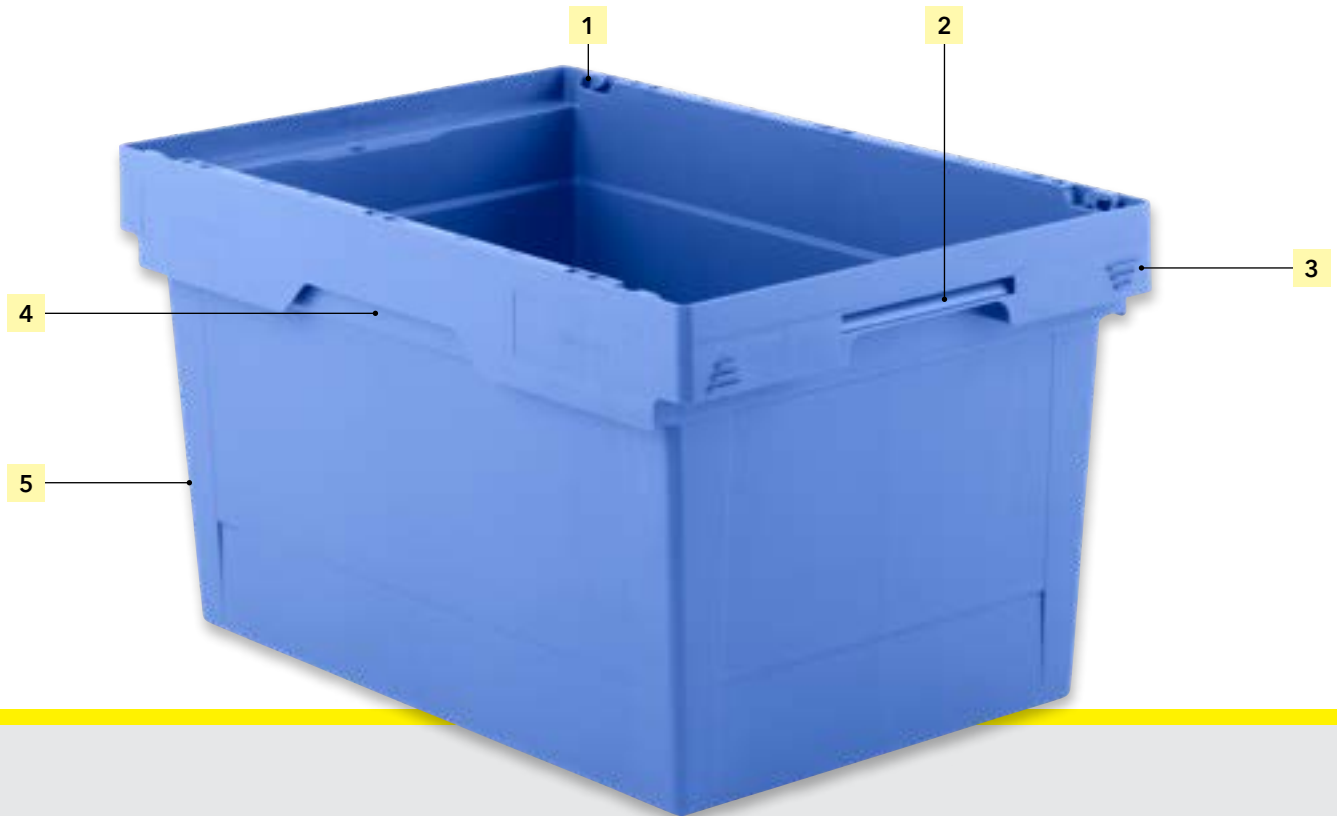

1| Bail arms
integrated in rim



2| Ergonomic hand holes
shaped to be gentle on the hands



3| Anti-lifting device
to prevent wedging on conveyor

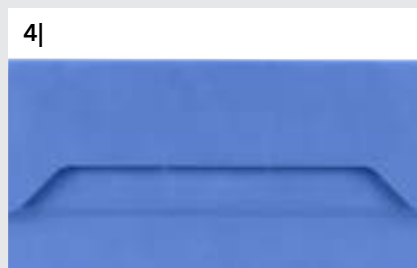

4| Grips for destacking
on long sides



5| Torsion-resistant design
with sturdy, moulded corners



Key facts

- Space-saving containers using nesting principle
- Cost savings in empty state/nested:
 - 75% reduction in volume
 - 75% less space required in warehouses
 - 75% less transport volume required in lorries
- Means cost savings right down the line:
 - lower warehousing costs
 - lower transport costs
 - lower CO₂ emissions

Typical customer applications

- Pool and reusable containers
- Manufacturer - supplier - recipient
- Storage containers for customers with limited storage space

Sustainability

- Considerable optimisation potential for procurement savings and process costs for reusable packaging
- Faster, easier filling
- Better and safer handling
- Higher load capacity
- Better, faster automation
- Safer transport
- Better protection of the contents
- Traceability by means of durable labelling
- No disposal costs (as for disposable packaging)
- 100% recyclable

Smooth base
(max. load 20 kg)

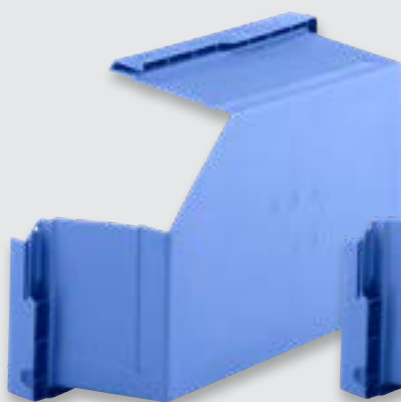

VB01 reinforced base
(max. load 50 kg)

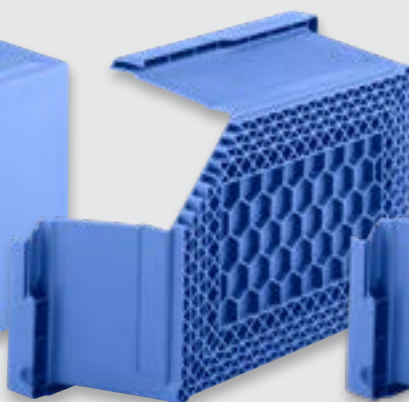

VS01 reinforced welded base
(max. load 70 kg)

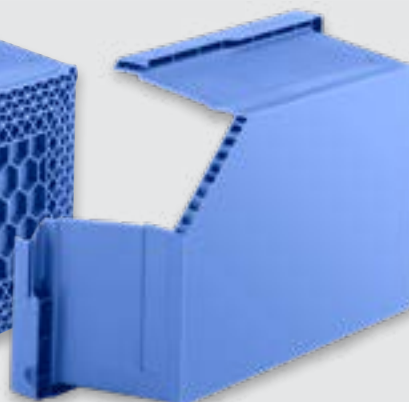

Standard colour:

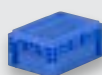

Different loads apply when the containers are stacked. Please contact us for more details.

Standard models

300 x 200 x 153 mm



KS 3153 PP

External dimensions top/bottom L x W x H	299/245 x 199/153 x 153 mm
Internal dimensions L x W x H	242 x 150 x 150 mm
Capacity	6.3 litres
Load (max.)	5 kg
Colour	Blue
Order no.	16474

400 x 300 x 223 mm



KMB 422 PP

External dimensions top/bottom L x W x H	399/320 x 299/240 x 223 mm
External dimensions with anti-lifting device L x W	407 x 299 mm
Internal dimensions L x W x H	315 x 235 x 220 mm
Capacity	18.0 litres
Load (max.)	15 kg
Colour	Blue
Order no.	75514

600 x 400 x 103 mm



KMB 610 PP

External dimensions top/bottom L x W x H	599/505 x 399/335 x 103 mm
External dimensions with anti-lifting device L x W	607 x 399 mm
Internal dimensions L x W x H	500 x 330 x 100 mm
Capacity	18.0 litres
Load (max.)	20 kg
Colour	Blue
Order no.	79324*

KMB 617 PP

External dimensions top/bottom L x W x H 599/505 x 399/335 x 173 mm

External dimensions with anti-lifting device
L x W 607 x 399 mm

Internal dimensions L x W x H 500 x 330 x 170 mm

Capacity 29.0 litres

Load (max.) 20 kg

Colour **Blue**Order no. **75364****KMB 617 VB01 PP with reinforced base**

External dimensions top/bottom L x W x H 599/505 x 399/335 x 192 mm

Load (max.) 50 kg

Colour **Blue**Order no. **75394*****600 x 400 x 173 mm****KMB 622 PP**

External dimensions top/bottom L x W x H 599/505 x 399/335 x 223 mm

External dimensions with anti-lifting device
L x W 607 x 399 mm

Internal dimensions L x W x H 500 x 330 x 220 mm

Capacity 38.0 litres

Load (max.) 20 kg

Colour **Blue**Order no. **75544****KMB 622 VB01 PP with reinforced base**

External dimensions top/bottom L x W x H 599/505 x 399/335 x 242 mm

Load (max.) 50 kg

Colour **Blue**Order no. **75574*****600 x 400 x 223 mm****KMB 627 PP**

External dimensions top/bottom L x W x H 599/505 x 399/335 x 273 mm

External dimensions with anti-lifting device
L x W 607 x 399 mm

Internal dimensions L x W x H 500 x 330 x 270 mm

Capacity 47.0 litres

Load (max.) 20 kg

Colour **Blue**Order no. **75424****KMB 627 VB01 PP with reinforced base**

External dimensions top/bottom L x W x H 599/505 x 399/335 x 292 mm

Load (max.) 50 kg

Colour **Blue**Order no. **75454*****KMB 627 VS01 PP with reinforced welded base**

External dimensions top/bottom L x W x H 599/505 x 399/335 x 273 mm

Internal dimensions L x W x H 500 x 330 x 250 mm

Capacity 44.0 litres

Load (max.) 70 kg

Colour **Blue**Order no. **74974*****600 x 400 x 273 mm**

Standard models

600 x 400 x 323 mm



KMB 632 PP

External dimensions top/bottom L x W x H 599/505 x 399/335 x 323 mm

External dimensions with anti-lifting device L x W 607 x 399 mm

Internal dimensions L x W x H 500 x 330 x 320 mm

Capacity 58.0 litres

Load (max.) 20 kg

Colour Blue

Order no. 75604

KMB 632 VB01 PP with reinforced base

External dimensions top/bottom L x W x H 599/505 x 399/335 x 342 mm

Load (max.) 50 kg

Colour Blue

Order no. 75634*

600 x 400 x 423 mm



KMB 642 PP

External dimensions top/bottom L x W x H 599/505 x 399/335 x 423 mm

External dimensions with anti-lifting device L x W 607 x 399 mm

Internal dimensions L x W x H 500 x 330 x 420 mm

Capacity 74.0 litres

Load (max.) 20 kg

Colour Blue

Order no. 75924

KMB 642 VB01 PP with reinforced base

External dimensions top/bottom L x W x H 599/505 x 399/335 x 442 mm

Load (max.) 50 kg

Colour Blue

Order no. 75954*

800 x 400 x 323 mm



KMB 832 PP

External dimensions top/bottom L x W x H 799/705 x 399/335 x 323 mm

External dimensions with anti-lifting device L x W 807 x 399 mm

Internal dimensions L x W x H 700 x 330 x 320 mm

Capacity 76.0 litres

Load (max.) 20 kg

Colour Blue

Order no. 75664

With bail arms

KMB-B 422 PP with 2 bail arms KMB-B 300

External dimensions top/bottom L x W x H	399/320 x 299/240 x 223 mm
External dimensions with anti-lifting device L x W	407 x 299 mm
Internal dimensions L x W x H	315 x 235 x 220 mm
Usable height when stacked	218 mm
Capacity	18.0 litres
Load (max.)	15 kg
Colour	Blue
Order no.	75524

400 x 300 x 223 mm

**KMB-B 610 PP** with 2 bail arms KMB-B 400

External dimensions top/bottom L x W x H	599/505 x 399/335 x 103 mm
External dimensions with anti-lifting device L x W	607 x 399 mm
Internal dimensions L x W x H	500 x 330 x 100 mm
Usable height when stacked	98 mm
Capacity	18.0 litres
Load (max.)	20 kg
Colour	Blue
Order no.	79334*

600 x 400 x 103 mm

**KMB-B 617 PP** with 2 bail arms KMB-B 400

External dimensions top/bottom L x W x H	599/505 x 399/335 x 173 mm
External dimensions with anti-lifting device L x W	607 x 399 mm
Internal dimensions L x W x H	500 x 330 x 170 mm
Usable height when stacked	168 mm
Capacity	29.0 litres
Load (max.)	20 kg
Colour	Blue
Order no.	75374

600 x 400 x 173 mm

**KMB 617 VB01 PP** with reinforced base

External dimensions top/bottom L x W x H	599/505 x 399/335 x 192 mm
Load (max.)	50 kg
Colour	Blue
Order no.	75404*

With bail arms

600 x 400 x 223 mm



KMB-B 622 PP with 2 bail arms KMB-B 400

External dimensions top/bottom L x W x H 599/505 x 399/335 x 223 mm

External dimensions with anti-lifting device L x W 607 x 399 mm

Internal dimensions L x W x H 500 x 330 x 220 mm

Usable height when stacked 208 mm

Capacity 38.0 litres

Load (max.) 20 kg

Colour **Blue**

Order no. **75554**

KMB 622 VB01 PP with reinforced base

External dimensions top/bottom L x W x H 599/505 x 399/335 x 242 mm

Load (max.) 50 kg

Colour **Blue**

Order no. **75584***

600 x 400 x 273 mm



KMB-B 627 PP with 2 bail arms KMB-B 400

External dimensions top/bottom L x W x H 599/505 x 399/335 x 273 mm

External dimensions with anti-lifting device L x W 607 x 399 mm

Internal dimensions L x W x H 500 x 330 x 270 mm

Usable height when stacked 268 mm

Capacity 47.0 litres

Load (max.) 20 kg

Colour **Blue**

Order no. **75434**

KMB-B 627 VB01 PP with reinforced base

External dimensions top/bottom L x W x H 599/505 x 399/335 x 292 mm

Load (max.) 50 kg

Colour **Blue**

Order no. **75464***

KMB-B 627 VS01 PP with reinforced welded base

External dimensions top/bottom L x W x H 599/505 x 399/335 x 273 mm

Internal dimensions L x W x H 500 x 330 x 250 mm

Usable height when stacked 248 mm

Capacity 44.0 litres

Load (max.) 70 kg

Colour **Blue**

Order no. **74984***

600 x 400 x 323 mm



KMB-B 632 PP with 2 bail arms KMB-B 400

External dimensions top/bottom L x W x H 599/505 x 399/335 x 323 mm

External dimensions with anti-lifting device L x W 607 x 399 mm

Internal dimensions L x W x H 500 x 330 x 320 mm

Usable height when stacked 318 mm

Capacity 58.0 litres

Load (max.) 20 kg

Colour **Blue**

Order no. **75614**

KMB-B 632 VB01 PP with reinforced base

External dimensions top/bottom L x W x H 599/505 x 399/335 x 342 mm

Load (max.) 50 kg

Colour **Blue**

Order no. **75644***

KMB-B 642 PP with 2 bail arms KMB-B 400

External dimensions top/bottom L x W x H 599/505 x 399/335 x 423 mm

External dimensions with anti-lifting device
L x W 607 x 399 mm

Internal dimensions L x W x H 500 x 330 x 420 mm

Usable height when stacked 418 mm

Capacity 74.0 litres

Load (max.) 20 kg

Colour **Blue**Order no. **75934****KMB-B 642 VB01 PP** with reinforced base

External dimensions top/bottom L x W x H 599/505 x 399/335 x 442 mm

Load (max.) 50 kg

Colour **Blue**Order no. **75964*****600 x 400 x 423 mm****KMB-B 832 PP** with 2 bail arms KMB-B 400

External dimensions top/bottom L x W x H 799/705 x 399/335 x 323 mm

External dimensions with anti-lifting device
L x W 807 x 399 mm

Internal dimensions L x W x H 700 x 330 x 320 mm

Usable height when stacked 318 mm

Capacity 76.0 litres

Load (max.) 20 kg

Colour **Blue**Order no. **75674****800 x 400 x 323 mm**

With two-part hinged lids

400 x 300 x 257 mm



KMB-DH 422 PP with two-part hinged lid

External dimensions top/bottom L x W x H	409/320 x 299/240 x 257 mm
External dimensions with anti-lifting device L x W	409 x 299 mm
Internal dimensions L x W x H	315 x 235 x 213 mm
Usable height when stacked	213 mm
Capacity	18.0 litres
Load (max.)	15 kg
Colour	Blue
Order no.	75534

600 x 400 x 137 mm



KMB-DH 610 PP with two-part hinged lid

External dimensions top/bottom L x W x H	609/505 x 399/335 x 137 mm
External dimensions with anti-lifting device L x W	609 x 399 mm
Internal dimensions L x W x H	500 x 330 x 93 mm
Usable height when stacked	92 mm
Capacity	18.0 litres
Load (max.)	20 kg
Colour	Blue
Order no.	79344*

600 x 400 x 207 mm



KMB-DH 617 PP with two-part hinged lid

External dimensions top/bottom L x W x H	609/505 x 399/335 x 207 mm
External dimensions with anti-lifting device L x W	609 x 399 mm
Internal dimensions L x W x H	500 x 330 x 163 mm
Usable height when stacked	162 mm
Capacity	29.0 litres
Load (max.)	20 kg
Colour	Blue
Order no.	75384

KMB-DH 617 VB01 PP with reinforced base

External dimensions top/bottom L x W x H	609/505 x 399/335 x 226 mm
Load (max.)	50 kg
Colour	Blue
Order no.	75414*

KMB-DH 622 PP with two-part hinged lid

External dimensions top/bottom L x W x H 609/505 x 399/335 x 257 mm

External dimensions with anti-lifting device
L x W 609 x 399 mm

Internal dimensions L x W x H 500 x 330 x 213 mm

Usable height when stacked 212 mm

Capacity 38.0 litres

Load (max.) 20 kg

Colour **Blue**Order no. **75564****KMB-DH 622 VB01 PP** with reinforced base

External dimensions top/bottom L x W x H 609/505 x 399/335 x 276 mm

Load (max.) 50 kg

Colour **Blue**Order no. **75594*****600 x 400 x 257 mm****KMB-DH 627 PP** with two-part hinged lid

External dimensions top/bottom L x W x H 609/505 x 399/335 x 307 mm

External dimensions with anti-lifting device
L x W 609 x 399 mm

Internal dimensions L x W x H 500 x 330 x 263 mm

Usable height when stacked 262 mm

Capacity 47.0 litres

Load (max.) 20 kg

Colour **Blue**Order no. **75444****KMB-DH 627 VB01 PP** with reinforced base

External dimensions top/bottom L x W x H 609/505 x 399/335 x 326 mm

Load (max.) 50 kg

Colour **Blue**Order no. **75474*****KMB-DH 627 VS01 PP** with reinforced welded base

External dimensions top/bottom L x W x H 609/505 x 399/335 x 307 mm

Internal dimensions L x W x H 500 x 330 x 263 mm

Usable height when stacked 243 mm

Capacity 44.0 litres

Load (max.) 70 kg

Colour **Blue**Order no. **74994*****600 x 400 x 307 mm****KMB-DH 632 PP** with two-part hinged lid

External dimensions top/bottom L x W x H 609/505 x 399/335 x 357 mm

External dimensions with anti-lifting device
L x W 609 x 399 mm

Internal dimensions L x W x H 500 x 330 x 313 mm

Usable height when stacked 312 mm

Capacity 58.0 litres

Load (max.) 20 kg

Colour **Blue**Order no. **75624****KMB-DH 632 VB01 PP** with reinforced base

External dimensions top/bottom L x W x H 609/505 x 399/335 x 376 mm

Load (max.) 50 kg

Colour **Blue**Order no. **75654*****600 x 400 x 357 mm**

With two-part hinged lids

600 x 400 x 457 mm



KMB-DH 642 PP with two-part hinged lid

External dimensions top/bottom L x W x H 609/505 x 399/335 x 457 mm

External dimensions with anti-lifting device L x W 609 x 399 mm

Internal dimensions L x W x H 500 x 330 x 413 mm

Usable height when stacked 412 mm

Capacity 74.0 litres

Load (max.) 20 kg

Colour **Blue**

Order no. **75944**

KMB-DH 642 VB01 PP with reinforced base

External dimensions top/bottom L x W x H 609/505 x 399/335 x 476 mm

Load (max.) 50 kg

Colour **Blue**

Order no. **75974***

800 x 400 x 357 mm



KMB-DH 832 PP with two-part hinged lid

External dimensions top/bottom L x W x H 809/705 x 399/335 x 357 mm

External dimensions with anti-lifting device L x W 809 x 399 mm

Internal dimensions L x W x H 700 x 330 x 312 mm

Usable height when stacked 311 mm

Capacity 76.0 litres

Load (max.) 20 kg

Colour **Blue**

Order no. **75684**

Lids

KS-D 3153 PP with film hinges and snap hooks,
collapsible

Colour	Blue
Order no.	16484

Basic size 300 x 200 mm

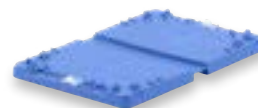

KMB-D 43 PP

Colour	Blue
Order no.	75344

Basic size 400 x 300 mm



KMB-D 64 PP

Colour	Blue
Order no.	75354

Basic size 600 x 400 mm

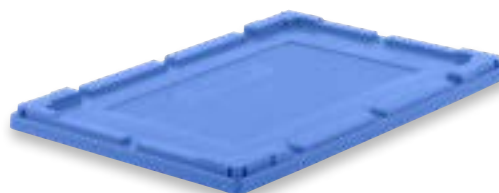

KMB-D 84 PP

Colour	Blue
Order no.	75334

Basic size 800 x 400 mm



EFB - stack and nest containers

EUROFIX boxes enable both the saving of space and the reduction of warehouse costs. Since they can be quickly turned through 180 degrees, the EFB containers can be stacked when full and nested when empty. In this way, they take up around 75% less space on empty return journeys or when not in use. EFB containers of any height can be stacked together.

Our EFB is very sturdy and robust, making it suitable for demanding industrial applications. In addition, the EFB is suitable both for automated conveyor systems and manual handling, ensuring efficiency.

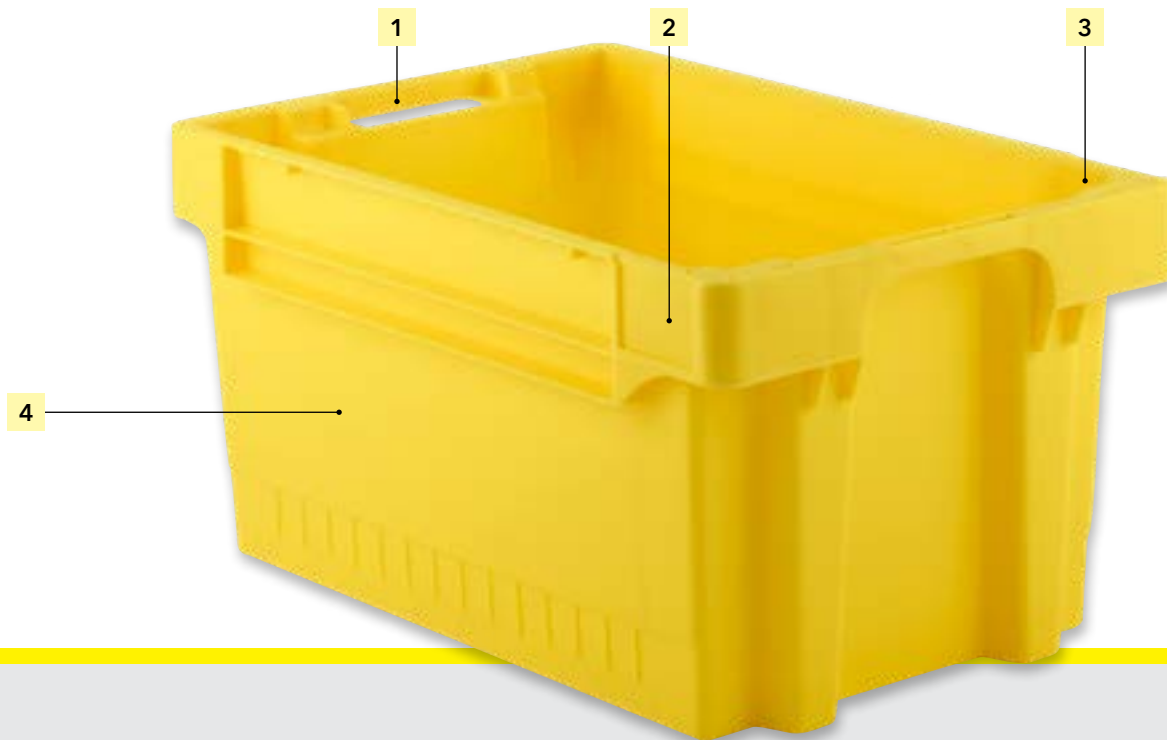

1| Ergonomic hand holes
shaped to be gentle on the hands



2| Barcode and label holders
can be incorporated in various places



3| Moulded short side
for stacking and nesting



4| Large area
for hot stamping or labelling



Key facts

- A bestseller among the stack and nest container ranges
- Very sturdy and robust for a long service life
- 75% volume reduction when empty
- Simple handling
- Cost-effective

Typical customer applications

- Industry
- Mainly manual handling
- On conveyor systems
- With robotic handling
- Seasonal goods containers
- Reusable containers travel between facilities - for semi-finished goods, finishing processes etc.



180-degree stacking and nesting containers: rotate to stack into or on top of each other



Standard colours:



EUROFIX boxes...

600 x 400 x 200 mm



EFB 642 PP Base and walls solid				
External dimensions top/bottom L x W x H	600/479 x 400/332 x 200 mm			
Internal dimensions top/bottom L x W x H	504/472 x 363/325 x 196 mm			
Usable height when stacked	178 mm			
Capacity	36.0 litres			
Load (max.)	20 kg			
Colour	Red	Green	Yellow	Blue
Order no.	25801*	25802*	25803*	25804*
EFB-L 642 PP Solid base, walls perforated				
Load (max.)	20 kg			
Colour	Red	Green	Yellow	Blue
Order no.	25911*	25912*	25913*	25914*
EFB-B 642 PP Base perforated, walls solid				
Load (max.)	15 kg			
Colour	Red	Green	Yellow	Blue
Order no.	25941*	25942*	25943*	25944*
EFB-LB 642 PP Base and walls perforated				
Load (max.)	15 kg			
Colour	Red	Green	Yellow	Blue
Order no.	25971*	25972*	25973*	25974*

600 x 400 x 280 mm



EFB 64280 PP Base and walls solid				
External dimensions top/bottom L x W x H	600/479 x 400/332 x 280 mm			
Internal dimensions top/bottom L x W x H	504/472 x 363/325 x 277 mm			
Usable height when stacked	258.5 mm			
Capacity	46.5 litres			
Load (max.)	20 kg			
Colour	Red	Green	Yellow	Blue
Order no.	56081*	56082*	56083*	56084*

600 x 400 x 300 mm



EFB 643 PP Base and walls solid				
External dimensions top/bottom L x W x H	600/479 x 400/332 x 300 mm			
Internal dimensions top/bottom L x W x H	504/472 x 363/325 x 296 mm			
Usable height when stacked	278 mm			
Capacity	54.0 litres			
Load (max.)	20 kg			
Colour	Red	Green	Yellow	Blue
Order no.	25831	25832	25833*	25834
EFB-L 643 PP Solid base, walls perforated				
Load (max.)	20 kg			
Colour	Red	Green	Yellow	Blue
Order no.	25921*	25922*	25923*	25924*
EFB-B 643 PP Base perforated, walls solid				
Load (max.)	15 kg			
Colour	Red	Green	Yellow	Blue
Order no.	25951*	25952*	25953*	25954*
EFB-LB 643 PP Base and walls perforated				
Load (max.)	15 kg			
Colour	Red	Green	Yellow	Blue
Order no.	25981*	25982*	25983*	25984*

... and lids

EFB 644 PP Base and walls solid

External dimensions top/bottom L x W x H	600/479 x 400/332 x 400 mm			
Internal dimensions top/bottom L x W x H	504/472 x 363/325 x 396 mm			
Usable height when stacked	378 mm			
Capacity	72.0 litres			
Load (max.)	20 kg			
Colour	Red	Green	Yellow	Blue
Order no.	25861	25862*	25863*	25864*

EFB-L 644 PP Solid base, walls perforated

Load (max.)	20 kg			
Colour	Red	Green	Yellow	Blue
Order no.	25931*	25932*	25933*	25934*

EFB-B 644 PP Base perforated, walls solid

Load (max.)	15 kg			
Colour	Red	Green	Yellow	Blue
Order no.	25961*	25962*	25963*	25964*

EFB-LB 644 PP Base and walls perforated

Load (max.)	15 kg			
Colour	Red	Green	Yellow	Blue
Order no.	25991*	25992*	25993*	25994*

600 x 400 x 400 mm



EFB-D PP lid with external open grips

for	all Euro Fix boxes			
Colour	Red	Green	Yellow	Blue
Order no.	25891*	25892*	25893*	25894

Basic size 600 x 400 mm



FB - stack and nest containers

The FB range was the first generation of our stack and nest container ranges and is still in demand today among our customers for light industrial applications.

Since they can be quickly turned through 180 degrees, the FB containers can be stacked when full and nested when empty. In the warehouse or in transit, they save 75% volume when nested.

The Fix-Box is the right load carrier when it comes to light but large-volume products that are transported by lorry or rail using manual handling.

Sturdy grips and rims enable uncomplicated, easy handling of the stack and nest containers. The containers can be stacked on top of each other with or without lids.

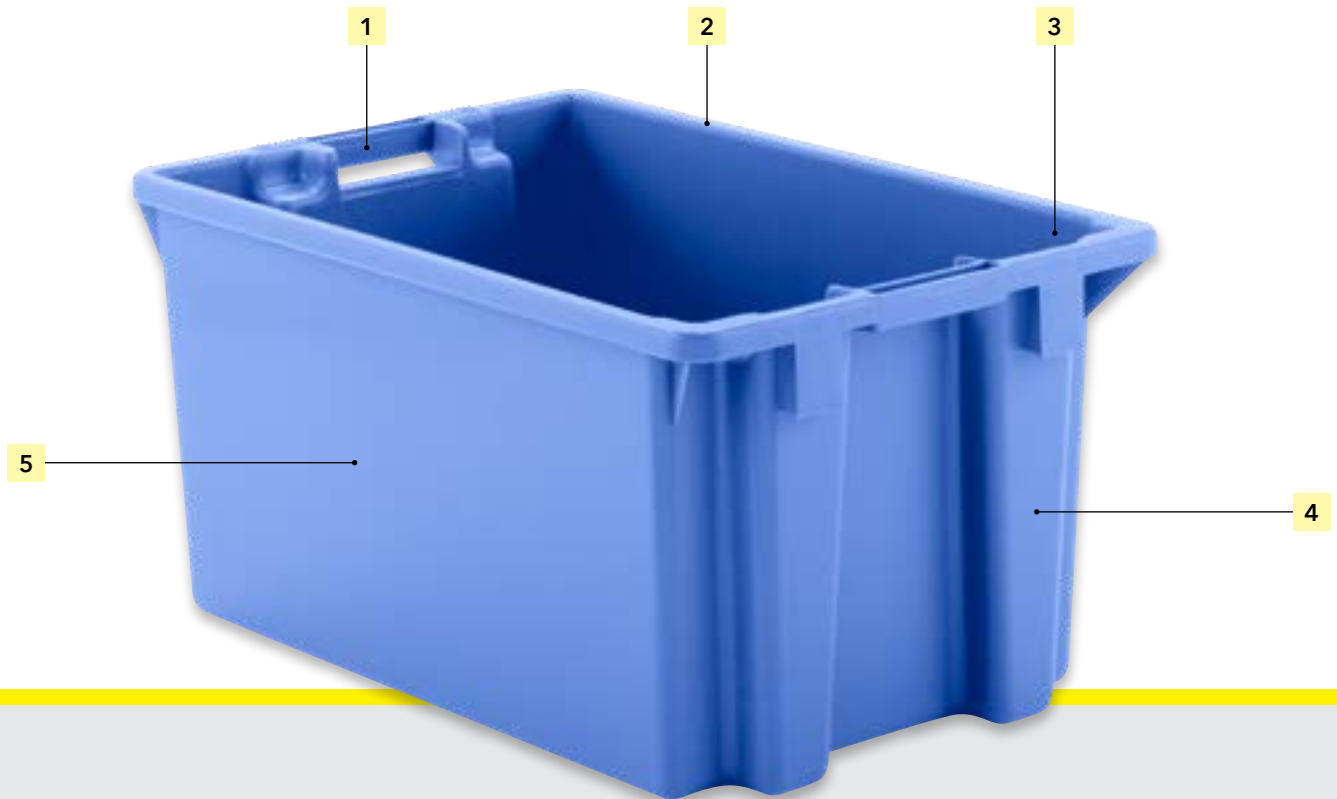

1| Ergonomic hand holes
shaped to be gentle on the hands



2| Sturdy rim
to prevent warping



3| Moulded short side
for stacking and nesting



4| Convex form
designed to slot into container below



5| Large surface
for hot stamping or labelling



Key facts

- Original generation of stack and nest containers
- Lightest range among the stack and nest containers
- 75% volume reduction when empty
- Convenient, easy handling
- Cost-effective

Typical customer applications

- Light industrial applications
- Manual applications
- In-plant use
- With lid also for external use

Our expertise: Plastic containers

Storage & transport containers for manual handling

Containers for semi- and fully automated systems

Space-saving containers

Containers for storing small parts

Industry solutions for the automotive industry

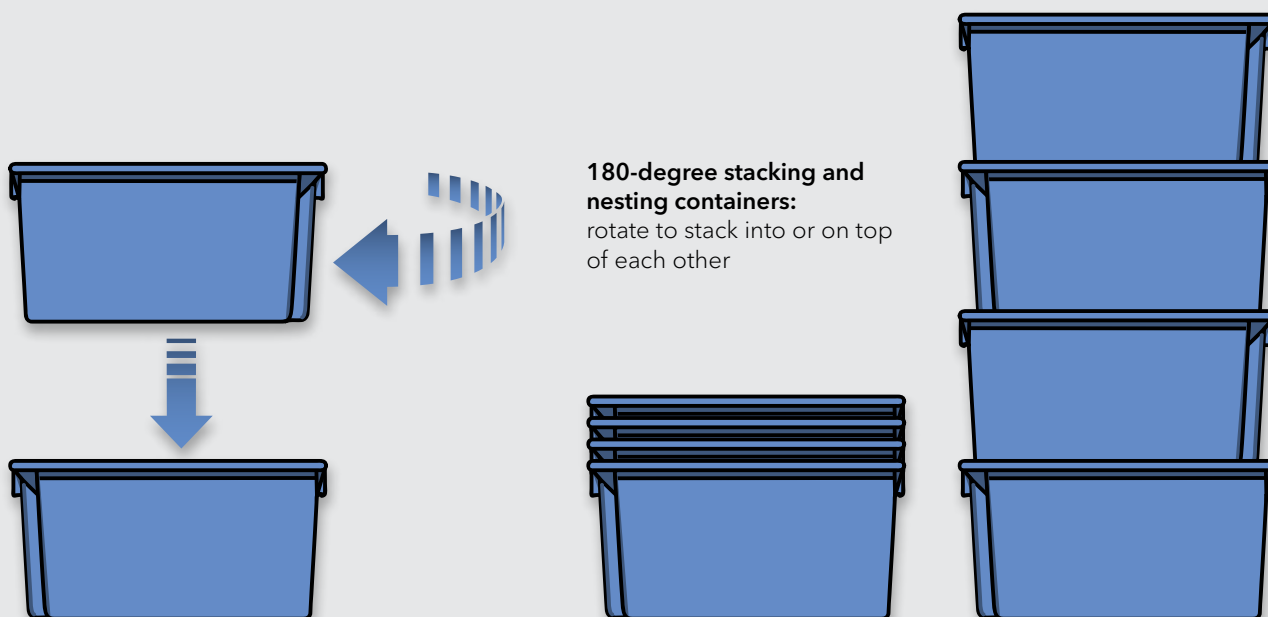

Standard colours:



Fix-Boxes

540 x 320 x 170 mm



FB 530 PP with recessed hand grips

External dimensions top/bottom L x W x H	540/431 x 320/262 x 170 mm			
Internal dimensions top/bottom L x W x H	420/425 x 275/255 x 167 mm			
Usable height when stacked	152 mm			
Capacity	17.0 litres			
Load (max.)	20 kg			
Colour	Red	Green	Yellow	Blue
Order no.	12471*	12472	12473*	12474

585 x 375 x 200 mm



FB 601 PP with recessed hand grips

External dimensions top/bottom L x W x H	585/463 x 375/310 x 200 mm			
Internal dimensions top/bottom L x W x H	490/420 x 330/300 x 196 mm			
Usable height when stacked	176 mm			
Capacity	30.0 litres			
Load (max.)	20 kg			
Colour	Red	Green	Yellow	Blue
Order no.	8441	8442	8443	8444

FB-D 601 PP lid with recessed hand grips

Colour	Grey			
Order no.	20905*			



600 x 400 x 250 mm



FB 600 PE with hand-grips moulded into the robust rim

External dimensions top/bottom L x W x H	600/509 x 400/333 x 250 mm			
Internal dimensions top/bottom L x W x H	550/500 x 360/325 x 247 mm			
Usable height when stacked	232 mm			
Capacity	40.0 litres			
Load (max.)	20 kg			
Colour	Red	Green	Yellow	Blue
Order no.	8351	8352	8353	8354

FB-D 600 PE lid with stacking corners

Colour	Red	Green	Yellow	Blue
Order no.	8361	8362	8363	8364

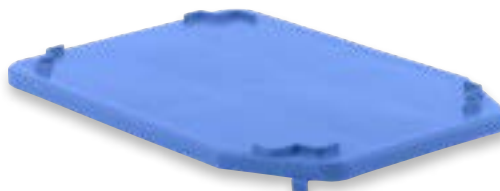

FB 603 PP with open grips on the short sides

External dimensions top/bottom L x W x H	597/542 x 397/340 x 300 mm			
Internal dimensions top/bottom L x W x H	565/530 x 364/334 x 297 mm			
Usable height when stacked	277 mm			
Capacity	57.0 litres			
Load (max.)	20 kg			
Colour	Red	Green	Yellow	Blue
Order no.	12481	12482*	12483*	12484

600 x 400 x 300 mm



FB 604 PP with open grips on the short sides

External dimensions top/bottom L x W x H	600/530 x 400/325 x 350 mm			
Internal dimensions top/bottom L x W x H	502/475 x 354/317 x 347 mm			
Usable height when stacked	332 mm			
Capacity	62.0 litres			
Load (max.)	20 kg			
Colour	Red	Green	Yellow	Blue
Order no.	8381*	8382*	8383*	8384

600 x 400 x 350 mm



FB-D 604 PP lid with stacking corners

Colour	Red	Green	Yellow	Blue
Order no.	15051	15052*	15053*	15054

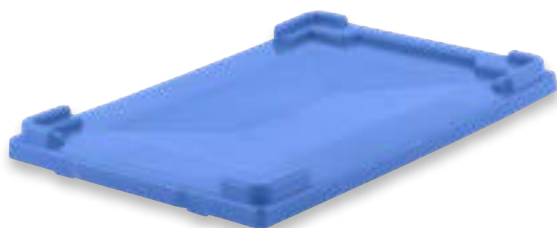

Our expertise: Plastic containers

Storage & transport containers for manual handling

Containers for semi- and fully automated systems

Space-saving containers

Containers for storing small parts

Industry solutions for the automotive industry

KS - special solutions

These are the result of special customer projects and are now available as an extended standard for customers interested in these solutions.



POOLBOX
with hook-on lid,
dust- and splash-proof



KS and POOLBOX tapered transport and order-picking containers can only be stacked on top of each other with lids on.

Standard colours:





Key facts

- Very sturdy and robust
- Very long service life
- For industrial applications

Typical customer applications

- Our KS 18 is often used as a removals container
- POOLBOX is used as a closed reusable container when the lid is firmly locked and protection against dust and dirt has to be guaranteed



KS 18
with label holders in rim
on both long sides



KS and POOLBOX

600 x 400 x 320 mm



PB-D 64

PB 6320 PP POOLBOX for conveyor systems, with ergonomic hand grips

External dimensions top/bottom L x W x H 598/524 x 398/324 x 314 mm

Internal dimensions top/bottom L x W x H 486/459 x 347/319 x 311 mm

Capacity 49.0 litres

Load (max.) 25 kg

Colour RAL 5012

Order no. 844

PB-D 64 PP lid suitable for crimp seal, with open grips through to container rim

Colour RAL 5012

Order no. 874

KS 18 PP with label holders in rim on both long sides

External dimensions top/bottom L x W x H	775/655 x 535/415 x 310 mm			
Internal dimensions top/bottom L x W x H	720/640 x 480/400 x 307 mm			
Label holder L x W	100 x 60 mm			
Capacity	90.0 litres			
Load (max.)	20 kg			
Colour	Red	Green	Yellow	Blue
Order no.	15171*	15172	15173	15174

KS-D 18 V1 PP lid with off-centre banding notches

Colour	Red	Green	Yellow	Blue
Order no.	15291*	15292	15293*	15294

KS-D 18 V2 PP lid with retaining rim for KS 51/KS 52

Colour	Red	Green	Yellow	Blue
Order no.	15271*	15272*	15273*	15274*

775 x 535 x 310 mm



KS-D 18

Our expertise: Plastic containers

Storage & transport containers for manual handling

Containers for semi- and fully automated systems

Space-saving containers

Containers for storing small parts

Industry solutions for the automotive industry

* = Article on request



Containers for storing small parts

- **LF range** from page **E2**
- **RK range** from page **E16**
- **Insert boxes for shelving and drawers** from page **E28**
- **Special range 14/6** from page **E30**

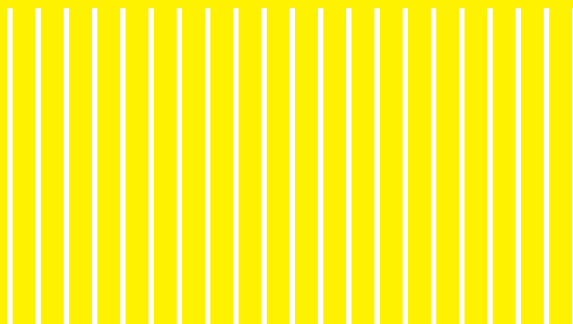

LF - for a clear overview

Our Lager-Fix containers, made of sturdy polypropylene or polyethylene, have revolutionised the storage of small parts in workshops and manufacturing facilities.

The containers' signature, practical front openings offer a constant overview of the contents, and enable easy access even when stacked.

Moreover, the broad selection of dimensions and sizes - all designed to be perfectly compatible - allow unrestricted custom combinations. Building the perfect storage system for your needs has never been easier.

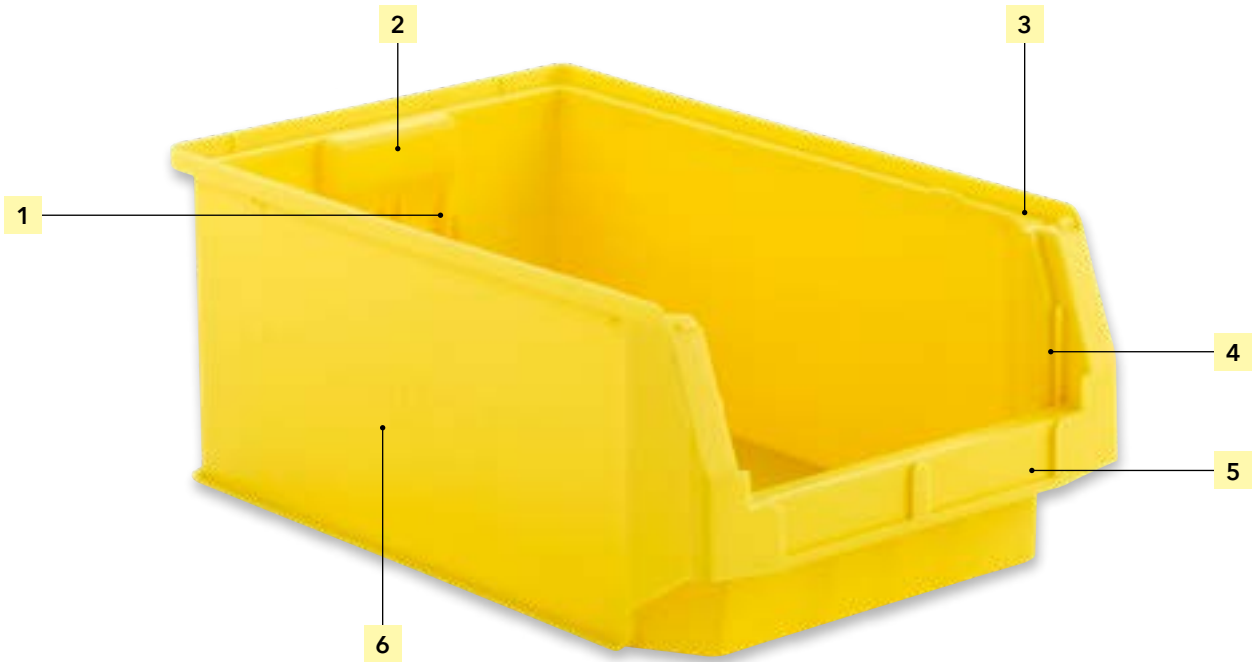

1|

1| Grooves for dividers
for lengthwise partitioning



2|

2| Recessed hand grip
at back



3|

3| Sturdy stacking rim
around full perimeter



4|

4| Grooves
for slide-in panels



5|

5| Label holder
on front



6|

6| Large space for labelling
via injection moulding or hot stamping



Key facts

- The SSI SCHÄFER original
- Revolutionised the storage of small parts in the 1970s
- Still the bestseller among open-fronted storage bins today
- Sturdy
- Long service life

Typical customer applications

- Small parts storage in workshops and production facilities
- Clearly structured organisation in shelving systems

Our expertise: Plastic containers

Storage & transport containers for manual handling

Containers for semi- and fully automated systems

Space-saving containers

Containers for storing small parts

Industry solutions for the automotive industry

Dust cover

transparent plastic; angled to cover front opening



Divider

for lengthwise partitioning



Standard colours:



LF range

92 x 95 x 50 mm



LF 110 PP

External dimensions top/bottom L x W x H	92/70 x 95 x 50 mm			
Colour	Red	Green	Yellow	Blue
Order no.	1142031	1142032	1142033	1142034

LF 110 PPL conductive model

Colour	Black, conductive
Order no.	1142038

LF 110 M PP

External dimensions top/bottom L x W x H	92/70 x 95 x 50 mm			
Colour	Blue			
Order no.	1142044			

LF 110 M PPL conductive model

Colour	Black, conductive
Order no.	1142048

168 x 103 x 52 mm



LF 210 ZW PP with grooves for dividers

External dimensions top/bottom L x W x H	168/139 x 103/97 x 52 mm			
Internal dimensions top/bottom L x W x H	152/136 x 99/88 x 49 mm			
Usable height when stacked	44 mm			
Capacity	0.5 litres			
Load (max.)	1 kg			
Packaging unit	50 units			
Colour	Red	Green	Yellow	Blue
Order no.	6991	6992	6993	6994

168 x 103 x 76 mm



LF 211 ZW PP with grooves for dividers

External dimensions top/bottom L x W x H	168/139 x 103/97 x 76 mm			
Internal dimensions top/bottom L x W x H	150/135 x 99/88 x 74 mm			
Usable height when stacked	67 mm			
Capacity	0.9 litres			
Load (max.)	5 kg			
Packaging unit	50 units			
Colour	Red	Green	Yellow	Blue
Order no.	92191	92192	92193	92194

LF 211 ZW PPL conductive model

Colour	Black, conductive
Order no.	92198

LF 221 CS PP with moulded mounts for panel CS 221

External dimensions top/bottom L x W x H	234/198 x 150/142 x 122 mm			
Internal dimensions top/bottom L x W x H	209/191 x 144/128 x 120 mm			
Usable height when stacked	111 mm			
Capacity	2.7 litres			
Load (max.)	10 kg			
Packaging unit	40 units			
Colour	Red	Green	Yellow	Blue
Order no.	91281	91282	91283	91284

LF 221 CS PPL conductive model

Colour	Black, conductive			
Order no.	91288			

LF 221 ZW CS PP with grooves and moulded mounts for panel CS 221

Colour	Red	Green	Yellow	Blue
Order no.	91291	91292	91293	91294

LF 221 ZW CS PPL conductive model

Colour	Black, conductive			
Order no.	91298			

234 x 150 x 122 mm

**LF 321 G PP** with recessed hand grip

External dimensions top/bottom L x W x H	343/303 x 209/200 x 145 mm			
Internal dimensions top/bottom L x W x H	320/294 x 203/182 x 142 mm			
Usable height when stacked	133 mm			
Capacity	7.5 litres			
Load (max.)	20 kg			
Packaging unit	28 units			
Colour	Red	Green	Yellow	Blue
Order no.	91921	91922	91923	91924

LF 321 G PPL conductive model

Colour	Black, conductive			
Order no.	91928			

LF 321 G ZW PP with recessed hand grip and grooves for dividers

Colour	Red	Green	Yellow	Blue
Order no.	95521	95522	95523	95524

LF 321 G ZW PPL conductive model

Colour	Black, conductive			
Order no.	95528			

343 x 209 x 145 mm

**LF 322 G PP** with recessed hand grip

External dimensions top/bottom L x W x H	343/303 x 209/200 x 200 mm			
Internal dimensions top/bottom L x W x H	320/294 x 203/183 x 197 mm			
Usable height when stacked	185 mm			
Capacity	10.4 litres			
Load (max.)	20 kg			
Packaging unit	20 units			
Colour	Red	Green	Yellow	Blue
Order no.	92011	92012	92013	92014

LF 322 G PPL conductive model

Colour	Black, conductive			
Order no.	92018			

LF 322 G ZW PP with recessed hand grip and grooves for dividers

Colour	Red	Green	Yellow	Blue
Order no.	95511	95512	95513	95514

LF 322 G ZW PPL conductive model

Colour	Black, conductive			
Order no.	95518			

343 x 209 x 200 mm



LF range

350 x 450 x 145 mm



LF 351 ZW PP

External dimensions top/bottom L x W x H	350/300 x 450 x 145 mm			
Internal dimensions L x W x H	291 x 405 x 142 mm			
Usable height when stacked	132 mm			
Capacity	17 litres			
Load (max.)	5 kg			
Packaging unit	10 units			
Colour	Red	Green	Yellow	Blue
Order no.	1142051	1142052	1142053	1142054

380 x 185 x 154 mm



LF 421 G PP with recessed hand grip

External dimensions top/bottom L x W x H	380/336 x 185/176 x 154 mm			
Internal dimensions top/bottom L x W x H	354/331 x 179/158 x 151 mm			
Usable height when stacked	142 mm			
Capacity	7.8 litres			
Load (max.)	20 kg			
Packaging unit	1 unit			
Colour	Red	Green	Yellow	Blue
Order no.	79251	79252	79253	79254

500 x 156 x 143 mm



LF 511 G PP with recessed hand grip

External dimensions top/bottom L x W x H	500/455 x 156/146 x 143 mm			
Internal dimensions top/bottom L x W x H	461/448 x 148/123 x 137 mm			
Usable height when stacked	127 mm			
Capacity	7.6 litres			
Load (max.)	20 kg			
Packaging unit	20 units			
Colour	Red	Green	Yellow	Blue
Order no.	91831*	91832*	91833*	91834

LF 511 G ZW PP with recessed hand grip and grooves for dividers

Colour	Red	Green	Yellow	Blue
Order no.	92111	92112	92113	92114

LF 531 G PP with recessed hand grip

External dimensions top/bottom L x W x H	498/454 x 312/302 x 145 mm			
Internal dimensions top/bottom L x W x H	458/445 x 282/279 x 142 mm			
Usable height when stacked	130 mm			
Capacity	16.5 litres			
Load (max.)	20 kg			
Packaging unit	14 units			
Colour	Red	Green	Yellow	Blue
Order no.	91991	91992	91993	91994

LF 531 G PPL conductive model

Colour	Black, conductive			
Order no.	91998			

LF 531 G ZW PP with recessed hand grip and grooves for dividers

Colour	Red	Green	Yellow	Blue
Order no.	92181	92182	92183	92184

LF 531 G ZW PPL conductive model

Colour	Black, conductive			
Order no.	92188			

500 x 312 x 145 mm

**LF 532 G PP** with recessed hand grip

External dimensions top/bottom L x W x H	498/455 x 312/302 x 200 mm			
Internal dimensions top/bottom L x W x H	458/445 x 282/279 x 197 mm			
Usable height when stacked	185 mm			
Capacity	23.5 litres			
Load (max.)	20 kg			
Packaging unit	10 units			
Colour	Red	Green	Yellow	Blue
Order no.	92001	92002	92003	92004

LF 532 G PPL conductive model

Colour	Black, conductive			
Order no.	92008			

LF 532 G ZW PP with recessed hand grip and grooves for dividers

Colour	Red	Green	Yellow	Blue
Order no.	95501	95502	95503	95504

LF 532 G ZW PPL conductive model

Colour	Black, conductive			
Order no.	95508			

500 x 312 x 200 mm

**LF 533 G PP** with recessed hand grip

External dimensions top/bottom L x W x H	498/454 x 312/302 x 300 mm			
Internal dimensions top/bottom L x W x H	458/444 x 305/277 x 296 mm			
Usable height when stacked	285 mm			
Capacity	38.0 litres			
Load (max.)	20 kg			
Packaging unit	1 unit			
Colour	Red	Green	Yellow	Blue
Order no.	92081*	92082	92083	92084

LF 533 G ZW PP with recessed hand grip and grooves for dividers

Colour	Red	Green	Yellow	Blue
Order no.	92091	92092	92093	92094

500 x 312 x 300 mm



LF range

520 x 470 x 300 mm



LF 543 G PP

External dimensions top/bottom L x W x H	520/450 x 470/450 x 300 mm			
Internal dimensions L x W x H	443 x 425 x 297 mm			
Usable height when stacked	277 mm			
Capacity	57 litres			
Load (max.)	20 kg			
Packaging unit	1 unit			
Colour	Red	Green	Yellow	Blue
Order no.	1142174	1142173	1142172	1142171

LF 543 ZW PP

External dimensions top/bottom L x W x H	520/450 x 470/450 x 300 mm			
Internal dimensions L x W x H	443 x 425 x 297 mm			
Usable height when stacked	277 mm			
Capacity	57 litres			
Load (max.)	20 kg			
Packaging unit	1 unit			
Colour	Red	Green	Yellow	Blue
Order no.	1142164	1142163	1142162	1142161

720 x 470 x 300 mm



LF 743 PP

External dimensions top/bottom L x W x H	720/635 x 470/460 x 300 mm			
Internal dimensions top/bottom L x W x H	675/615 x 435/425 x 295 mm			
Usable height when stacked	278 mm			
Capacity	74.0 litres			
Load (max.)	40 kg			
Packaging unit	1 unit			
Colour	Red	Green	Yellow	Blue
Order no.	1142061	1142062	1142063	1142064

Industry solutions
for the automotive industry

Containers for storing small parts

Space-saving containers

Containers for semi- and
fully automated systems

Storage & transport containers
for manual handling

Our expertise: Plastic containers

Accessories

Dust covers



DC 211



DC 221



DC 321



DC 322



DL 322

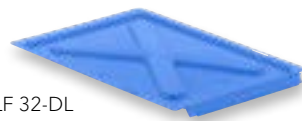

LF 32-DL



DC 511



DC 531



DC 532



DL 532

DC 211 angled front, covered picking side	
for containers	LF 211 ZW
Packaging unit	10 units
Colour	Transparent
Order no.	93240
DC 221 angled front, covered picking side	
for containers	LF 221 ZW
Packaging unit	10 units
Colour	Transparent
Order no.	93230

DC 321 angled front, covered picking side	
for containers	LF 321 G / G ZW
Packaging unit	10 units
Colour	Transparent
Order no.	93140
DC 322 angled front, covered picking side	
for containers	LF 322 G / G ZW
Packaging unit	10 units
Colour	Transparent
Order no.	93130
DL 322 open picking side	
for containers	LF 322
Packaging unit	10 units
Colour	Transparent
Order no.	93200
LF 32-DL open picking side	
for containers	LF 321, LF 322
Packaging unit	10 units
Colour	Blue
Order no.	55385

DC 511 angled front, covered picking side	
for containers	LF 511 G / G ZW
Packaging unit	10 units
Colour	Transparent
Order no.	93290
DC 531 angled front, covered picking side	
for containers	LF 531 G / G ZW
Packaging unit	10 units
Colour	Transparent
Order no.	93220
DC 532 angled front, covered picking side	
for containers	LF 532 / G / ZW / G ZW
Packaging unit	10 units
Colour	Transparent
Order no.	93120
DL 532 open picking side	
for containers	LF 532
Packaging unit	10 units
Colour	Transparent
Order no.	93190

CS 321-L with retaining mechanism

for containers	LF 321 / G ZW
Packaging unit	10 units
Colour	Transparent
Order no.	93110

CS 322-L with retaining mechanism

for containers	LF 322 G / G ZW
Packaging unit	10 units
Colour	Transparent
Order no.	93030

CS 531-L with retaining mechanism

for containers	LF 531 G / G ZW
Packaging unit	10 units
Colour	Transparent
Order no.	91520

CS 532-L with retaining mechanism

for containers	LF 532 G / G ZW
Packaging unit	10 units
Colour	Transparent
Order no.	93020

CS 533-L with retaining mechanism

for containers	LF 533 G / G ZW
Packaging unit	10 units
Colour	Transparent
Order no.	93090

Slide-in panels



CS 321-L



CS 322-L



CS 531-L



CS 532-L



CS 533-L

CS 221-K ready to slot in

for containers	LF 221 CS
Packaging unit	10 units
Colour	Transparent
Order no.	91220

CS 321-K with 2 retaining hooks

for containers	LF 321 / G ZW
Packaging unit	10 units
Colour	Transparent
Order no.	91480

CS 322-K with 2 retaining hooks

for containers	LF 322 G / G ZW
Packaging unit	10 units
Colour	Transparent
Order no.	91490

CS 531-K with 2 retaining hooks

for containers	LF 531 G / G ZW
Packaging unit	10 units
Colour	Transparent
Order no.	91530

CS 532-K with 2 retaining hooks

for containers	LF 532 G / G ZW
Packaging unit	10 units
Colour	Transparent
Order no.	91500

CS 533-K with 2 retaining hooks

for containers	LF 533 G / G ZW
Packaging unit	10 units
Colour	Transparent
Order no.	91510

Sliding flap panels



CS 221-K



CS 321-K



CS 322-K



CS 531-K



CS 532-K



CS 533-K



Retaining hooks

CSH 1

Colour	natural
Order no.	50110

Panel holder POM

Our expertise: Plastic containers

Storage & transport containers for manual handling

Containers for semi- and fully automated systems

Space-saving containers

Containers for storing small parts

Industry solutions for the automotive industry

Accessories

Dividers



ZW-K 210



ZW 211



ZW 221



ZW 321 G



ZW 322 G



RKT 300



ZW 531 G



ZW 532 G



ZW 533 G / ZW 543 G

ZW-K 210 PS for four-way partitioning

for containers	LF 210 ZW
Packaging unit	10 units
Colour	White
Order no.	91900

ZW 211 PS

for containers	LF 211 ZW
Packaging unit	10 units
Colour	White
Order no.	92990

ZW 221 PS

for containers	LF 221 ZW
Packaging unit	10 units
Colour	White
Order no.	91910

ZW 321 G PS

for containers	LF 321 G ZW
Packaging unit	10 units
Colour	White
Order no.	95550

ZW 322 G PS

for containers	LF 322 G ZW
Packaging unit	10 units
Colour	White
Order no.	95540

ZW 351 divider

Colour	White
Order no.	1142030

RKT 300 PS crosswise partitioning

for containers	LF 511 G / G ZW
Packaging unit	10 units
Colour	Transparent
Order no.	14720

ZW 531 G PS

for containers	LF 531 G ZW
Packaging unit	10 units
Colour	White
Order no.	93280

ZW 532 G PS

for containers	LF 532 G ZW
Packaging unit	10 units
Colour	White
Order no.	95530

ZW 533 G / 543 G PS

for containers	LF 533 G ZW
Packaging unit	10 units
Colour	White
Order no.	93080

TS 322

for containers LF 322 / G / ZW / G ZW

Packaging unit 10 units

Colour **Black**

Order no. **93010**

TS 531

for containers LF 531 G / G ZW

Packaging unit 10 units

Colour **Black**

Order no. **93250**

Bars for lifting



Our expertise: Plastic containers

Storage & transport containers for manual handling

Containers for semi- and fully automated systems

Space-saving containers

Containers for storing small parts

Industry solutions for the automotive industry

Accessories

Insert boxes



EK 111 PS

External dimensions L x W x H 137 x 87 x 110 mm

Packaging unit 48 units

Colour Blue

Order no. 22644

EK 111 PPL conductive model

Colour Black, conductive

Order no. 22648



EK 112 PS

External dimensions L x W x H 174 x 137 x 110 mm

Packaging unit 40 units

Colour Blue

Order no. 22634

EK 112 PPL conductive model

Colour Black, conductive

Order no. 22638



EK 113 PS

External dimensions L x W x H 274 x 174 x 110 mm

Packaging unit 36 units

Colour Blue

Order no. 22624

EK 113 PPL conductive model

Colour Black, conductive

Order no. 22628

Suggested partitioning for LF 321 and LF 322



4x EK 111



2x EK 111 and 1x EK 112



2x EK 112

for LF 531, LF 532 and LF 533



9x EK 111



7x EK 111 and 1x EK 112



5x EK 111 and 2x EK 112



3x EK 111 and 3x EK 112



3x EK 111, 1x EK 112 and 1x EK 113

Our expertise: Plastic containers

Storage & transport containers for manual handling

Containers for semi- and fully automated systems

Space-saving containers

Containers for storing small parts

Industry solutions for the automotive industry

Shelf containers - overview and maximum storage density

The plastic shelf containers are also ideal for storing small parts, as they utilise the shelf depth of shelving racks. They can be partitioned into several compartments using

dividers and can be locked in place on the shelf thanks to their specially designed rear lip (drawer principle).

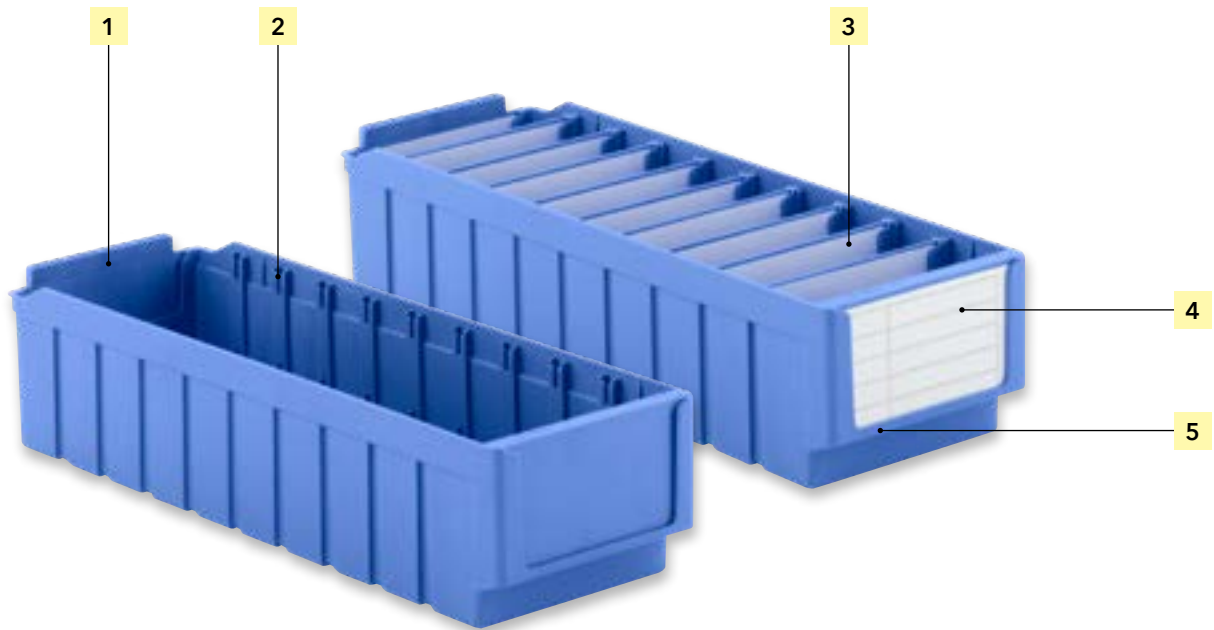

- 1| **Rear lip**
catches on edge
of shelf above
- 2| **Grooves**
for dividers
- 3| **Divider**
with space for labelling
- 4| **Large label holder**
at front
- 5| **Pull grip**
at front



Standard colour:

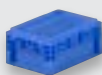



Key facts

- A must-have for clearly structured organisation in shelving systems
- Maximum partitioning options
- Maximum storage volume for small parts
- Compact, secure and proven
- Long service life

Typical customer applications

- Small parts storage on shelves, in drawers, etc.



For shelf depth 300 mm

290 x 162 x 115 mm

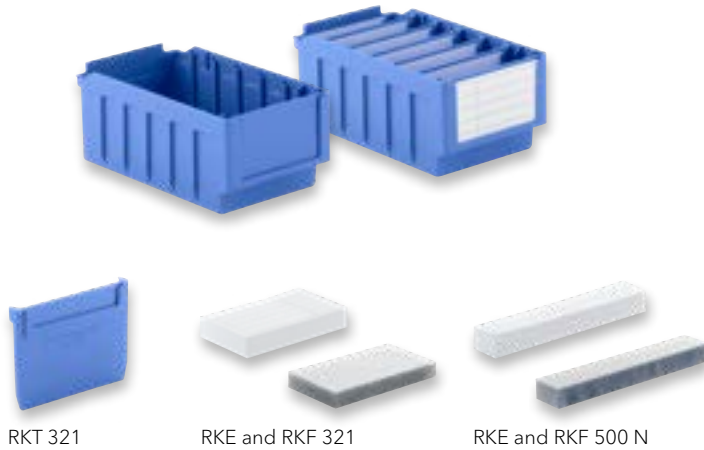

RK 321 PS max. 6 compartments, 6 containers per shelf

External dimensions L x W x H 290 x 162 x 115 mm

Packaging unit 22 units

Colour **Blue**

Order no. **1674**

RKE 321 labels for front side

Packaging unit 100 units

Order no. **1720**

RKF 321 clear protective sheets for front side

Packaging unit 100 units

Order no. **1790**

RKT 321 PS dividers

Packaging unit 25 units

Colour **Blue**

Order no. **1684**

RKE 500 N labels for dividers

Packaging unit 100 units

Order no. **1740**

RKF 500 N clear protective sheets for dividers

Packaging unit 100 units

Order no. **1800**

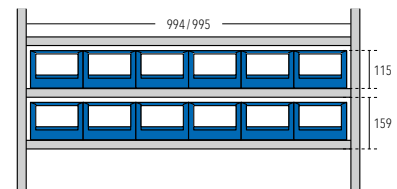

300 x 135 x 120 mm

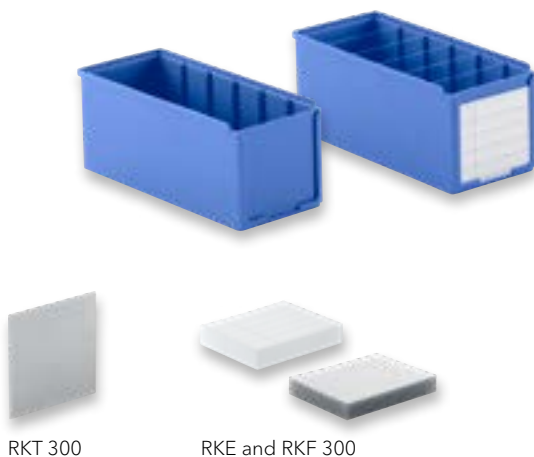

RK 300 PP max. 6 compartments, 7 containers per shelf

External dimensions L x W x H 300 x 135 x 120 mm

Packaging unit 25 units

Colour **Blue**

Order no. **14714**

RKE 300 labels

Packaging unit 100 units

Order no. **21700**

RKF 300 clear protective sheets

Packaging unit 100 units

Order no. **21710**

RKT 300 PP dividers

Packaging unit 25 units

Colour **Transparent**

Order no. **14720**

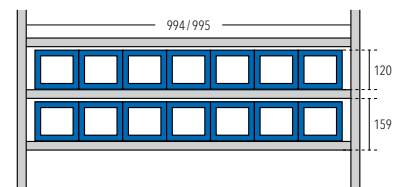

RK 300 HO PP max. 6 compartments, 7 containers per shelf with semi-open front side

External dimensions L x W x H	300 x 135 x 120 mm
Packaging unit	25 units
Colour	Blue
Order no.	14874
RKE 300 HO labels	
Packaging unit	100 units
Order no.	21720
RKF 300 HO clear clear protective sheets	
Packaging unit	100 units
Order no.	21730
RKT 300 PP dividers	
Packaging unit	25 units
Colour	Transparent
Order no.	14720

300 x 135 x 120 mm



RKE and RKF 300 HO

RKT 300

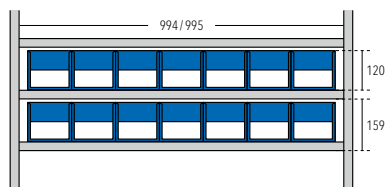

Our expertise: Plastic containers

Storage & transport containers for manual handling

Containers for semi- and fully automated systems

Space-saving containers

Containers for storing small parts

Industry solutions for the automotive industry

For shelf depth 400 mm

390 x 97 x 63 mm

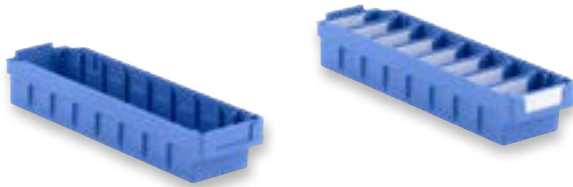

RKT 400 S

RKE and RKF 400 S

RK 400 S PS max. 8 compartments, 10 containers per shelf

External dimensions L x W x H 390 x 97 x 63 mm

Packaging unit 22 units

Colour **Blue**

Order no. **17984**

RKE 400 S labels for front side

Packaging unit 100 units

Order no. **1730**

RKF 400 S clear protective sheets for front side

Packaging unit 100 units

Order no. **1810**

RKT 400 S PS dividers

Packaging unit 25 units

Colour **Blue**

Order no. **17994**

RKE 400 S labels for dividers

Packaging unit 100 units

Order no. **1730**

RKF 400 S clear protective sheets for dividers

Packaging unit 100 units

Order no. **1810**

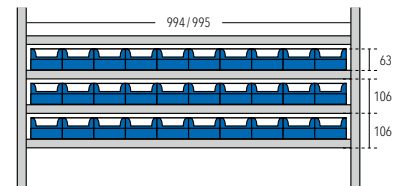

390 x 243 x 115 mm



RKT 5/421 B

RKE and RKF 500 N

RKE and RKF 321

RK 421 B PS max. 8 compartments, 4 containers per shelf

External dimensions L x W x H 390 x 243 x 115 mm

Packaging unit 13 units

Colour **Blue**

Order no. **1564**

RKE 321 labels for front side

Packaging unit 100 units

Order no. **1720**

RKF 321 clear protective sheets for front side

Packaging unit 100 units

Order no. **1790**

RKT 5/421 B PS dividers

Packaging unit 25 units

Colour **Blue**

Order no. **1574**

RKE 500 N labels for dividers

Packaging unit 100 units

Order no. **1740**

RKF 500 N clear protective sheets for dividers

Packaging unit 100 units

Order no. **1800**

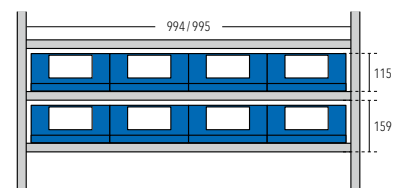

RK 400 PS max. 8 compartments, 6 containers per shelf

External dimensions L x W x H 408 x 162 x 66 mm

Packaging unit 20 units

Colour Blue

Order no. 17904

RKE 500 N labels for front side

Packaging unit 100 units

Order no. 1740

RKF 500 N clear protective sheets for front side

Packaging unit 100 units

Order no. 1800

RKT 400 PS dividers

Packaging unit 25 units

Colour Blue

Order no. 17914

RKE 400 labels for dividers

Packaging unit 100 units

Order no. 17920

RKF 400 clear protective sheets for dividers

Packaging unit 100 units

Order no. 17930

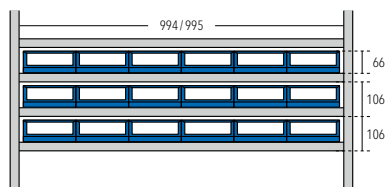

408 x 162 x 66 mm

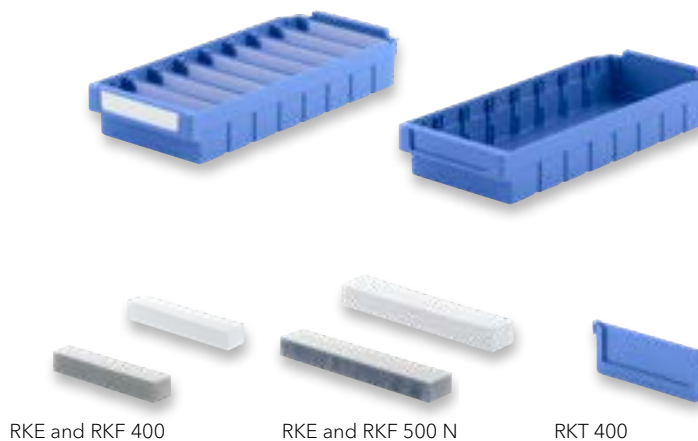

RKE and RKF 400

RKE and RKF 500 N

RKT 400

RK 421 PS max. 8 compartments, 6 containers per shelf

External dimensions L x W x H 408 x 162 x 115 mm

Packaging unit 16 units

Colour Blue

Order no. 16904

RKE 321 labels for front side

Packaging unit 100 units

Order no. 1720

RKF 321 clear protective sheets for front side

Packaging unit 100 units

Order no. 1790

RKT 5/421 PS dividers

Packaging unit 25 units

Colour Blue

Order no. 16924

RKE 400 labels for dividers

Packaging unit 100 units

Order no. 17920

RKF 400 clear protective sheets for dividers

Packaging unit 100 units

Order no. 17930

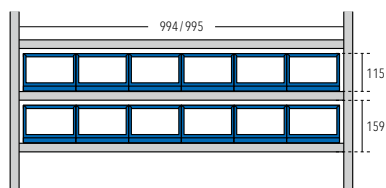

408 x 162 x 115 mm

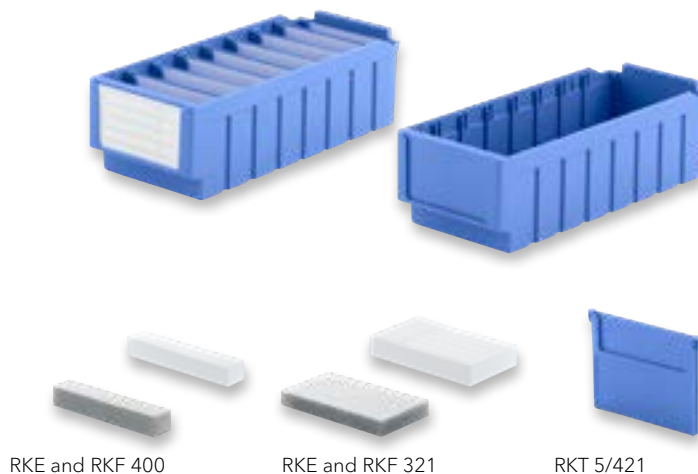

RKE and RKF 400

RKE and RKF 321

RKT 5/421

For shelf depth 500 mm

490 x 162 x 63 mm

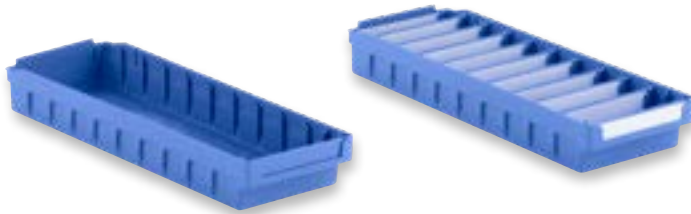

RKT 500 N

RKE and RKF 500 N

RK 500 N PS max. 10 compartments, 6 containers per shelf	
External dimensions L x W x H	490 x 162 x 63 mm
Packaging unit	40 units
Colour	Blue
Order no.	1584
RKE 500 N labels for front side	
Packaging unit	100 units
Order no.	1740
RKF 500 N clear protective sheets for front side	
Packaging unit	100 units
Order no.	1800
RKT 500 N PS dividers	
Packaging unit	25 units
Colour	Blue
Order no.	1594
RKE 500 N labels for dividers	
Packaging unit	100 units
Order no.	1740
RKF 500 N clear protective sheets for dividers	
Packaging unit	100 units
Order no.	1800

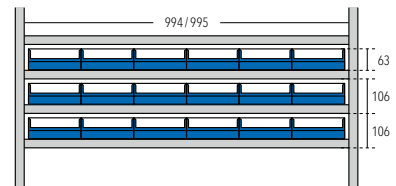

490 x 243 x 115 mm



RKT 5/421 B

RKE and RKF 500 N

RKE and RKF 321

RK 521 B PS max. 10 compartments, 4 containers per shelf	
External dimensions L x W x H	490 x 243 x 115 mm
Packaging unit	10 units
Colour	Blue
Order no.	1554
RKE 321 labels for front side	
Packaging unit	100 units
Order no.	1720
RKF 321 clear protective sheets for front side	
Packaging unit	100 units
Order no.	1790
RKT 5/421 B PS dividers	
Packaging unit	25 units
Colour	Blue
Order no.	1574
RKE 500 N labels for dividers	
Packaging unit	100 units
Order no.	1740
RKF 500 N clear protective sheets for dividers	
Packaging unit	100 units
Order no.	1800

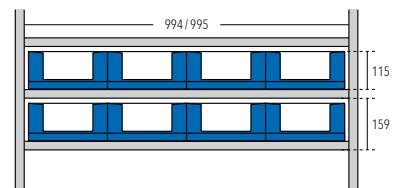

RK 521 PS max. 10 compartments, 6 containers per shelf

External dimensions L x W x H 508 x 162 x 115 mm

Packaging unit 20 units

Colour Blue

Order no. 16914

RKE 321 labels for front side

Packaging unit 100 units

Order no. 1720

RKF 321 clear protective sheets for front side

Packaging unit 100 units

Order no. 1790

RKT 5/421 PS dividers

Packaging unit 25 units

Colour Blue

Order no. 16924

RKE 400 labels for dividers

Packaging unit 100 units

Order no. 17920

RKF 400 clear protective sheets for dividers

Packaging unit 100 units

Order no. 17930

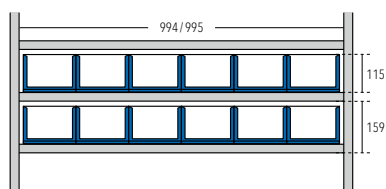

508 x 162 x 115 mm

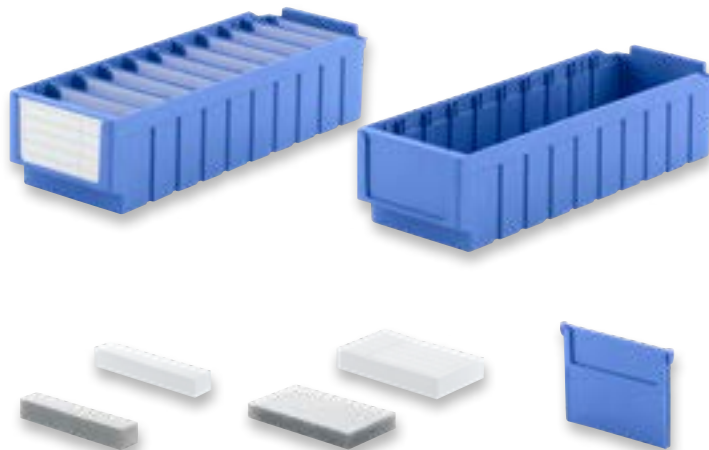

RKE and RKF 400

RKE and RKF 321

RKT 5/421

RK 522 PP max. 4 compartments, 5 containers per shelf

External dimensions L x W x H 520 x 190 x 121 mm

Packaging unit 15

Colour Blue

Order no. 1874

RKE 522 S labels for front side

Packaging unit 100 units

Order no. 4520

RKF 522 S clear protective sheets for front side

Packaging unit 100 units

Order no. 4530

RKT 522 PP dividers

Packaging unit 25 units

Colour Blue

Order no. 1880

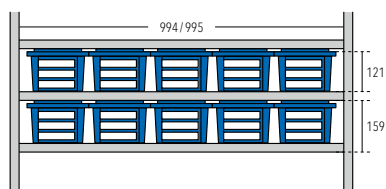

520 x 190 x 121 mm

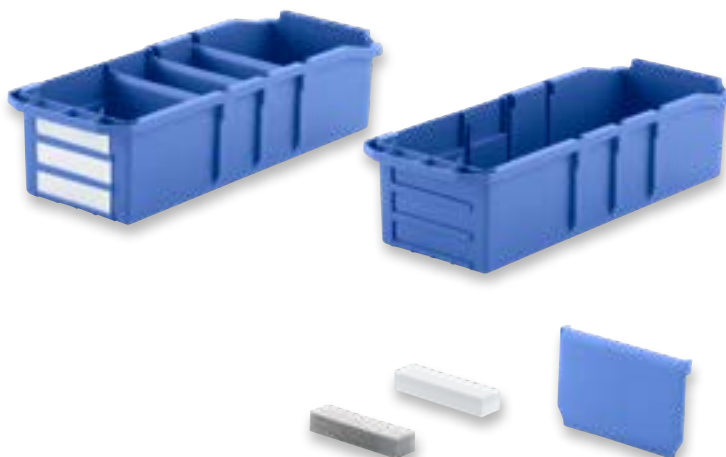

RKE and RKF 522 S

RKT 522

Our expertise: Plastic containers

Storage & transport containers for manual handling

Containers for semi- and fully automated systems

Space-saving containers

Containers for storing small parts

Industry solutions for the automotive industry

For shelf depth 600 mm

590 x 162 x 115 mm

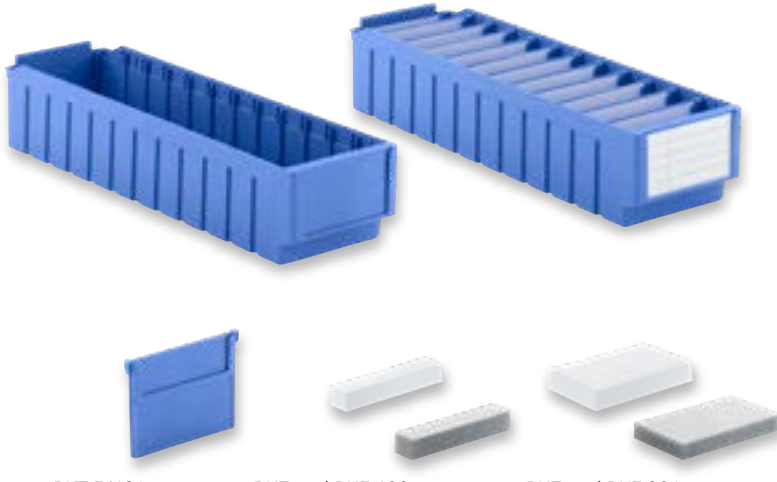

RKT 5/421

RKE and RKF 400

RKE and RKF 321

RK 621 PS max. 12 compartments, 6 containers per shelf

External dimensions L x W x H 590 x 162 x 115 mm

Packaging unit 12 units

Colour **Blue**

Order no. **1894**

RKE 321 labels for front side

Packaging unit 100 units

Order no. **1720**

RKF 321 clear protective sheets for front side

Packaging unit 100 units

Order no. **1790**

RKT 5/421 PS dividers

Packaging unit 25 units

Colour **Blue**

Order no. **16924**

RKE 400 labels for dividers

Packaging unit 100 units

Order no. **17920**

RKF 400 clear protective sheets for dividers

Packaging unit 100 units

Order no. **17930**

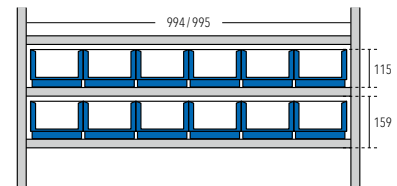

590 x 243 x 115 mm

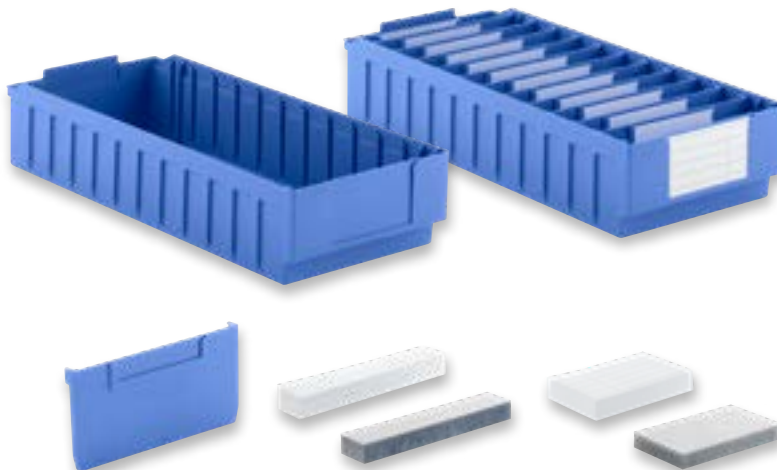

RKT 5/421 B

RKE and RKF 500 N

RKE and RKF 321

RK 621 B PS max. 12 compartments, 4 containers per shelf

External dimensions L x W x H 590 x 243 x 115 mm

Packaging unit 8 units

Colour **Blue**

Order no. **1904**

RKE 321 labels for front side

Packaging unit 100 units

Order no. **1720**

RKF 321 clear protective sheets for front side

Packaging unit 100 units

Order no. **1790**

RKT 5/421 B PS dividers

Packaging unit 25 units

Colour **Blue**

Order no. **1574**

RKE 500 N labels for dividers

Packaging unit 100 units

Order no. **1740**

RKF 500 N clear protective sheets for dividers

Packaging unit 100 units

Order no. **1800**

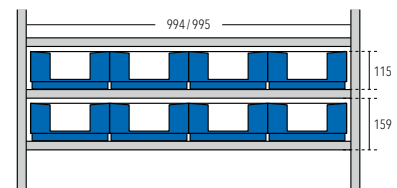

RK 619-02 PP max. 11 compartments, 8 containers per shelf

External dimensions L x W x H 599 x 116 x 90 mm

Packaging unit 20 units

Colour Blue

Order no. 20954

RKE 619 labels for front side

Packaging unit 100 units

Order no. 20910

RKF 619 clear protective sheets for front side

Packaging unit 100 units

Order no. 20920

RKT 61 PP dividers

Packaging unit 25 units

Colour Blue

Order no. 21154

RKE 619 labels for dividers

Packaging unit 100 units

Order no. 20910

RKF 619 clear protective sheets for dividers

Packaging unit 100 units

Order no. 20920

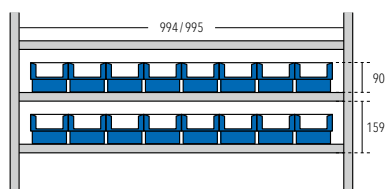

599 x 116 x 90 mm

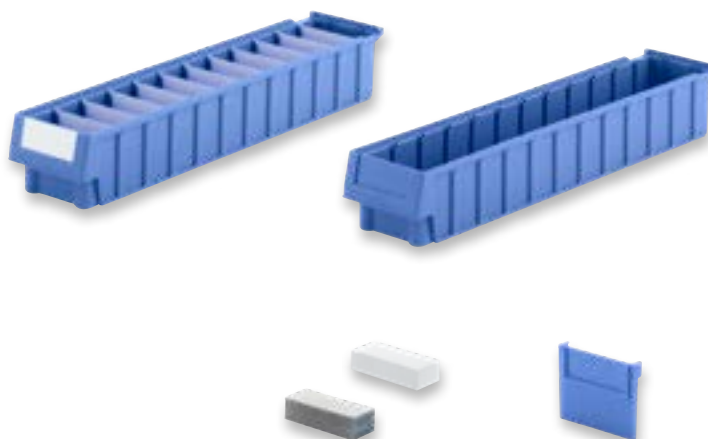

RKE and RKF 619

RKT 61

RK 629-02 PP max. 11 compartments, 4 containers per shelf

External dimensions L x W x H 599 x 232 x 90 mm

Packaging unit 10 units

Colour Blue

Order no. 20964

RKE 629 labels for front side

Packaging unit 100 units

Order no. 20930

RKF 629 clear protective sheets for front side

Packaging unit 100 units

Order no. 20940

RKT 62 PP dividers

Packaging unit 25 units

Colour Blue

Order no. 21174

RKE 629 labels for dividers

Packaging unit 100 units

Order no. 20930

RKF 629 clear protective sheets for dividers

Packaging unit 100 units

Order no. 20940

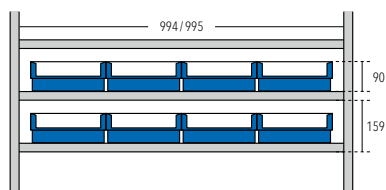

599 x 232 x 90 mm

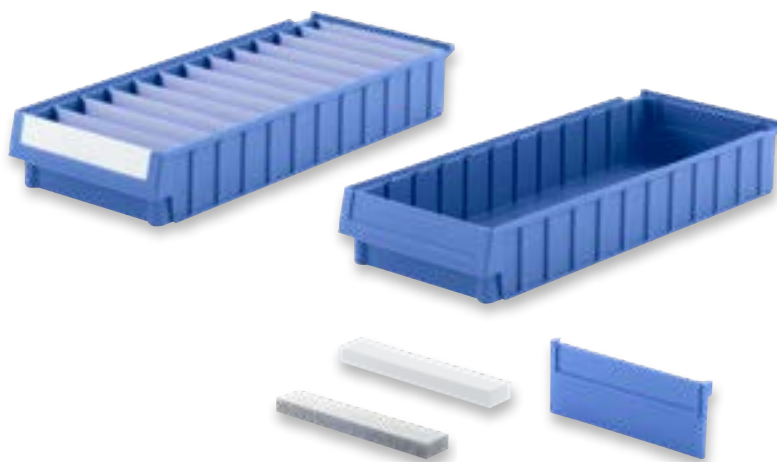

RKE and RKF 629

RKT 62

Our expertise: Plastic containers

Storage & transport containers for manual handling

Containers for semi- and fully automated systems

Space-saving containers

Containers for storing small parts

Industry solutions for the automotive industry

For shelf depth 600 mm

620 x 116 x 90 mm



RKT 61



RKE and RKF 619

RK 619-01 PP max. 12 compartments, 8 containers per shelf

External dimensions L x W x H 620 x 116 x 90 mm

Packaging unit 20 units

Colour **Blue**

Order no. **21144**

RKE 619 labels for front side

Packaging unit 100 units

Order no. **20910**

RKF 619 clear protective sheets for front side

Packaging unit 100 units

Order no. **20920**

RKT 61 PP dividers

Packaging unit 25 units

Colour **Blue**

Order no. **21154**

RKE 619 labels for dividers

Packaging unit 100 units

Order no. **20910**

RKF 619 clear protective sheets for dividers

Packaging unit 100 units

Order no. **20920**

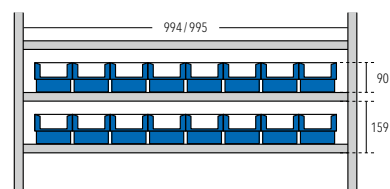

RK 629-01 PP max. 12 compartments, 4 containers per shelf	
External dimensions L x W x H	620 x 232 x 90 mm
Packaging unit	10 units
Colour	Blue
Order no.	21164
RKE 629 labels for front side	
Packaging unit	100 units
Order no.	20930
RKF 629 clear protective sheets for front side	
Packaging unit	100 units
Order no.	20940
RKT 62 PP dividers	
Packaging unit	25 units
Colour	Blue
Order no.	21174
RKE 629 labels for dividers	
Packaging unit	100 units
Order no.	20930
RKF 629 clear protective sheets for dividers	
Packaging unit	100 units
Order no.	20940

620 x 232 x 90 mm



RKT 62

RKE and RKF 629

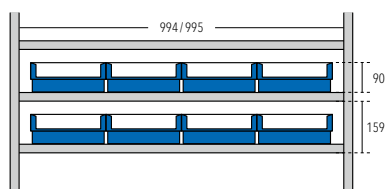

Our expertise: Plastic containers

Storage & transport containers for manual handling

Containers for semi- and fully automated systems

Space-saving containers

Containers for storing small parts

Industry solutions for the automotive industry

Insert boxes for shelving and drawers

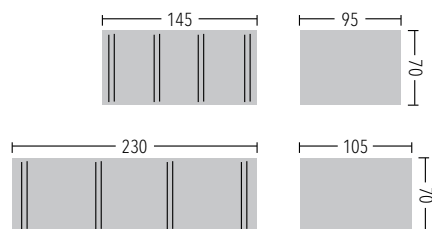

EK14-2 PP

External dimensions L x W x H	145 x 95 x 70 mm	
Colour	Blue	
Order no.	7104	

EK14-3 PP

External dimensions L x W x H	230 x 105 x 70 mm	
Colour	Blue	
Order no.	7174	

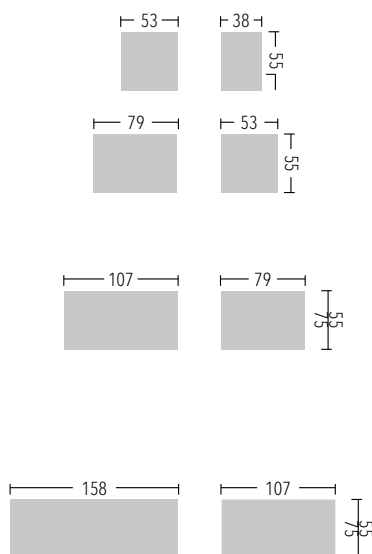

EK 10 PS

External dimensions L x W x H	53 x 38 x 55 mm	
Colour	Blue	Red
Order no.	22764	22761

EK 9 PS

External dimensions L x W x H	79 x 53 x 55 mm	
Colour	Blue	Red
Order no.	22754	22751

EK 8 PS

External dimensions L x W x H	107 x 79 x 55 mm	
Colour	Blue	Red
Order no.	22744	22741

EK 12 PS

External dimensions L x W x H	107 x 79 x 75 mm	
Colour	Blue	Red
Order no.	22784	22781

EK 7 PS

External dimensions L x W x H	158 x 107 x 55 mm	
Colour	Blue	Red
Order no.	22734	22731

EK 11 PS

External dimensions L x W x H	158 x 107 x 75 mm	
Colour	Blue	Red
Order no.	22774	22771

EK 301 PS		
External dimensions L x W x H	58 x 29 x 30 mm	
Colour	Red	
Order no.	4541	
EK 302 PS		
External dimensions L x W x H	58 x 58 x 30 mm	
Colour	Red	
Order no.	4551	
EK 303 PS		
External dimensions L x W x H	116 x 58 x 30 mm	
Colour	Red	
Order no.	4561	
EK 304 PS		
External dimensions L x W x H	116 x 116 x 30 mm	
Colour	Red	
Order no.	4571	
EK 351 PS		
External dimensions L x W x H	53 x 40 x 35 mm	
Colour	Blue	
Order no.	22574	
EK 352 PS		
External dimensions L x W x H	79 x 53 x 35 mm	
Colour	Blue	Red
Order no.	22584	22581
EK 353 PS		
External dimensions L x W x H	105 x 79 x 35 mm	
Colour	Blue	Red
Order no.	22594	22591
EK 401 PS		
External dimensions L x W x H	54 x 54 x 40 mm	
Colour	Blue	
Order no.	4654	
EK 402 PS		
External dimensions L x W x H	54 x 108 x 40 mm	
Colour	Blue	
Order no.	4664	
EK 403 PS		
External dimensions L x W x H	108 x 108 x 40 mm	
Colour	Blue	
Order no.	4674	
EK 501 PS		
External dimensions L x W x H	72 x 52 x 50 mm	
Colour	Blue	Red
Order no.	4904	4901
EK 502 PS		
External dimensions L x W x H	72 x 104 x 50 mm	
Colour	Blue	Red
Order no.	4914	4911
EK 503 PS		
External dimensions L x W x H	144 x 104 x 50 mm	
Colour	Blue	Red
Order no.	4924	4921
EK 504 PS		
External dimensions L x W x H	144 x 208 x 50 mm	
Colour	Blue	Red
Order no.	4934	4931

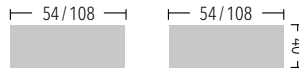
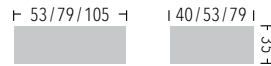

Our expertise: Plastic containers

Storage & transport containers for manual handling

Containers for semi- and fully automated systems

Space-saving containers

Containers for storing small parts

Industry solutions for the automotive industry

14/6 - structured organisation in the warehouse and in transit

The stacking transport containers in the 14/6 range are versatile, robust, stackable and yet easy to handle. The containers also integrate perfectly into manual logistics and production processes, where they make a decisive contribution to efficiency in material flows.

The modular 14/6 containers are designed with fully closed sides and strong stacking rims - making them sufficiently robust for day-to-day warehouse operations. Recessed hand grips enable easy carrying. A conductive ESD-safe model is also available where required.



- 1| **Recessed hand grip**
on short sides
- 2| **Strong rim**
for secure stacking
- 3| **Label holder**
on short side
- 4| **Highly robust lip**
at container base





Key facts

- Versatile customer favourite for generations
- Clearly structured organisation in the shelving
- Easy to handle thanks to recessed hand grips
- Convenient to carry, stack and transport
- Sturdy
- Long service life

Typical customer applications

- Small parts storage in shelving and/or
as a replenishment container in a flow rack

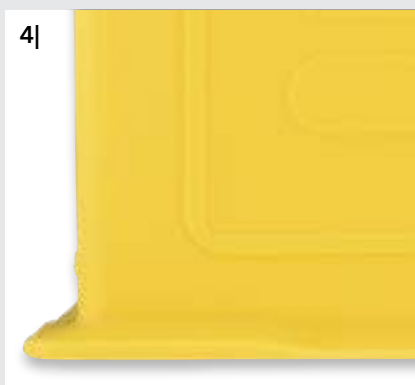

Standard colours:

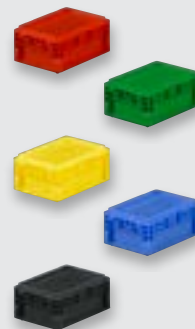

Special 14/6 range

210 x 150 x 123 mm



14/6-4 PP

External dimensions top/bottom L x W x H	210/200 x 150/140 x 123 mm			
Internal dimensions L x W x H	190 x 123 x 119 mm			
Usable height when stacked	110 mm			
Capacity	2.5 litres			
Load (max.)	10 kg			
Packaging unit	40 units			
Colour	Red	Green	Yellow	Blue
Order no.	8151	8152	8153	8154

14/6-4 PPL conductive model

Colour	Black, conductive			
Order no.	8158			

310 x 210 x 145 mm



14/6-3 PP

External dimensions top/bottom L x W x H	310/303 x 210/200 x 145 mm			
Internal dimensions L x W x H	285 x 183 x 142 mm			
Usable height when stacked	133 mm			
Capacity	7.0 litres			
Load (max.)	20 kg			
Packaging unit	20 units			
Colour	Red	Green	Yellow	Blue
Order no.	8121	8122	8123	8124

14/6-3 PPL conductive model

Colour	Black, conductive			
Order no.	8128			

310 x 210 x 197 mm



14/6-3 S PP with card holder on the front side

External dimensions top/bottom L x W x H	311/302 x 210/201 x 197 mm			
Internal dimensions L x W x H	286 x 182 x 194 mm			
Usable height when stacked	182 mm			
Capacity	9.3 litres			
Load (max.)	20 kg			
Packaging unit	1 unit			
Colour	Red	Green	Yellow	Blue
Order no.	14131	14132	14133	14134

14/6-3 S PPL conductive model

Colour	Black, conductive			
Order no.	14138*			

14/6-2 F PP

External dimensions top/bottom L x W x H	465/450 x 314/300 x 72 mm			
Internal dimensions L x W x H	430 x 279 x 69 mm			
Usable height when stacked	59 mm			
Capacity	8.0 litres			
Load (max.)	20 kg			
Packaging unit	30 units			
Colour	Red	Green	Yellow	Blue
Order no.	15491	15492	15493	15494

14/6-2 F PPL conductive model

Colour	Black, conductive			
Order no.	15498			

465 x 314 x 72 mm

**14/6-2 G PP**

External dimensions top/bottom L x W x H	465/450 x 314/300 x 105 mm			
Internal dimensions L x W x H	429 x 279 x 101 mm			
Usable height when stacked	89 mm			
Capacity	10.3 litres			
Load (max.)	20 kg			
Packaging unit	20 units			
Colour	Red	Green	Yellow	Blue
Order no.	14121	14122	14123	14124

14/6-2 G PPL conductive model

Colour	Black, conductive			
Order no.	14128			

465 x 314 x 105 mm

**14/6-2 H PP** with label holders

External dimensions top/bottom L x W x H	465/450 x 314/300 x 120 mm			
Internal dimensions L x W x H	428 x 278 x 116 mm			
Usable height when stacked	104 mm			
Capacity	12.0 litres			
Load (max.)	20 kg			
Packaging unit	16 units			
Colour	Red	Green	Yellow	Blue
Order no.	14361	14362	14363	14364

14/6-2 H PPL conductive model

Colour	Black, conductive			
Order no.	14368			

465 x 314 x 120 mm



Special 14/6 range

465 x 314 x 198 mm



14/6-2 PP with label holders

External dimensions top/bottom L x W x H	465/450 x 314/300 x 198 mm			
Internal dimensions L x W x H	426 x 278 x 194 mm			
Usable height when stacked	182 mm			
Capacity	21.0 litres			
Load (max.)	30 kg			
Packaging unit	10 units			
Colour	Red	Green	Yellow	Blue
Order no.	8091	8092	8093	8094

14/6-2 PPL conductive model

Colour	Black, conductive			
Order no.	8098			

485 x 314 x 233 mm



14/6-230 PP underbarrel handle on request

External dimensions top/bottom L x W x H	485/453 x 314/303 x 233 mm			
Internal dimensions L x W x H	425 x 275 x 230 mm			
Usable height when stacked	218 mm			
Capacity	26.0 litres			
Load (max.)	30 kg			
Packaging unit	10 units			
Colour	Red	Green	Yellow	Blue
Order no.	15751	15752	15753	15754

14/6-230 PPL conductive model

Colour	Black, conductive			
Order no.	15758			

465 x 314 x 298 mm



14/6-2 Z PP with label holders

External dimensions top/bottom L x W x H	465/454 x 314/303 x 298 mm			
Internal dimensions L x W x H	423 x 272 x 294 mm			
Usable height when stacked	282 mm			
Capacity	33.0 litres			
Load (max.)	30 kg			
Packaging unit	1 unit			
Colour	Red	Green	Yellow	Blue
Order no.	14371	14372	14373	14374

Special 14/6 range and accessories

14/6-1 PP with label holders

External dimensions top/bottom L x W x H	650/641 x 468/460 x 300 mm			
Internal dimensions L x W x H	608 x 426 x 296 mm			
Usable height when stacked	278 mm			
Capacity	71.0 litres			
Load (max.)	40 kg			
Packaging unit	4 units			
Colour	Red	Green	Yellow	Blue
Order no.	95301	95302	95303	95304

14/6-1 PPL conductive model

Colour	Black, conductive			
Order no.	95308*			

650 x 468 x 300 mm



SD-14/6-4 PS with finger hole

for containers	14/6-4
Packaging unit	10 units
Colour	White
Order no.	13666

Dust covers



SD-14/6-3 PS with finger hole

for containers	14/6-3
Packaging unit	10 units
Colour	White
Order no.	13656



SD-14/6-2 PS with finger hole

for containers	14/6-2
Packaging unit	10 units
Colour	White
Order no.	15946



SD-14/6-1 PS with finger hole

for containers	14/6-1
Packaging unit	10 units
Colour	White
Order no.	16006



Accessories

Insert boxes



EK 3 PS

External dimensions L x W x H	90 x 48 x 60 mm	
for containers	14/6-3	
Required quantity	12 units	
Packaging unit	120 units	
Colour	Blue	Red
Order no.	1154	1151

EK 3 PPL conductive model

Colour	Black, conductive	
Order no.	1158	

EK 2 PS

External dimensions L x W x H	96 x 90 x 60 mm	
for containers	14/6-3	
Required quantity	6 units	
Packaging unit	80 units	
Colour	Blue	Red
Order no.	1144	1141

EK 2 PPL conductive model

Colour	Black, conductive	
Order no.	1148	

EK 1 PS

External dimensions L x W x H	180 x 96 x 60 mm	
for containers	14/6-3	
Required quantity	3 units	
Packaging unit	58 units	
Colour	Blue	Red
Order no.	1134	1131

EK 1 PPL conductive model

Colour	Black, conductive	
Order no.	1138	

EK 111-N PS

External dimensions L x W x H	137 x 87 x 96 mm	
for containers	14/6-2 H	
Required quantity	9 units	
Packaging unit	48 units	
Colour	Blue	
Order no.	4364	

EK 111-N PPL conductive model

Colour	Black, conductive	
Order no.	4368	

EK 111 PS

External dimensions L x W x H	137 x 87 x 110 mm	
for containers	14/6-2	
Required quantity	9 units	
Packaging unit	48 units	
Colour	Blue	
Order no.	22644	

EK 111 PPL conductive model

Colour	Black, conductive	
Order no.	22648	

Suggested partitioning

For 14/6-3



12x EK 3



6x EK 2

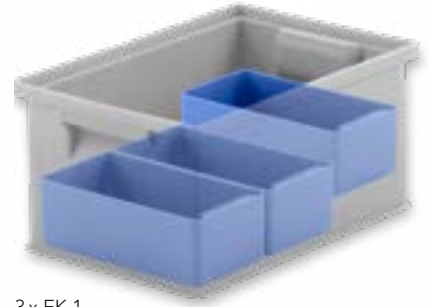

3x EK 1

For 14/6-2 H



9x EK 111-N

For 14/6-2

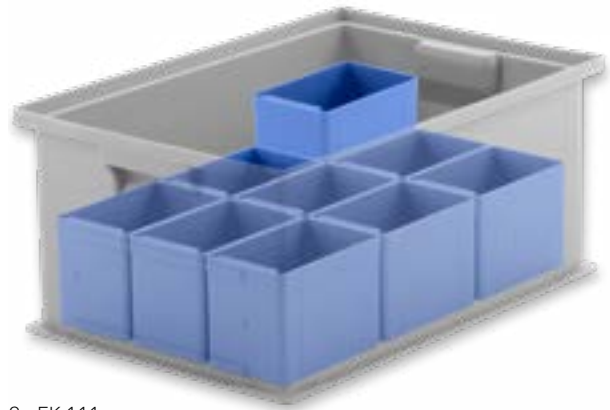

9x EK 111



Industry solutions for the automotive industry

- R-KLT range from page F2
- R-KLT ESD range from page F8
- RL-KLT range from page F14
- RL-KLT ESD range from page F22
- C-KLT range from page F28
- Special L-KLT range from page F36

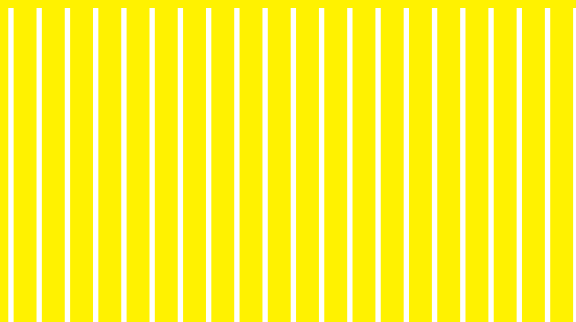

R-KLT, manufactured to the VDA 4500 standard

The Re-Design KLT is the new KLT generation - designed to meet increasingly demanding supply chain requirements. The robust R-KLT reflects the general industry trend toward reducing loads to a maximum of 20 kg. It is lighter than its predecessor, and provides even greater storage capacity.

The containers' composite bases prevent tipping and allow them to be securely stacked. Moreover, their single-walled design delivers increased stability, thanks to additional reinforcing struts.



- 1| Lifting slots**
for vertical retrieval
- 2| Ergonomic underbarrel handle**
on short side
- 3| Sturdy stacking corners**
for high stability
- 4| Label holders**
on one short side and one side wall
- 5| Additional grip**
on side wall



Standard colour:





Robust composite base
(max. load 20 kg)

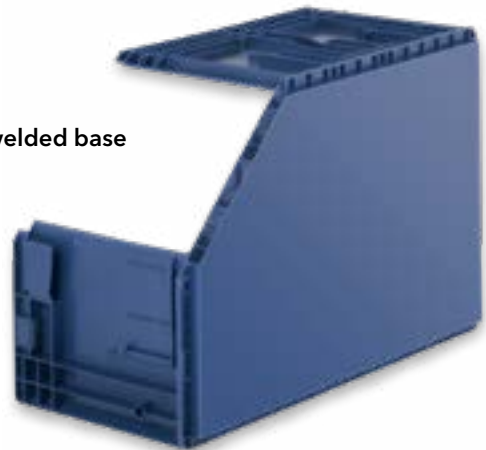

VS01 vibration-welded base
(max. load 50 kg)

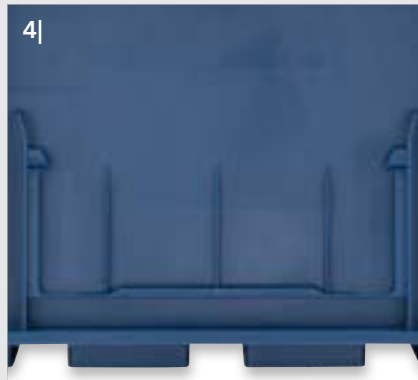

Our expertise: Plastic containers

Storage & transport containers for manual handling

Containers for semi- and fully automated systems

Space-saving containers

Containers for storing small parts

Industry solutions for the automotive industry

R-KLT, manufactured to the VDA 4500 standard

300 x 200 x 148 mm



R-KLT 3215 PP

External dimensions L x W x H	297 x 198 x 147.5 mm
Internal dimensions L x W x H	243 x 162 x 144.8 mm
Usable height when stacked	129.5 mm
Capacity when stacked	5.3 litres
Load (max.)	20 kg
Live load (max.)	400 kg
Colour	RAL 5003
Order no.	20704

400 x 300 x 148 mm



R-KLT 4315 PP

External dimensions L x W x H	396 x 297 x 147.5 mm
Internal dimensions L x W x H	346 x 265 x 124.5 mm
Usable height when stacked	109.5 mm
Capacity when stacked	10.1 litres
Load (max.)	20 kg
Live load (max.)	600 kg
Colour	RAL 5003
Order no.	20714

R-KLT 4329 PP

External dimensions L x W x H	396 x 297 x 280 mm
Internal dimensions L x W x H	346 x 265 x 257.3 mm
Usable height when stacked	242.3 mm
Capacity when stacked	22.3 litres
Load (max.)	20 kg
Live load (max.)	600 kg
Colour	RAL 5003
Order no.	20724

400 x 300 x 280 mm

**R-KLT 6415 PP**

External dimensions L x W x H	594 x 396 x 147.5 mm
Internal dimensions L x W x H	544 x 364 x 124.5 mm
Usable height when stacked	109.5 mm
Capacity when stacked	21.8 litres
Load (max.)	20 kg
Live load (max.)	600 kg
Colour	RAL 5003
Order no.	20794

600 x 400 x 148 mm



R-KLT, manufactured to the VDA 4500 standard

600 x 400 x 174 mm



R-KLT 6418 PP**

External dimensions L x W x H	594 x 396 x 174 mm
Internal dimensions L x W x H	544 x 364 x 151 mm
Usable height when stacked	136 mm
Capacity when stacked	27.0 litres
Load (max.)	20 kg
Live load (max.)	600 kg
Colour	RAL 5003
Order no.	79444*

R-KLT 6418 VS01 PP** with vibration-welded base

Internal dimensions L x W x H	544 x 364 x 151 mm
Usable height when stacked	136 mm
Capacity when stacked	27.0 litres
Load (max.)	50 kg
Colour	RAL 5003
Order no.	79454*

** without recommendation from German Association of the Automotive Industry (VDA)

600 x 400 x 214 mm



R-KLT 6422 PP

External dimensions L x W x H	594 x 396 x 213.75 mm
Internal dimensions L x W x H	544 x 364 x 190.8 mm
Usable height when stacked	175.8 mm
Capacity when stacked	34.9 litres
Load (max.)	20 kg
Live load (max.)	600 kg
Colour	RAL 5003
Order no.	79414*

R-KLT 6422 VS01 PP** with vibration-welded base

Internal dimensions L x W x H	544 x 364 x 190.8 mm
Usable height when stacked	175.8 mm
Capacity when stacked	34.9 litres
Load (max.)	50 kg
Colour	RAL 5003
Order no.	79424*

** without recommendation from German Association of the Automotive Industry (VDA)

600 x 400 x 280 mm



R-KLT 6429 PP

External dimensions L x W x H	594 x 396 x 280 mm
Internal dimensions L x W x H	544 x 364 x 257 mm
Usable height when stacked	242 mm
Capacity when stacked	48.1 litres
Load (max.)	20 kg
Live load (max.)	600 kg
Colour	RAL 5003
Order no.	20734

R-KLT 6429 VS01 PP** with vibration-welded base

Internal dimensions L x W x H	544 x 364 x 257 mm
Usable height when stacked	242 mm
Capacity when stacked	48.1 litres
Load (max.)	50 kg
Colour	RAL 5003
Order no.	24584*

** without recommendation from German Association of the Automotive Industry (VDA)

Accessories

RL-KLT-D 35 PP drop-on lid 300 x 200 mm

Colour RAL 5005

Order no. 20854

RL-KLT-D 45 PP drop-on lid 400 x 300 mm

Colour RAL 5005

Order no. 20834

RL-KLT-D 65 PP drop-on lid 600 x 400 mm

Colour RAL 5005

Order no. 20844

Lids

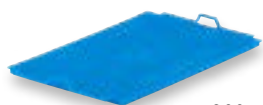

300 x 200 mm

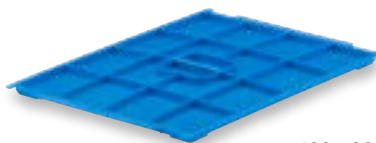

400 x 300 mm

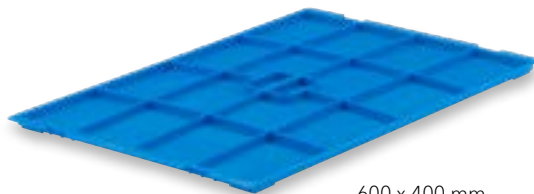

600 x 400 mm

A 1208 PP** pallet cover 1200 x 800 mm

Colour RAL 5012

Order no. 39704

A 1208-1 PP pallet cover 1200 x 800 mm

Colour RAL 5012

Order no. 35614

** without recommendation from German Association of the Automotive Industry (VDA)

Additional colours and sizes available on request

Pallet covers



A 1208 PP

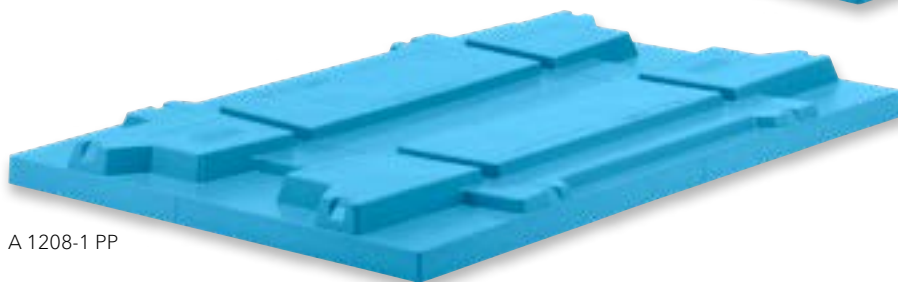

A 1208-1 PP

R-KLT, manufactured to VDA 4504 - for electrostatic discharge

R-KLT and R-KLT ESD containers are identical - the material is the only exception. The ESD-safe version is made from plastic with exceptional conductive properties. It is the container of choice for safely and securely transporting electronic components between suppliers and automakers.

The range comprises ESD-safe versions of both the R-KLT container and the KLT lid, manufactured to the VDA standards. Both are compatible with ISO (1,200 x 1,000 mm) and Euro (1,200 x 800 mm) pallets.

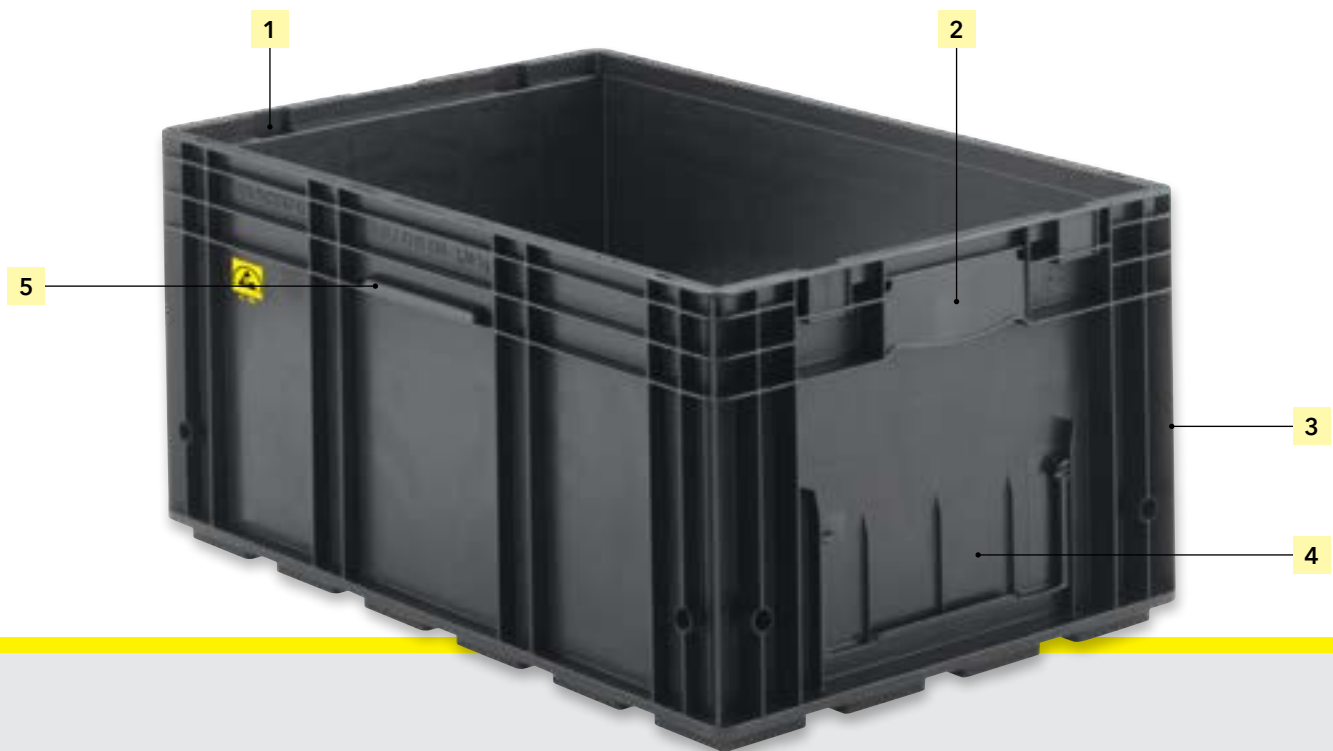

- 1| Lifting slots**
for vertical retrieval
- 2| Ergonomic underbarrel handle**
on short sides
- 3| Strong stacking corners**
for maximum stability
- 4| Label holders**
on one short and one long side
- 5| Additional grip**
on long sides



Standard colour:





Robust composite base
(max. load 20 kg)



VS01 vibration-welded base
(max. load 50 kg)

Our expertise: Plastic containers

Storage & transport containers for manual handling

Containers for semi- and fully automated systems

Space-saving containers

Containers for storing small parts

Industry solutions for the automotive industry



R-KLT, manufactured to the VDA 4504 standard

300 x 200 x 148 mm



KLT 3115 ESD

External dimensions L x W x H	297 x 198 x 147.5 mm
Internal dimensions L x W x H	243 x 162 x 144.8 mm
Usable height when stacked	129.5 mm
Capacity when stacked	5.3 litres
Load (max.)	20 kg
Live load (max.)	400 kg
Colour	Black, dissipative
Order no.	20888

400 x 300 x 148 mm



R-KLT 4115 ESD

External dimensions L x W x H	396 x 297 x 147.5 mm
Internal dimensions L x W x H	346 x 265 x 124.5 mm
Usable height when stacked	109.5 mm
Capacity when stacked	10.1 litres
Load (max.)	20 kg
Live load (max.)	600 kg
Colour	Black, dissipative
Order no.	20718

R-KLT 4129 ESD

External dimensions L x W x H	396 x 297 x 280 mm
Internal dimensions L x W x H	346 x 265 x 257.3 mm
Usable height when stacked	242.3 mm
Capacity when stacked	22.3 litres
Load (max.)	20 kg
Live load (max.)	600 kg
Colour	Black, dissipative
Order no.	20728

400 x 300 x 280 mm

**R-KLT 6115 ESD**

External dimensions L x W x H	594 x 396 x 147.5 mm
Internal dimensions L x W x H	544 x 364 x 124.5 mm
Usable height when stacked	109.5 mm
Capacity when stacked	21.8 litres
Load (max.)	20 kg
Live load (max.)	600 kg
Colour	Black, dissipative
Order no.	20798

600 x 400 x 148 mm



R-KLT, manufactured to the VDA 4504 standard

600 x 400 x 174 mm



R-KLT 6118 ESD**

External dimensions L x W x H	594 x 396 x 174 mm
Internal dimensions L x W x H	544 x 364 x 151 mm
Usable height when stacked	136 mm
Capacity when stacked	27.0 litres
Load (max.)	20 kg
Live load (max.)	600 kg
Colour	Black, dissipative
Order no.	79448*

R-KLT 6118 VS01 ESD** with vibration-welded base

Internal dimensions L x W x H	544 x 364 x 151 mm
Usable height when stacked	136 mm
Capacity when stacked	27.0 litres
Load (max.)	50 kg
Colour	Black, dissipative
Order no.	79458*

** without recommendation from German Association of the Automotive Industry (VDA)

600 x 400 x 214 mm



R-KLT 6122 ESD

External dimensions L x W x H	594 x 396 x 213.75 mm
Internal dimensions L x W x H	544 x 364 x 190.8 mm
Usable height when stacked	175.8 mm
Capacity when stacked	34.9 litres
Load (max.)	20 kg
Live load (max.)	600 kg
Colour	Black, dissipative
Order no.	79418

R-KLT 6122 VS01 ESD with vibration-welded base

Internal dimensions L x W x H	544 x 364 x 190.8 mm
Usable height when stacked	175.8 mm
Capacity when stacked	34.9 litres
Load (max.)	50 kg
Colour	Black, dissipative
Order no.	79428*

600 x 400 x 280 mm



R-KLT 6129 ESD

External dimensions L x W x H	594 x 396 x 280 mm
Internal dimensions L x W x H	544 x 364 x 257 mm
Usable height when stacked	242 mm
Capacity when stacked	48.1 litres
Load (max.)	20 kg
Live load (max.)	600 kg
Colour	Black, dissipative
Order no.	20738

R-KLT 6129 VS01 ESD** with vibration-welded base

Internal dimensions L x W x H	544 x 364 x 257 mm
Usable height when stacked	242 mm
Capacity when stacked	48.1 litres
Load (max.)	50 kg
Colour	Black, dissipative
Order no.	24618*

** without recommendation from German Association of the Automotive Industry (VDA)

Accessories

VDA-KLT-D 31 ESD drop-on lid 300 x 200 mm

Colour Black, dissipative

Order no. 20838

VDA-KLT-D 41 ESD drop-on lid 400 x 300 mm

Colour Black, dissipative

Order no. 20848

VDA-KLT-D 61 ESD drop-on lid 600 x 400 mm

Colour Black, dissipative

Order no. 20858

Lids



300 x 200 mm



400 x 300 mm

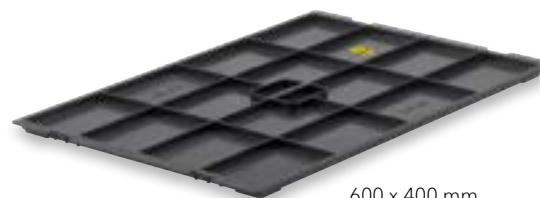

600 x 400 mm

A 1208-1 ESD pallet cover 1200 x 800 mm

Colour Black, dissipative

Order no. 35718*

Pallet cover



A 1208-1 ESD

RL-KLT, manufactured to the VDA 4500 standard

The RL-KLT container is a lighter version of the popular KLT model. In addition to its reduced weight, it boasts increased capacity - maximising efficiency in materials flow, logistics and transportation.

The RL-KLT's smooth base raises the amount of usable space within the container. What's more, its single-walled design proves to be particularly strong, thanks to built-in reinforcing struts.

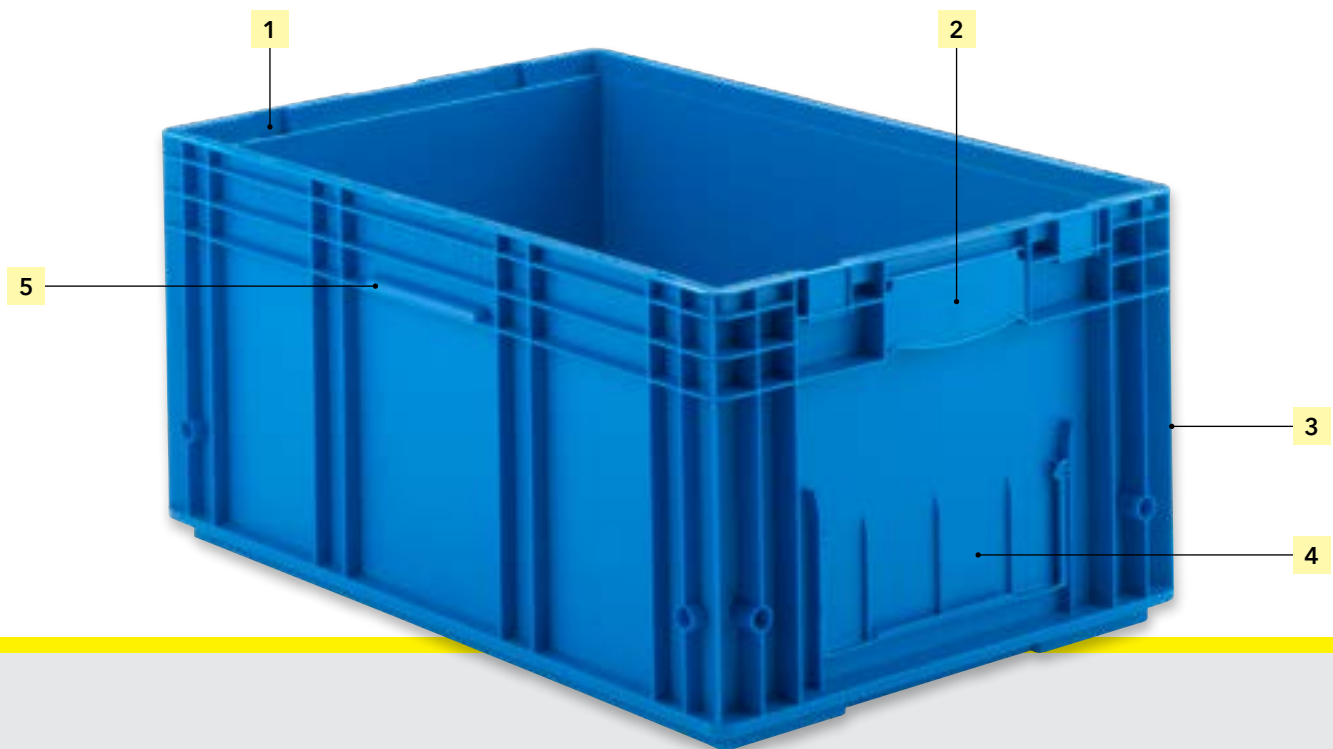

- 1| **Lifting slots**
for vertical retrieval
- 2| **Ergonomic underbarrel handle**
on short sides
- 3| **Robust stacking corners**
for maximum stability
- 4| **Label holders**
on one short and one long side
- 5| **Additional grip**
on long sides



Standard colour:

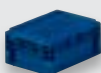

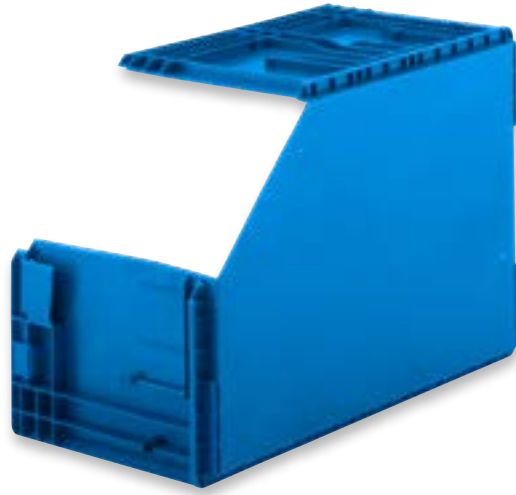

Smooth base
(max. load 20 kg)

Also available with drainage holes in the base, in accordance with the VDS directive for HHS 3 classification.



Our expertise: Plastic containers

Storage & transport containers for manual handling

Containers for semi- and fully automated systems

Space-saving containers

Containers for storing small parts

Industry solutions for the automotive industry

RL-KLT, manufactured to the VDA 4500 standard

300 x 200 x 148 mm



RL-KLT 3147 PP

External dimensions L x W x H	297 x 198 x 147.5 mm
Internal dimensions L x W x H	243 x 162 x 144.5 mm
Usable height when stacked	129.5 mm
Capacity when stacked	5.3 litres
Load (max.)	20 kg
Live load (max.)	400 kg
Colour	RAL 5005
Order no.	20744

400 x 300 x 148 mm



RL-KLT 4147 PP

External dimensions L x W x H	396 x 297 x 147.5 mm
Internal dimensions L x W x H	345 x 260 x 144.5 mm
Usable height when stacked	129.5 mm
Capacity when stacked	11.8 litres
Load (max.)	20 kg
Live load (max.)	600 kg
Colour	RAL 5005
Order no.	20754

RL-KLT 4280 PP

External dimensions L x W x H	396 x 297 x 280 mm
Internal dimensions L x W x H	345 x 260 x 277.3 mm
Usable height when stacked	262.3 mm
Capacity when stacked	24.2 litres
Load (max.)	20 kg
Live load (max.)	600 kg
Colour	RAL 5005
Order no.	20764

400 x 300 x 280 mm



RL-KLT 6147 PP

External dimensions L x W x H	594 x 396 x 147.5 mm
Internal dimensions L x W x H	544 x 359 x 144.5 mm
Usable height when stacked	129.5 mm
Capacity when stacked	25.7 litres
Load (max.)	20 kg
Live load (max.)	600 kg
Colour	RAL 5005
Order no.	20784

600 x 400 x 148 mm



Our expertise: Plastic containers

Storage & transport containers for manual handling

Containers for semi- and fully automated systems

Space-saving containers

Containers for storing small parts

Industry solutions for the automotive industry

RL-KLT, manufactured to the VDA 4500 standard

600 x 400 x 174 mm



RL-KLT 6174 PP**

External dimensions L x W x H	594 x 396 x 174 mm
Internal dimensions L x W x H	544 x 359 x 171 mm
Usable height when stacked	156 mm
Capacity when stacked	31.0 litres
Load (max.)	20 kg
Live load (max.)	600 kg
Colour	RAL 5005
Order no.	79434*

** without recommendation from German Association of the Automotive Industry (VDA)

600 x 400 x 214 mm



RL-KLT 6213 PP

External dimensions L x W x H	594 x 396 x 213.75 mm
Internal dimensions L x W x H	544 x 359 x 210.8 mm
Usable height when stacked	195.8 mm
Capacity when stacked	38.9 litres
Load (max.)	20 kg
Live load (max.)	600 kg
Colour	RAL 5005
Order no.	79404

** without recommendation from German Association of the Automotive Industry (VDA)

600 x 400 x 280 mm



RL-KLT 6280 PP

External dimensions L x W x H	594 x 396 x 280 mm
Internal dimensions L x W x H	544 x 359 x 277 mm
Usable height when stacked	262 mm
Capacity when stacked	52.1 litres
Load (max.)	20 kg
Live load (max.)	600 kg
Colour	RAL 5005
Order no.	20774

Accessories

RL-KLT-D 35 PP drop-on lid 300 x 200 mm	
Colour	RAL 5005
Order no.	20854
RL-KLT-D 45 PP drop-on lid 400 x 300 mm	
Colour	RAL 5005
Order no.	20834
RL-KLT-D 65 PP drop-on lid 600 x 400 mm	
Colour	RAL 5005
Order no.	20844

Lids

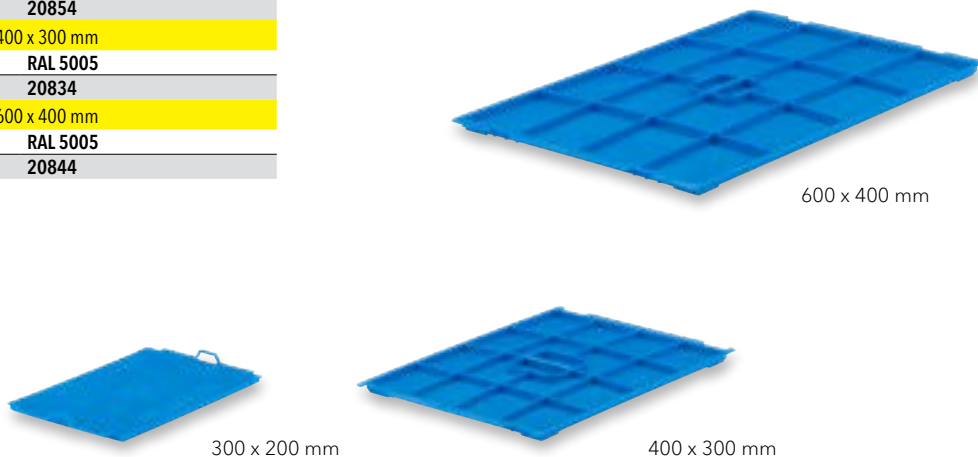

A 1208 PP** pallet cover 1200 x 800 mm	
Colour	RAL 5012
Order no.	39704
A 1208-1 PP pallet cover 1200 x 800 mm	
Colour	RAL 5012
Order no.	35614

Pallet covers

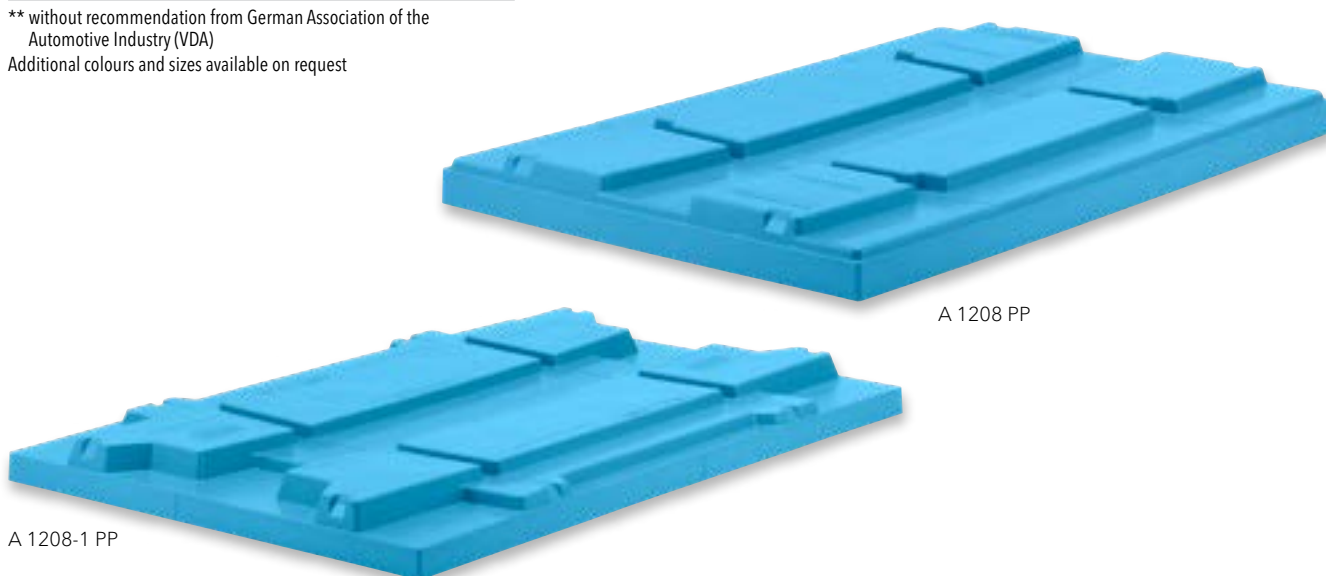

** without recommendation from German Association of the Automotive Industry (VDA)
 Additional colours and sizes available on request

Our expertise: Plastic containers

Storage & transport containers for manual handling

Containers for semi- and fully automated systems

Space-saving containers

Containers for storing small parts

Industry solutions for the automotive industry

RL-KLT with slide-in panel and accessories

300 x 200 x 147 mm



RL-KLT 3147-K1 PP** without slide-in panel

External dimensions L x W x H	297 x 198 x 147.5 mm
Internal dimensions L x W x H	243 x 162 x 144.5 mm
Usable height when stacked	129.5 mm
Capacity when stacked	5.3 litres
Load (max.)	20 kg
Live load (max.)	400 kg
Base type	smooth inner surface
Colour	RAL 5005
Order no.	8004*

RL-KLT 3147-K2 PP** without slide-in panel

Base type	rounded inner corners on removal side
Colour	RAL 5005
Order no.	8014*

RL-KLT 3147-K1-SK PP** with slide-in panel

Base type	smooth inner surface
Colour	RAL 5005
Order no.	8024*

RL-KLT 3147-K2-SK PP** with slide-in panel

Base type	rounded inner corners on removal side
Colour	RAL 5005
Order no.	8034*

RL32-SK65 PP** slide-in panel

External dimensions L x W x H	160 x 65 x 18 mm
Colour	Translucent
Order no.	8090*

** without recommendation from German Association of the Automotive Industry (VDA)

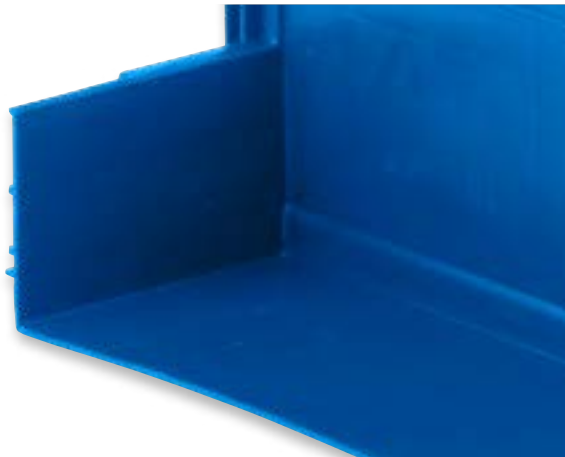

Standard interior



Rounded picking side

RL-KLT 4147-L1 PP** without slide-in panel

External dimensions L x W x H	396 x 297 x 147.5 mm
Internal dimensions L x W x H	345 x 260 x 144.5 mm
Usable height when stacked	129.5 mm
Capacity when stacked	11.8 litres
Load (max.)	20 kg
Live load (max.)	600 kg
Base type	smooth inner surface
Colour	RAL 5005
Order no.	8044*

RL-KLT 4147-L2 PP** without slide-in panel

Base type	rounded inner corners on removal side
Colour	RAL 5005
Order no.	8114*

RL-KLT 4147-L1-SK PP** with slide-in panel

Base type	smooth inner surface
Colour	RAL 5005
Order no.	8064*

RL-KLT 4147-L2-SK PP** with slide-in panel

Base type	rounded inner corners on removal side
Colour	RAL 5005
Order no.	8084*

RL43-SK65 PP** slide-in panel

External dimensions L x W x H	255 x 65 x 18 mm
Colour	Translucent
Order no.	8120*

** without recommendation from German Association of the Automotive Industry (VDA)

400 x 300 x 147 mm



RL-KLT-AD32-02 PP** drop-on lid 300 x 200 mm

for containers	RL-KLT 3147 K1 or K2
Colour	RAL 5005
Order no.	8454*

RL-KLT-AD32-04 PP** with clips

Colour	RAL 5005
Order no.	8414*

** without recommendation from German Association of the Automotive Industry (VDA)

RL-KLT-AD43-02 PP** drop-on lid 400 x 300 mm

for containers	RL-KLT 4147 L1 or L2
Colour	RAL 5005
Order no.	8464*

RL-KLT-AD43-04 PP** with clips

Colour	RAL 5005
Order no.	8474*

** without recommendation from German Association of the Automotive Industry (VDA)

Lids

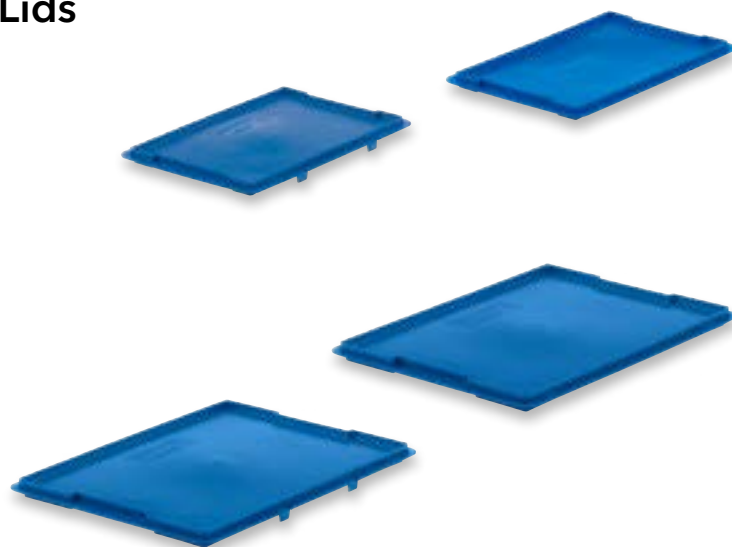

RL-KLT, manufactured to VDA 4504 - for electrostatic discharge

The ESD-safe version of the RL-KLT is designed for storing and conveying electronic components. This lightweight model is identical to the RL-KLT, but is made from a plastic with exceptional conductive properties.

ESD-safe containers provide highly effective protection for sensitive electronic components, preventing the build-up of electrostatic charge.



- 1| **Lifting slots**
for vertical retrieval
- 2| **Ergonomic underbarrel handle**
on short sides
- 3| **Strong stacking corners**
for maximum stability
- 4| **Label holders**
on one short and one long side
- 5| **Additional grip**
on long sides



Standard colour:





Smooth base
(max. load 20 kg)

Also available with drainage holes in the base, in accordance with the VDS directive for HHS 3 classification.



Our expertise: Plastic containers

Storage & transport containers for manual handling

Containers for semi- and fully automated systems

Space-saving containers

Containers for storing small parts

Industry solutions for the automotive industry

RL-KLT, manufactured to the VDA 4504 standard

300 x 200 x 148 mm



KLT 3115 ESD

External dimensions L x W x H	297 x 198 x 147.5 mm
Internal dimensions L x W x H	243 x 162 x 144.5 mm
Usable height when stacked	129.5 mm
Capacity when stacked	5.3 litres
Load (max.)	20 kg
Live load (max.)	400 kg
Colour	Black, dissipative
Order no.	20888

400 x 300 x 148 mm



RL-KLT 4047 ESD

External dimensions L x W x H	396 x 297 x 147.5 mm
Internal dimensions L x W x H	345 x 260 x 144.5 mm
Usable height when stacked	129.5 mm
Capacity when stacked	11.8 litres
Load (max.)	20 kg
Live load (max.)	600 kg
Colour	Black, dissipative
Order no.	20898

RL-KLT 4080 ESD

External dimensions L x W x H	396 x 297 x 280 mm
Internal dimensions L x W x H	345 x 260 x 277.3 mm
Usable height when stacked	262.3 mm
Capacity when stacked	24.2 litres
Load (max.)	20 kg
Live load (max.)	600 kg
Colour	Black, dissipative
Order no.	20908

400 x 300 x 280 mm

**RL-KLT 6047 ESD**

External dimensions L x W x H	594 x 396 x 147.5 mm
Internal dimensions L x W x H	544 x 359 x 144.5 mm
Usable height when stacked	129.5 mm
Capacity when stacked	25.7 litres
Load (max.)	20 kg
Live load (max.)	600 kg
Colour	Black, dissipative
Order no.	20868

600 x 400 x 148 mm



RL-KLT, manufactured to the VDA 4504 standard

600 x 400 x 174 mm



RL-KLT 6174 ESD**

External dimensions L x W x H	594 x 396 x 174 mm
Internal dimensions L x W x H	544 x 359 x 171 mm
Usable height when stacked	156 mm
Capacity when stacked	31.0 litres
Load (max.)	20 kg
Live load (max.)	600 kg
Colour	Black, dissipative
Order no.	79438*

** without recommendation from German Association of the Automotive Industry (VDA)

600 x 400 x 214 mm



RL-KLT 6013 ESD

External dimensions L x W x H	594 x 396 x 213.75 mm
Internal dimensions L x W x H	544 x 359 x 210.8 mm
Usable height when stacked	195.8 mm
Capacity when stacked	38.9 litres
Load (max.)	20 kg
Live load (max.)	600 kg
Colour	Black, dissipative
Order no.	1123618

600 x 400 x 280 mm



RL-KLT 6080 ESD

External dimensions L x W x H	594 x 396 x 280 mm
Internal dimensions L x W x H	544 x 359 x 277 mm
Usable height when stacked	262 mm
Capacity when stacked	52.1 litres
Load (max.)	20 kg
Live load (max.)	600 kg
Colour	Black, dissipative
Order no.	20878

Accessories

VDA-KLT-D 31 ESD drop-on lid 300 x 200 mm

Colour Black, dissipative

Order no. 20838

VDA-KLT-D 41 ESD drop-on lid 400 x 300 mm

Colour Black, dissipative

Order no. 20848

VDA-KLT-D 61 ESD drop-on lid 600 x 400 mm

Colour Black, dissipative

Order no. 20858

Lids



300 x 200 mm



400 x 300 mm

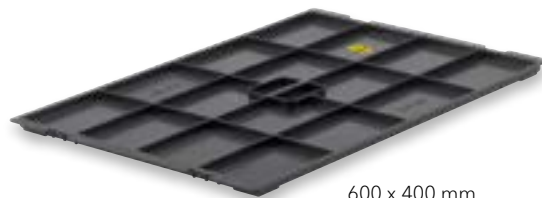

600 x 400 mm

A 1208-1 ESD pallet cover 1200 x 800 mm

Colour Black, dissipative

Order no. 35718*

Pallet cover



A 1208-1 ESD

C-KLT, manufactured to the VDA 4500 standard

The C-KLT is the classic among the KLTs. Millions of these tried-and-tested containers are in use at customer sites. The containers are exceptionally robust, reliable and stable when stacked, thanks to their full-surface composite bases.

Made from rigid plastic with a double-walled design and additional reinforcing struts, C-KLTs are exceptionally sturdy. Moreover, they are capable of handling heavy loads - of up to 50 kg.

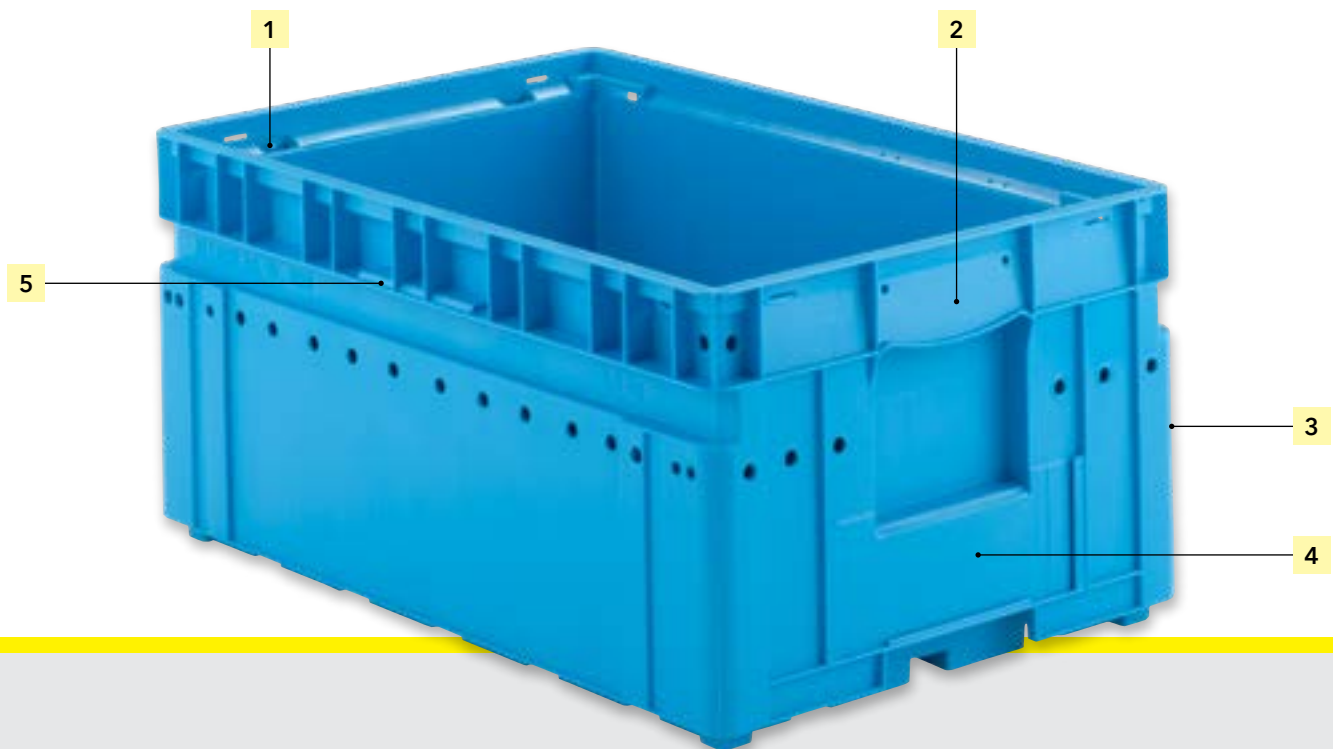

- 1| **Lifting slots**
for vertical retrieval
- 2| **Ergonomic underbarrel handle**
on short sides
- 3| **Strong corner columns**
for maximum stability
- 4| **Label holders**
on one short and one long side
- 5| **Additional grip**
on long sides



Standard colour:





Robust composite base
(max. load 50 kg)

Our expertise: Plastic containers

Storage & transport containers for manual handling

Containers for semi- and fully automated systems

Space-saving containers

Containers for storing small parts

Industry solutions for the automotive industry



C-KLT, manufactured to the VDA 4500 standard

300 x 200 x 148 mm



C-KLT 3214 PP

External dimensions L x W x H	297 x 198 x 147.5 mm
Internal dimensions L x W x H	260 x 136 x 144.9 mm
Usable height when stacked	129.9 mm
Capacity when stacked	4.7 litres
Load (max.)	30 kg
Live load (max.)	400 kg
Colour	RAL 5012
Order no.	15764

400 x 300 x 148 mm



C-KLT 4314 PP

External dimensions L x W x H	396 x 297 x 147.5 mm
Internal dimensions L x W x H	334 x 247 x 120.5 mm
Usable height when stacked	105.5 mm
Capacity when stacked	8.7 litres
Load (max.)	50 kg
Live load (max.)	600 kg
Colour	RAL 5012
Order no.	15774

400 x 300 x 214 mm



C-KLT 4321 PP

External dimensions L x W x H	396 x 297 x 213.75 mm
Internal dimensions L x W x H	334 x 247 x 186.8 mm
Usable height when stacked	171.8 mm
Capacity when stacked	14.2 litres
Load (max.)	50 kg
Live load (max.)	600 kg
Colour	RAL 5012
Order no.	1604

C-KLT 4328 PP

External dimensions L x W x H	396 x 297 x 280 mm
Internal dimensions L x W x H	334 x 247 x 253 mm
Usable height when stacked	238 mm
Capacity when stacked	19.6 litres
Load (max.)	50 kg
Live load (max.)	600 kg
Colour	RAL 5012
Order no.	15784

400 x 300 x 280 mm

**C-KLT 6414 PP**

External dimensions L x W x H	594 x 396 x 147.5 mm
Internal dimensions L x W x H	532 x 346 x 115.5 mm
Usable height when stacked	100.5 mm
Capacity when stacked	18.5 litres
Load (max.)	50 kg
Live load (max.)	600 kg
Colour	RAL 5012
Order no.	15804

600 x 400 x 148 mm

**C-KLT 6417 PP**

External dimensions L x W x H	594 x 396 x 174 mm
Internal dimensions L x W x H	532 x 346 x 142 mm
Usable height when stacked	127 mm
Capacity when stacked	23.4 litres
Load (max.)	50 kg
Live load (max.)	600 kg
Colour	RAL 5012
Order no.	1614

600 x 400 x 174 mm



C-KLT, manufactured to the VDA 4500 standard

600 x 400 x 280 mm



C-KLT 6428 PP

External dimensions L x W x H	594 x 396 x 280 mm
Internal dimensions L x W x H	532 x 346 x 248 mm
Usable height when stacked	233 mm
Capacity when stacked	42.9 litres
Load (max.)	50 kg
Live load (max.)	600 kg
Colour	RAL 5012
Order no.	15794

Accessories

ZL 43 PP layer separator 400 x 300 mm

Dimensions L x W x H 329 x 243 x 3 mm

Colour RAL 5012

Order no. 39684

ZL 64 PP layer separator 600 x 400 mm

Dimensions L x W x H 526.5 x 341.5 x 3 mm

Colour RAL 5012

Order no. 39694

Layer separators

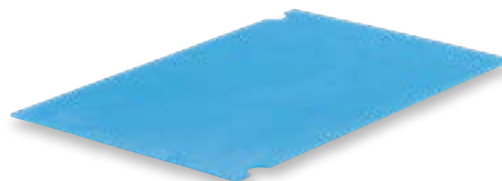

600 x 400 mm

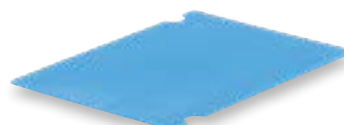

400 x 300 mm

C-KLT-D 32 PP drop-on lid 300 x 200 mm

Colour RAL 5012

Order no. 16514

C-KLT-D 43 PP drop-on lid 400 x 300 mm

Colour RAL 5012

Order no. 16414

C-KLT-D 64 PP drop-on lid 600 x 400 mm

Colour RAL 5012

Order no. 16424

Lids

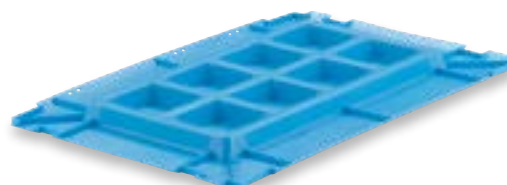

600 x 400 mm

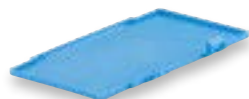

300 x 200 mm

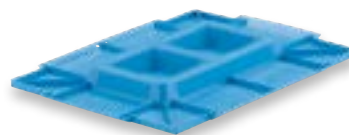

400 x 300 mm

Pallet covers, manufactured to VDA 4500 standard

1,200 x 800 mm

A 1208 PP** pallet cover 1200 x 800 mm	
Colour	RAL 5012
Order no.	39704
A 1208-1 PP pallet cover 1200 x 800 mm	
Colour	RAL 5012
Order no.	35614

** without recommendation from German Association of the Automotive Industry (VDA)
Additional colours and sizes available on request

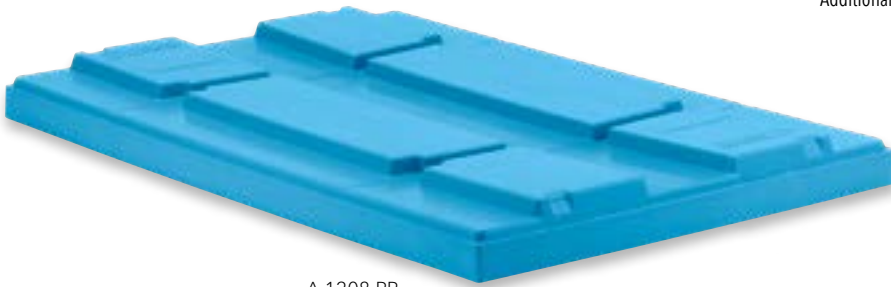

A 1208 PP

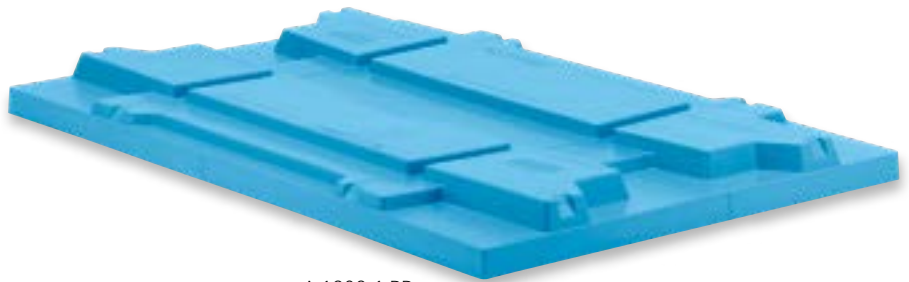

A 1208-1 PP

Industry solutions
for the automotive industry

Containers for storing small parts

Space-saving containers

Containers for semi- and
fully automated systems

Storage & transport containers
for manual handling

Our expertise: Plastic containers

Light KLT

In practice, only 20% of the classic KLT carry a load of 50 kg. Against this background, we developed the L-KLT model, designed to handle up to 20 kg. To create a more lightweight design, we eliminated both the double-walled structure and the composite base.

Light KLTs are easier to clean and convey, and have a reduced carbon footprint as a result. They offer 20 to 25 per cent greater useable volume. And thanks to their lightweight design, they are easier to handle on assembly lines and to return for reuse.

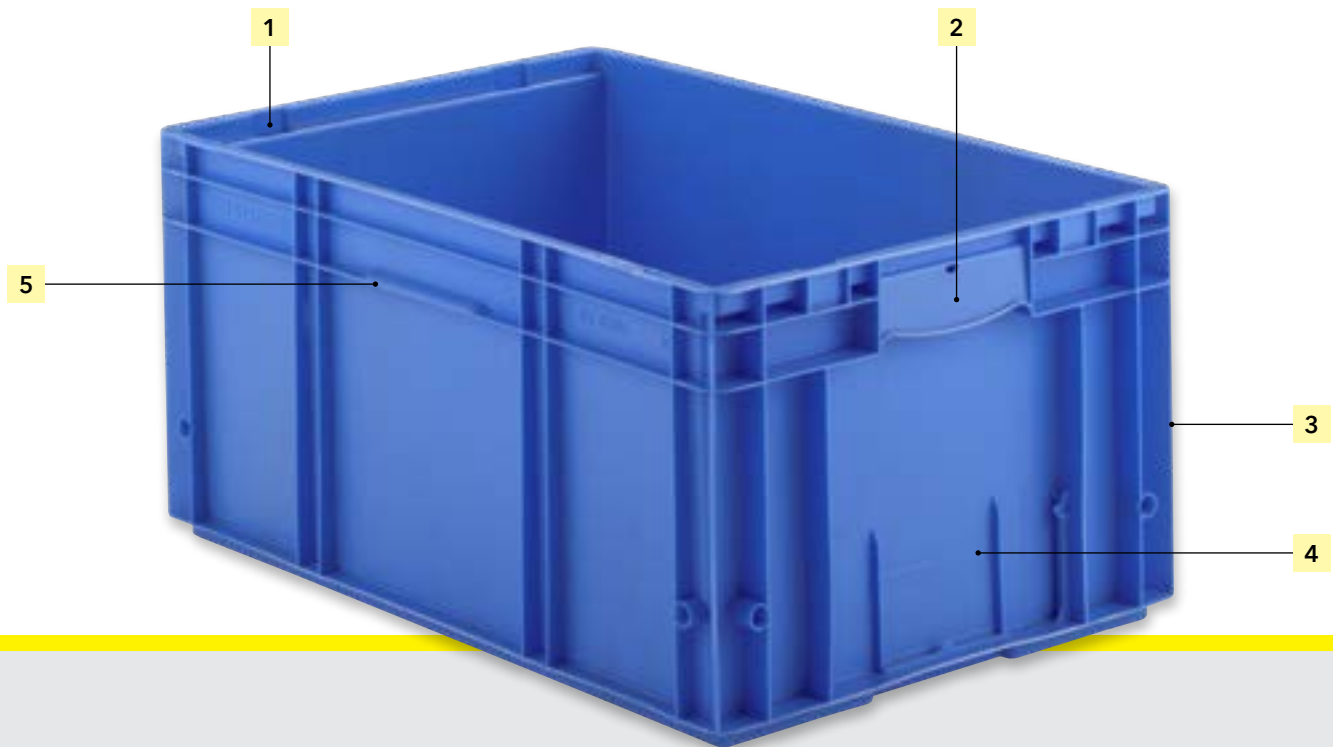

- 1| Lifting slots**
for vertical retrieval
- 2| Ergonomic underbarrel handle**
on short sides
- 3| Strong stacking corners**
for maximum stability
- 4| Label holders**
on one short and one long side
- 5| Additional grip**
on long sides



Standard colours:





Smooth base
(max. load 20 kg)

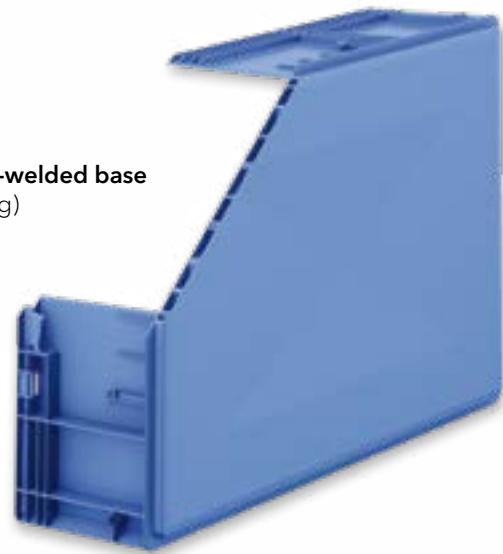

VS03 vibration-welded base
(max. load 50 kg)

Also available with drainage holes in the base, in accordance with the VDS directive for HHS 3 classification.

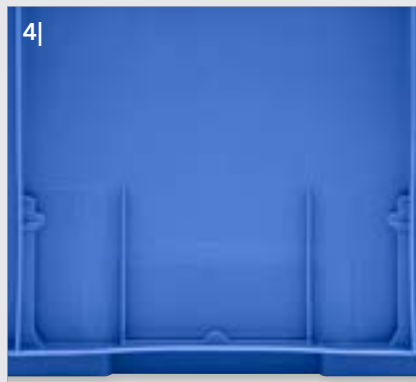

L-KLT

300 x 200 x 147 mm



L-KLT 3147 PP		
External dimensions L x W x H	297 x 198 x 147.5 mm	
Internal dimensions L x W x H	245 x 163 x 145 mm	
Usable height when stacked	130 mm	
Capacity when stacked	5.4 litres	
Load (max.)	20 kg	
Live load (max.)	400 kg	
Colour	Blue	Grey
Order no.	2174*	2175*
L-KLT 3147 PPL conductive model		
Colour	Black, dissipative	
Order no.	2178*	

400 x 300 x 147 mm



L-KLT 4147 PP		
External dimensions L x W x H	396 x 297 x 147.5 mm	
Internal dimensions L x W x H	344 x 261 x 144.5 mm	
Usable height when stacked	129.5 mm	
Capacity when stacked	11.7 litres	
Load (max.)	20 kg	
Live load (max.)	400 kg	
Colour	Blue	Grey
Order no.	2184*	2185*
L-KLT 4147 PPL conductive model		
Colour	Black, dissipative	
Order no.	2188*	

400 x 300 x 280 mm



L-KLT 4280 PP		
External dimensions L x W x H	396 x 297 x 280 mm	
Internal dimensions L x W x H	344 x 261 x 277 mm	
Usable height when stacked	262 mm	
Capacity when stacked	23.8 litres	
Load (max.)	20 kg	
Live load (max.)	400 kg	
Colour	Blue	Grey
Order no.	2104*	2105*
L-KLT 4280 PPL conductive model		
Colour	Black, dissipative	
Order no.	2108*	

L-KLT 6147 PP

External dimensions L x W x H	594 x 396 x 147.5 mm	
Internal dimensions L x W x H	543 x 360 x 144 mm	
Usable height when stacked	129 mm	
Capacity when stacked	25.5 litres	
Load (max.)	20 kg	
Live load (max.)	600 kg	
Colour	Blue	Grey
Order no.	2084*	2085*

L-KLT 6147 PPL conductive model

Colour	Black, dissipative	
Order no.	2088*	

600 x 400 x 147 mm

**L-KLT 6280 PP**

External dimensions L x W x H	594 x 396 x 280 mm	
Internal dimensions L x W x H	541 x 360 x 276.7 mm	
Usable height when stacked	261.7 mm	
Capacity when stacked	52.1 litres	
Load (max.)	20 kg	
Live load (max.)	600 kg	
Colour	Blue	Grey
Order no.	2194*	2195*

L-KLT 6280 PPL conductive model

Colour	Black, dissipative	
Order no.	2198*	

600 x 400 x 280 mm



L-KLT

800 x 600 x 66 mm



L-KLT 8066 PP

External dimensions L x W x H	794 x 596 x 66 mm	
Internal dimensions L x W x H	739 x 555 x 62 mm	
Usable height when stacked	44 mm	
Capacity when stacked	18.0 litres	
Load (max.)	20 kg	
Live load (max.)	600 kg	
Colour	Blue	Grey
Order no.	2074*	2075*

L-KLT 8066 VS03 PP with vibration-welded base

Internal dimensions L x W x H	739 x 555 x 45 mm	
Usable height when stacked	27 mm	
Capacity when stacked	11.0 litres	
Load (max.)	50 kg	
Colour	Blue	Grey
Order no.	86034*	86035*

L-KLT 8066 PPL conductive model

Colour	Black, dissipative	
Order no.	2078*	

800 x 600 x 120 mm



L-KLT 8120 PP

External dimensions L x W x H	794 x 596 x 120 mm	
Internal dimensions L x W x H	740 x 555 x 116 mm	
Usable height when stacked	98 mm	
Capacity when stacked	40.9 litres	
Load (max.)	20 kg	
Live load (max.)	600 kg	
Colour	Blue	Grey
Order no.	2064*	2065*

L-KLT 8120 VS03 PP with vibration-welded base

Internal dimensions L x W x H	740 x 555 x 99 mm	
Usable height when stacked	81 mm	
Capacity when stacked	33.8 litres	
Load (max.)	50 kg	
Colour	Blue	Grey
Order no.	86044*	86045*

L-KLT 8120 PPL conductive model

Colour	Black, dissipative	
Order no.	2068*	

800 x 600 x 210 mm



L-KLT 8210 PP

External dimensions L x W x H	794 x 596 x 210 mm	
Internal dimensions L x W x H	739 x 556 x 206 mm	
Usable height when stacked	188 mm	
Capacity when stacked	78.4 litres	
Load (max.)	20 kg	
Live load (max.)	600 kg	
Colour	Blue	Grey
Order no.	2044*	2045*

L-KLT 8210 VS03 PP with vibration-welded base

Internal dimensions L x W x H	739 x 556 x 189 mm	
Usable height when stacked	170 mm	
Capacity when stacked	70.9 litres	
Load (max.)	50 kg	
Colour	Blue	Grey
Order no.	2054*	2055*

L-KLT 8210 PPL conductive model

Colour	Black, dissipative	
Order no.	2048*	

L-KLT 8280 PP

External dimensions L x W x H	794 x 596 x 280 mm	
Internal dimensions L x W x H	739 x 556 x 276.2 mm	
Usable height when stacked	258.2 mm	
Capacity when stacked	107.6 litres	
Load (max.)	20 kg	
Live load (max.)	600 kg	
Colour	Blue	Grey
Order no.	20684*	20685*

L-KLT 8280 VS03 PP with vibration-welded base

Internal dimensions L x W x H	739 x 556 x 259 mm	
Usable height when stacked	241 mm	
Capacity when stacked	100.5 litres	
Load (max.)	50 kg	
Colour	Blue	Grey
Order no.	20694*	20695*

L-KLT 8280 PPL conductive model

Colour	Black, dissipative	
Order no.	20688*	

800 x 600 x 280 mm



Notes



A series of horizontal lines spaced evenly down the page, intended for writing notes.

Six reasons for using SSI SCHÄFER Plastics

- **Reliability**
Independent family business.
- **Value for money**
Durable and globally proven container solutions contribute to the success of our customers.
- **Quality**
Targeted quality management in accordance with recognised standards ensures the high reliability and resilience of our products.
- **Reliability**
With our own Customer Service & Support, we guarantee your long-term customer satisfaction.
- **Expertise**
Our knowledge and experience of containers, customers, industries and markets has been growing for over 50 years. Our customers benefit from our skill at solving their individual challenges.
- **Internationality**
A leading global supplier of innovative container systems and constructive packaging, as well as waste technology and recycling solutions with more than 1000 employees.

ssi-plastic.com

Container catalogue_2024/06 EN, © SSI SCHÄFER Plastics
We reserve the right to make technical changes to all products shown here. Any colour deviations of the products from the original are due to technical reasons. No liability accepted for printing errors.

SSI SCHÄFER